

Stryker Hand Plating System

System components

VariAx Hand Locking Plate Module
Profyle Hand Standard Plate Module
VariAx and VariAx 2 Screws



Contents

- 1. Introduction 3**

- 2. Plates**
 - 1.2mm XS Profyle Hand standard plates 4
 - 1.7mm S Profyle Hand standard plates 4
 - 1.7mm S VariAx Hand locking plates 4
 - 2.3mm M Profyle Hand standard plates 5
 - 2.3mm L Profyle Hand Compression plates 5
 - 2.3mm M Profyle Hand standard plates 5
 - 2.3mm M VariAx Hand locking plates 6

- 3. Screws**
 - 1.2mm VariAx bone screws 7
 - 1.4mm VariAx emergency screws 7
 - 1.7mm VariAx 2 bone screws 7
 - 1.7mm VariAx 2 locking screws 8
 - 1.9mm VariAx 2 emergency screws 8
 - 2.3mm VariAx 2 bone screws 8
 - 2.3mm VariAx 2 locking screws 9
 - 2.5mm VariAx 2 emergency screws 9

- 4. Instruments**
 - Twist drills 10
 - Countersinks 10
 - General instruments 10
 - Screwdrivers 11
 - Bone reduction instruments 11
 - Reduction forceps for lag screw osteosynthesis 11

- 5. Cases and trays**
 - Sterilization containers 12

The Stryker Hand Plating system enables you to create a personalized system to fit your surgical needs. It consists of two modules with interchangeable inlays:

The VariAx Hand Locking Plate Module offers the benefits of variable angled locking plates as well as non-locking plates and screws for 1.7mm and 2.3mm implant sizes.

The Profyle Hand Standard Plating Module offers non-locking plates and screws for 1.2mm, 1.7mm and 2.3mm implant sizes.

Hand screw platform

Non-locking



1.2mm screws
cross pin interface



Locking



Non-locking



1.7mm screws
T5 interface



Locking



Non-locking



2.3mm screws
T6 interface



Cross pin blade



T5 blade



T6 blade

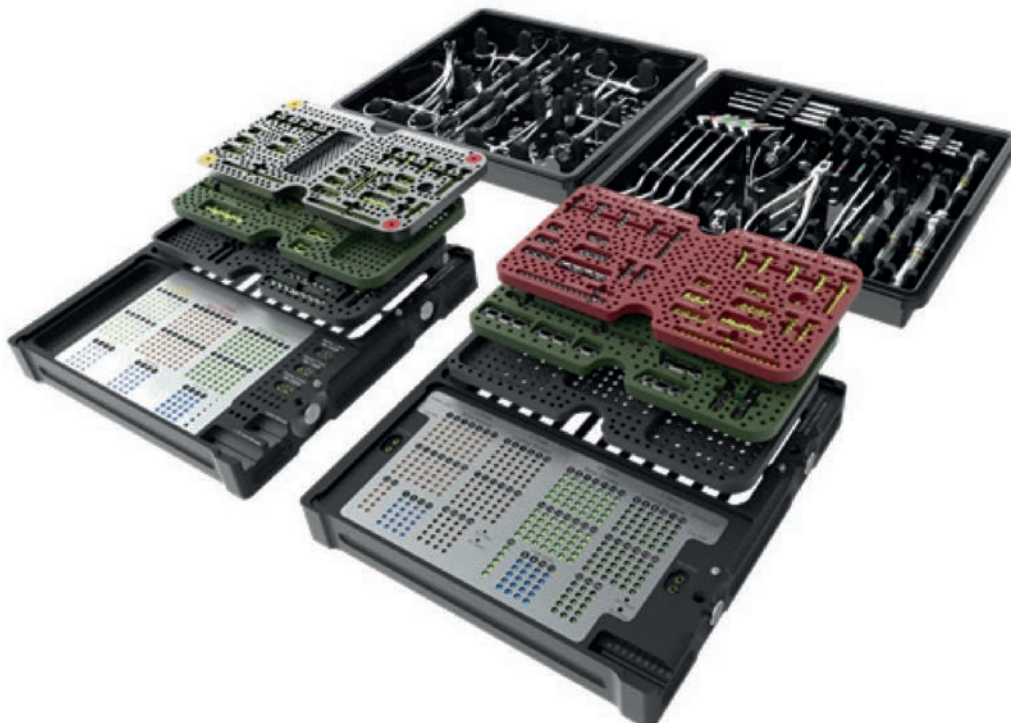

Implants – plates















**1.2mm XS Profyle Hand standard plates
(profile height 0.55mm)**

	Ref #	Description
	57-05101	4 Hole, Straight Plate
	57-05116	16 Hole, Straight Plate
	57-05140	5 Hole, Narrow, T-Plate
	57-05142	8 Hole, Narrow, T-Plate
	57-05150	5 Hole, Oblique, Right, T-Plate
	57-05151	5 Hole, Oblique, Left, T-Plate
	57-05170	5 Hole, Narrow, Y-Plate
	57-05190	2X2 Holes, 3D Plate
	57-05191	3X2 Holes, 3D Plate
	57-05192	4X2 Holes, 3D Plate
	57-05195	4X2 Holes, Replantation 3D Plate
	57-05197	2X2 + 2 Holes, 3D Plate

**1.7mm S Profyle Hand standard plates
(profile height 0.55mm)**

















	Ref #	Description
	57-05202	4 Hole, Straight Plate
	57-05216	16 Hole, Straight Plate
	57-05220	6 Hole, Right, L-Plate
	57-05221	6 Hole, Left, L-Plate
	57-05240	6 Hole, Narrow, T-Plate
	57-05260	7 Hole, T-plate
	57-05262	10 Hole, Narrow, T-Plate
	57-05270	7 Hole, Narrow, Y-Plate
	57-05279	9 Hole, Narrow, Z-Plate
	57-05282	5 Hole, Right, Blade Plate
	57-05283	5 Hole, Left, Blade Plate
	57-05285	1 Hole, Prong Plate
	57-05290	2X2 Holes, 3D Plate
	57-05291	3X2 Holes, 3D Plate
	57-05292	4X2 Holes, 3D Plate
	57-05295	4X2 Holes, Replantation 3D Plate
	57-05297	2X2+2 Holes, 3D Plate
	57-05210	8 Hole, Wide, T-Plate

**1.7mm S VariAx Hand locking plates
(profile height 1.0mm)**











	Ref #	Description
	57-10304	4 Hole, Straight Plate
	57-10316	16 Hole, Straight Plate
	57-10320	6 Hole, Right, L-Plate
	57-10321	6 Hole, Left, L-Plate
	57-10340	6 Hole, Narrow, T-Plate
	57-10360	7 Hole, T-plate
	57-10368	8 Hole, Wide, T-Plate
	57-10310	10 Hole, Narrow, T-Plate
	57-10379	9 Hole, Narrow, Z-Plate
	57-10390	2X2 Holes, 3D Plate
	57-10391	3X2 Holes, 3D Plate
	57-10392	4X2 Holes, 3D Plate
	57-10395	4X2 Holes, Replantation 3D Plate
	57-10397	2X2 + 2 Holes, 3D Plate
	57-10380	5 Hole, Rotation Plate

Implants – plates

**2.3mm M Profyle Hand standard plates
(profile height 1.0mm)**

	Ref #	Description
	57-10101	4 Hole, Straight Plate
	57-10102	4 Hole, Straight Plate with Bar
	57-10116	16 Hole, Straight Plate
	57-10120	6 Hole, Right, L-Plate
	57-10121	6 Hole, Left, L-Plate
	57-10140	6 Hole, Narrow, T-Plate
	57-10160	7 Hole, T-Plate
	57-10170	7 Hole, Narrow, Y-Plate
	57-10179	13 Hole, Narrow, Z-Plate
	57-10190	2X2 Holes, 3D Plate
	57-10191	3X2 Holes, 3D Plate
	57-10192	4X2 Holes, 3D Plate
	57-10195	4X2 Holes, Replantation 3D Plate
	57-10197	2X2 + 2 Holes, 3D Plate
	57-10161	8 Hole, Wide, T-Plate
	57-10185	5 Hole, Rotation Plate
	57-13185	5 Hole, Rotation Plate, Wide

**2.3mm L Profyle Hand Compression plates
(Profile Height 1.3mm)**



















	Ref #	Description
	57-13402	4 Hole, Straight Plate, Compression
	57-13405	5 Hole, Straight Plate, Compression
	57-13408	6 Hole, Straight Plate, Compression
	57-13410	8 Hole, Straight Plate, Compression
	57-13420	6 Hole, Right, L-Plate, Compression
	57-13421	6 Hole, Left, L-Plate, Compression
	57-13440	6 Hole, Narrow, T-Plate, Compression
	57-13442	10 Hole, Narrow, T-Plate, Compression
	57-13450	6 Hole, Oblique, Right, T-Plate, Compression
	57-13451	6 Hole, Oblique, Left, T-Plate, Compression
	57-13906	6 Hole, T-Plate, Compression

**2.3mm M Profyle Hand Compression plates
(profile height 1.0mm)**

	Ref #	Description
	57-10402	4 Hole, Straight Plate, Compression
	57-10407	6 Hole, Straight Plate, Compression
	57-10420	6 Hole, Right, L-Plate, Compression
	57-10421	6 Hole, Left, L-Plate, Compression
	57-10440	6 Hole, Narrow, T-Plate, Compression
	57-10460	7 Hole, T-Plate, Compression
	57-10470	7 Hole, Narrow, Y-Plate, Compression
	57-10482	6 Hole, Right, Condyle Plate, Compression
	57-10483	6 Hole, Left, Condyle Plate, Compression

Implants – plates

**2.3mm M VariAx Hand locking plates
(profile height 1.5mm)**

	Ref #	Description
	57-15301	4 Hole, Straight Plate
	57-15302	4 Hole, Straight Plate with Bar
	57-15316	16 Hole, Straight Plate
	57-15320	6 Hole, Right, L-Plate
	57-15321	6 Hole, Left, L-Plate
	57-15340	6 Hole, Narrow, T-Plate
	57-15361	8 Hole, Wide, T-Plate
	57-15360	7 Hole, T-Plate
	57-15370	7 Hole, Narrow, Y-Plate
	57-15379	13 Hole, Narrow, Z-Plate
	57-15390	2X2 Holes, 3D Plate
	57-15391	3X2 Holes, 3D Plate
	57-15392	4X2 Holes, 3D Plate
	57-15395	4X2 Holes, Replantation 3D Plate
	57-15397	2X2 + 2 Holes, 3D Plate
	57-15385	5 Hole, Rotation Plate
	57-15324	5 Hole, Left MC5 Plate
	57-15325	5 Hole, Right MC5 Plate

Implants — SCREWS**1.2mm VariAx bone screws**

1 per pack ref #	Length [mm]
58-12004E	4
58-12005E	5
58-12006E	6
58-12007E	7
58-12008E	8
58-12009E	9
58-12010E	10
58-12012E	12
58-12014E	14
58-12016E	16
58-12018E	18
58-12020E	20
59-12049E	Washer for 1.2mm Bone Screws

**1.4mm VariAx emergency screws**

1 per pack ref #	Length [mm]
58-14003E	3
58-14005E	5
58-14007E	7
58-14009E	9

1.7mm VariAx 2 bone screws

1 per pack ref #	Length [mm]
662605	5
662606	6
662607	7
662608	8
662609	9
662610	10
662611	11
662612	12
662613	13
662614	14
662615	15
662616	16
662618	18
662620	20
662622	22
662624	24
59-17049E	Washer for 1.7mm bone screws



Implants — SCREWS

1.7mm VariAx 2 locking screws



1 per pack ref #	Length [mm]
662505	5
662506	6
662507	7
662508	8
662509	9
662510	10
662511	11
662512	12
662513	13
662514	14
662515	15
662516	16
662518	18
662520	20
662522	22
662524	24

1.9mm VariAx 2 emergency screws



1 per pack ref #	Length [mm]
662705	5
662708	8
662710	10
662712	12

2.3mm VariAx 2 bone screws



1 per pack ref #	Length [mm]
663806	6
663807†	7
663808	8
663809	9
663810	10
663811	11
663812	12
663813	13
663814	14
663815	15
663816	16
663818	18
663820	20
663822	22
663824	24
663826†	26
663828†	28
663830†	30
663832†	32
663834†	34
663836†	36
663838†	38
663840S*	40
59-23049E	Washer for 2.3mm bone screw



*These items are available sterile packed only.

† These items are available sterile packed and non-sterile. For sterile packed product, add 'S' at the end of the reference.

Implants — SCREWS**2.3mm VariAx 2 locking screws**

1 per pack ref #	Length [mm]
663706	6
663707†	7
663708	8
663709	9
663710	10
663711	11
663712	12
663713	13
663714	14
663715	15
663716	16
663718	18
663720	20
663722	22
663724	24
663726†	26
663728S*	28
663730S*	30
663732S*	32
663734S*	34
663736S*	36
663738S*	38
663740S*	40

2.5mm VariAx 2 emergency screws













1 per pack ref #	Length [mm]
663906	6
663908	8
663910	10
663912	12

*These items are available sterile packed only.







† These items are available sterile packed and non-sterile. For sterile packed product, add 'S' at the end of the reference.

Instruments













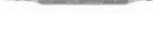

Twist drills

	Ref #	Description
	60-10122	1.0mm x 22mm, Stryker End
	60-10322	1.0mm x 22mm, AO End
	60-10422	1.0mm x 22mm, Dental End
	60-14126	1.4mm x 27mm, Stryker End
	60-14326	1.4mm x 27mm, AO End
	60-14426	1.4mm x 27mm, Dental End
	60-19126	1.9mm x 27mm, Stryker End
	60-19326	1.9mm x 27mm, AO End
	60-19426	1.9mm x 27mm, Dental End
	60-25126	2.5mm x 26mm, Lag Drill for 2.3mm Screws, Stryker End
	60-25326	2.5mm x 26mm, Lag Drill for 2.3mm Screws, AO End
	60-25426	2.5mm x 26mm, Lag Drill for 2.3mm Screws, Dental End

Countersinks













	Ref #	Description
	60-80112	1.2mm Countersink, Stryker End
	60-80312	1.2mm Countersink, AO End
	60-80412	1.2mm Countersink, Dental End
	60-80117	1.7mm Countersink, Stryker End
	60-80317	1.7mm Countersink, AO End
	60-80417	1.7mm Countersink, Dental End
	60-80123	2.3mm Countersink, Stryker End
	60-80323	2.3mm Countersink, AO End
	60-80423	2.3mm Countersink, Dental End

General instruments







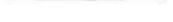



	Ref #	Description
	62-18110	Forceps to pick up implants
	01-08105	Self-Retaining Plate Forceps, Straight
	01-08115	Self-Retaining Plate Forceps, Angled
	62-51217	Standard Drill Guide 1.2mm/1.7mm
	62-52325	Standard Drill Guide 2.3mm/2.5mm
	62-52323	Compression Drill Guide 2.3 M/2.3 L
	62-51723	Polyaxial Locking Drill Guide, 1.7mm/2.3mm
	62-12112	1.2mm Depth Gauge
	62-17232	1.7mm/2.3mm Depth Gauge
	62-21723	Plate Benders for all plates
	62-20125	Plate Cutter for all plates
	60-80140	Burr for smoothing rough edges after cutting - Stryker End
	60-80333	Burr for smoothing rough edges after cutting - AO End
	60-80433	Burr for smoothing rough edges after cutting - Dental End

Instruments







Screwdrivers

	Ref #	Description
	62-12555	Screwdriver Handle for 1.2mm Screwdriver Blade
	62-23170	Screwdriver Handle for 1.7mm and 2.3mm Screwdriver Blade
	62-12050	Tension Plier for 1.2mm Screwdriver Blade (with 62-12055 creates grasping sleeve)
	62-17050	Tension Plier for 1.7mm Screwdriver Blade (with 62-17055 creates grasping sleeve)
	62-23050	Tension Plier for 2.3mm Screwdriver Blade (with 62-23055 creates grasping sleeve)
	62-12055	Tension Sheath for 1.2mm Screwdriver Blade (with 62-12050 creates grasping sleeve)
	62-17055	Tension Sheath for 1.7mm Screwdriver Blade (with 62-17050 creates grasping sleeve)
	62-23055	Tension Sheath for 2.3mm Screwdriver Blade (with 62-23050 creates grasping sleeve)
	62-12333	1.2mm Cross-Pin Screwdriver Blade
	705505	Screwdriver blade, 1.7mm, T5
	705506	Screwdriver blade, 2.3mm, T6
	62-12335	1.2mm Cross Pin Screw Removal Blade
	62-17335	1.7mm Cross Pin Screw Removal Blade
	62-23335	2.3mm Cross Pin Screw Removal Blade

Bone reduction instruments

	Ref #	Description
	07-30400	Auerbach Clamp
	07-30355	Lewin Bone Holding Forceps
	07-30111	Lewin Bone Holding Forceps, Sharp Tip
	07-30600	Lobster Claw
	07-10175	Bone Hook
	07-10021	Periosteal Elevator, 2-Sided, Strong Curve/Slight Curve
	07-10006	Hohmann Retractor, 2-Sided, Narrow/Wide
	07-30365	Verbrugge Forceps
	07-30350	Small Forceps
	07-30351	Medium Forceps

Reduction forceps for lag screw osteosynthesis*

	Ref #	Description
	07-30420	Drill Guide Clamp, curved right, 12.5cm
	07-30421	Drill Guide Clamp, curved left, 12.5cm (not ill.)
	07-30425	Drill Guide for 1.0mm Drill Bit 1.7mm
	07-30430	Screw Guide for 1.2mm Screw Dental End
	07-30426	Drill Guide for 1.4mm Drill Bit
	07-30431	Screw Guide for 1.7mm Screw
	07-30427	Drill Guide for 1.9mm Drill Bit
	07-30432	Screw Guide for 2.3mm Screw
	07-30428	Drill Guide for 2.5mm Drill Bit

*These are optional instruments and not included in the standard set content.

Cases and trays

Sterilization containers



1 per pack ref #

Description

29-12174

Profyle Hand Standard Plating Implant Module



29-17231

VariAx Hand Locking Plate Implant Module



29-51217

Inlay for 1.2mm XS/1.7mm S Profyle Hand Plates



29-50023

Inlay for 2.3mm M Profyle Hand Plates



29-50123

Inlay for 2.3mm M/2.3mm L Compression Plates

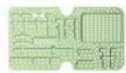

29-54023

Inlay for 2.3mm M VariAx Hand Plates



29-54017

Inlay for 1.7mm S VariAx Hand Plates



29-51717

Inlay for 1.7mm S Profyle Hand / 1.7mm VariAx Hand Plates





29-50000

Generic Inlay

Cases and trays

Sterilization containers (cont.)

	1 per pack ref #	Description
	29-13456	Instrument Tray
	29-13458	Bone Reduction Tray
	29-13009	4 Level Sterilizing Container, Half Size
	29-13013	3 Level Sterilizing Container, Half Size
	29-13010	Lid for Container, Half Size

Trauma & Extremities

This document is intended solely for the use of healthcare professionals. A surgeon must always rely on his or her own professional clinical judgment when deciding whether to use a particular product when treating a particular patient. Stryker does not dispense medical advice and recommends that surgeons be trained in the use of any particular product before using it in surgery.

The information presented is intended to demonstrate a Stryker product. A surgeon must always refer to the package insert, product label and/or instructions for use, including the instructions for cleaning and sterilization (if applicable), before using any Stryker product. Products may not be available in all markets because product availability is subject to the regulatory and/or medical practices in individual markets. Please contact your Stryker representative if you have questions about the availability of Stryker products in your area. Stryker Corporation or its divisions or other corporate affiliated entities own, use or have applied for the following trademarks or service marks: Profyle, Stryker, VariAx. All other trademarks are trademarks of their respective owners or holders.

This document is only approved for use in the USA.

Content ID: VAX-SCS-14_Rev-1, 01-2020

Copyright © 2020 Stryker



Manufacturer:

Stryker GmbH
Bohnackerweg 1
2545 Selzach
Switzerland

stryker.com