

stryker

ReUnion[®] RSA

Reverse Shoulder Arthroplasty System

Operative technique

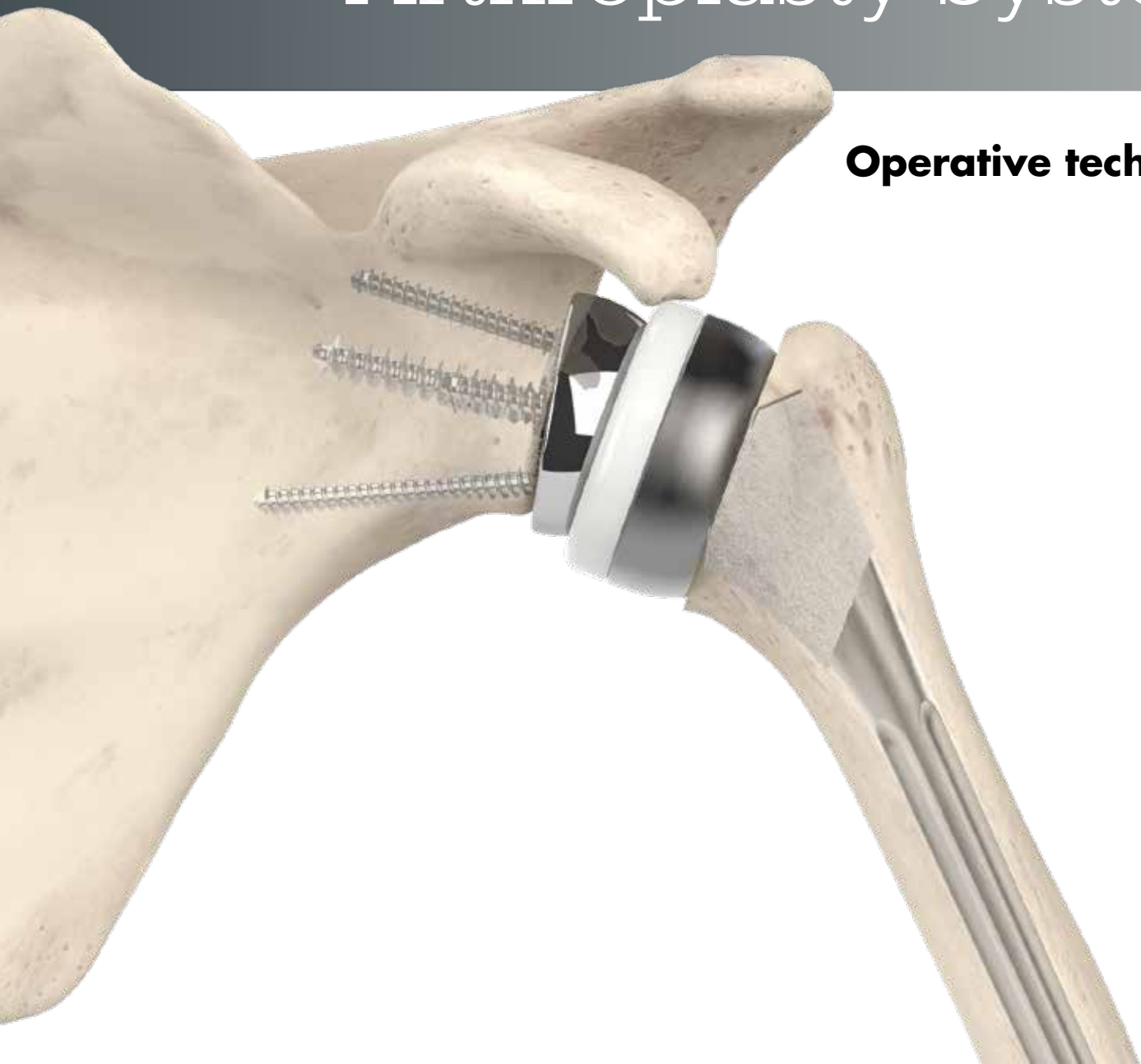

This publication sets forth detailed recommended procedures for using Stryker devices and instruments. It offers guidance that you should heed, but, as with any such technical guide, each surgeon must consider the particular needs of each patient and make appropriate adjustments when and as required.

A workshop training is recommended prior to performing your first surgery.

 **WARNING**

Follow the instructions provided in our cleaning and sterilization guide (OT-RG-1). All non-sterile devices must be cleaned and sterilized before use.

 **WARNING**

Multicomponent instruments must be disassembled for cleaning. Please refer to the corresponding assembly / disassembly instructions.

Please remember that the compatibility of different product systems has not been tested unless specified otherwise in the product labeling.

Consult Instructions for Use (www.ifu.stryker.com) for a complete list of potential adverse effects, contraindications, warnings and precautions.

The surgeon must advise patients of surgical risks and make them aware of adverse effects and alternative treatments.

 **WARNING**

The patient should be advised that the device cannot and does not replicate a normal healthy bone, that the device can break or become damaged as a result of strenuous activity or trauma and that the device has a finite expected service life. Removal or revision of the device may be required sometime in the future due to medical reasons.

ReUnion RSA

Reverse Shoulder Arthroplasty System

Operative technique	6	Humeral cup insert trialing	54
Patient positioning	8	Optional utilization of humeral cup trial adaptors	56
Surgical approach.....	9	Humeral cup/insert trialing	57
Pectoralis major tendon release	10	Expanding humeral trial.....	58
Subscapularis tendon release (capsulotomy)	11	Sliding humeral cup trial and humeral trial insert	60
Removal of osteophytes	12	Traditional humeral trialing (Humeral trial insert and humeral cup implant)	62
Superior-lateral approach	13		
Humeral head resection and canal reaming	14	Final implant insertion	64
Humeral Stem Options.....	15	Glenosphere placement.....	66
Instructions for extramedullary (EM) resection guide	16	Humeral cup and insert assembly	
Instructions for intramedullary (IM) resection guide	21	Press-fit stem application	67
Humeral head resection and canal reaming (superior-lateral approach).....	27	Options for cemented stem application	69
		Option 1: Complete back table assembly and monoblock insertion	72
		Option 2: Back table assembly of the humeral cup and cemented stem	70
		Option 3: In-vivo individual assembly of cemented humeral stem, humeral cup, and X3 humeral insert	74
Humeral preparation	32	Appendix	76
Broaching the humerus.....	34	Implant removal	
Osteotomy evaluation and calcar planing	37	Humeral stem removal	78
Humeral protector plate	38	Humeral poly insert removal.....	79
		Humeral cup removal	79
		Glenosphere removal	80
Glenoid preparation	40	Instrument disassembly	
Placement of the pilot wire.....	41	Disassembly of glenoid reamer/planar	81
Reaming and planing the glenoid	42	Humeral cup trial adaptor disassembly	82
Baseplate and center screw placement	46	Stem sizing chart	83
Preparation for peripheral screw placement	50		
Peripheral screw placement.....	52		
Glenosphere trialing.....	53		

Description and indications

Description

The ReUnion Reverse Shoulder is a system of components intended for total shoulder replacement in a reverse shoulder configuration. The system is comprised of a humeral cup, humeral insert, glenosphere, glenoid baseplate, and screws. This system is used with components from the following system:

- ReUnion Total Shoulder Arthroplasty (TSA) System (K103835)

Consult package label for accessory information.

Indications

The ReUnion RSA Shoulder System is intended for primary, fracture, or revision of total Shoulder replacement.

The patient's joint must have gross rotator cuff deficiency, a functional deltoid muscle and be anatomically and structurally suited to receive the selected implant(s).

- Painful, disabling joint disease of the shoulder resulting from: degenerative arthritis or rheumatoid arthritis.
- Proximal humeral fracture.
- Revision of previously failed shoulder joint replacement.

Glenoid Baseplate components are intended for cementless use with the addition of screw fixation.

The Humeral Stem components are intended for both cemented and cementless use.

In the case of revision, when ReUnion TSA humeral stems are well fixed, the system is indicated for conversion to a reverse shoulder arthroplasty.

In conjunction with ReUnion RSA humeral and glenoid components, ReUnion TSA humeral stems can be converted from a hemi or total shoulder arthroplasty to a reverse shoulder arthroplasty, as well as revised from an existing reverse shoulder arthroplasty to a secondary reverse shoulder arthroplasty, in treatment of a grossly deficient rotator cuff with severe arthropathy or previously failed joint replacement with a grossly deficient rotator cuff. The patient must have a functional deltoid muscle, and be anatomically and structurally suited to receive the implant(s).

Contraindications

- Any active or suspected latent infection in or about the shoulder joint.
- Any mental or neuromuscular disorder which would create an unacceptable risk of prosthesis instability, prosthesis fixation failure, or complications in postoperative care.
- Bone stock compromised by disease, infection or prior implantation which cannot provide adequate support and/or fixation to the prosthesis.
- Skeletal immaturity.
- Patients whose anticipated activities would impose high stresses on the prosthesis and its fixation.

CAUTION

MRI safety information

Non-clinical testing has demonstrated the ReUnion Reverse Shoulder Arthroplasty (RSA) system is MR Conditional. A patient with this device can be safely scanned in an MR system meeting the following conditions:

- Static magnetic field of 1.5 or 3.0 T
- Maximum spatial field gradient of 3,000 gauss/cm (30 T/m)
- Maximum MR system reported, whole body averaged specific absorption rate (SAR) of 2 W/kg (Normal Operating Mode)

Under the scan conditions defined above, the ReUnion RSA system is expected to produce a maximum temperature rise of less than 6.6°C after 15 minutes of continuous scanning.

In non-clinical testing, the image artifact caused by the device extends approximately 129.6mm from the ReUnion TSA system when imaged with a gradient echo pulse sequence and a 3.0T MRI system.

Warning

Consult Instructions for Use (www.ifu.stryker.com) for a complete list of potential adverse effects, contraindications, warnings and precautions.

Patient counseling

Surgeons should discuss all relevant contraindications, adverse effects and the need for post-implantation protection with their patients.

Operative technique

Operative technique

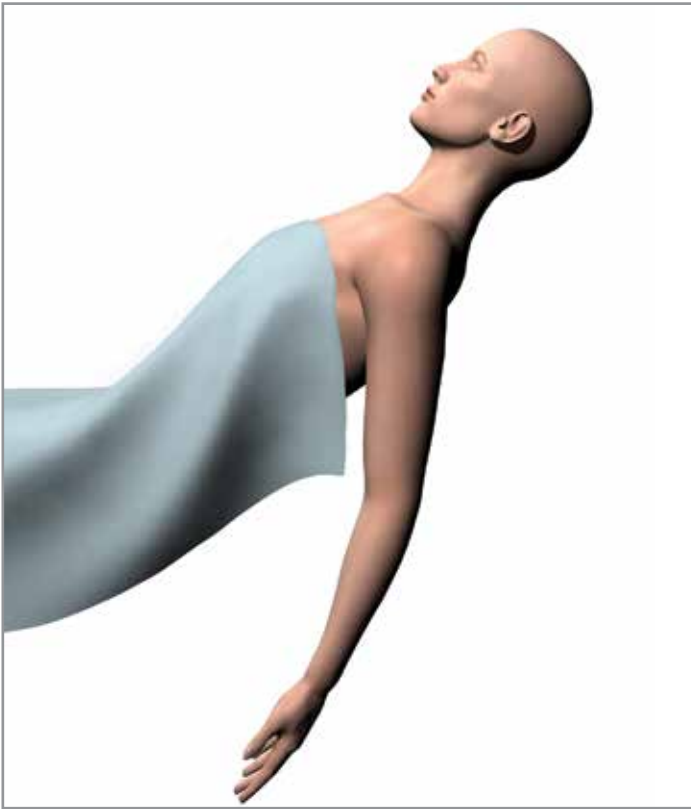

Figure 1

Patient positioning

For standard shoulder arthroplasty, the patient is positioned in a semi-Fowler's (beach chair) position. The torso is inclined 30° to 45° and the legs are padded and bent. The patient's shoulder is brought to the edge of the table to allow full extension of the arm, thus affording exposure of the humeral shaft. A bolster may be placed beneath the involved scapula to improve exposure of the articular surface.

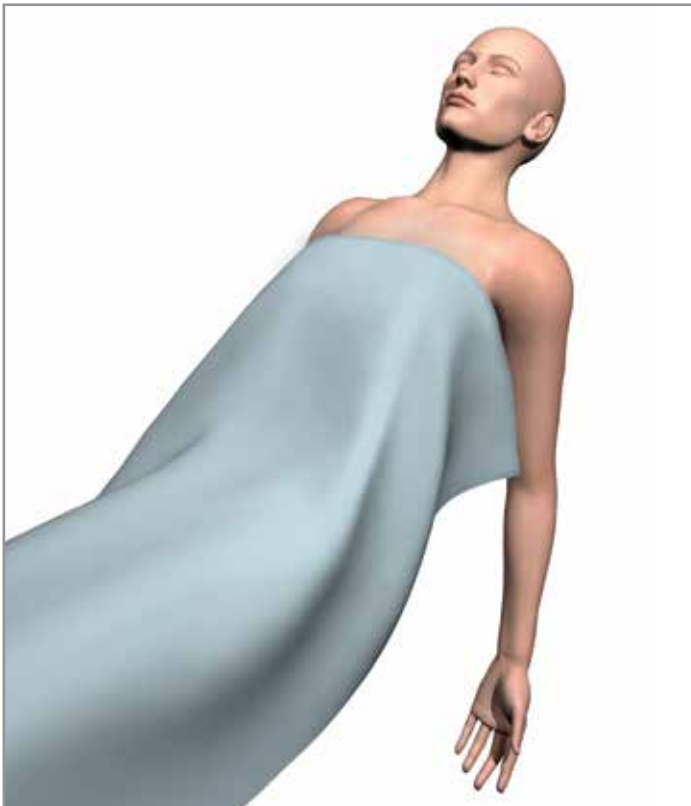

Figure 2

The head is stabilized to avoid movement during the procedure. It is recommended that anesthesia be brought to the contralateral side of the table to allow full access to the surgical field.

Tech tip:
Consideration may be given to a commercially available beach chair positioner.

Operative technique

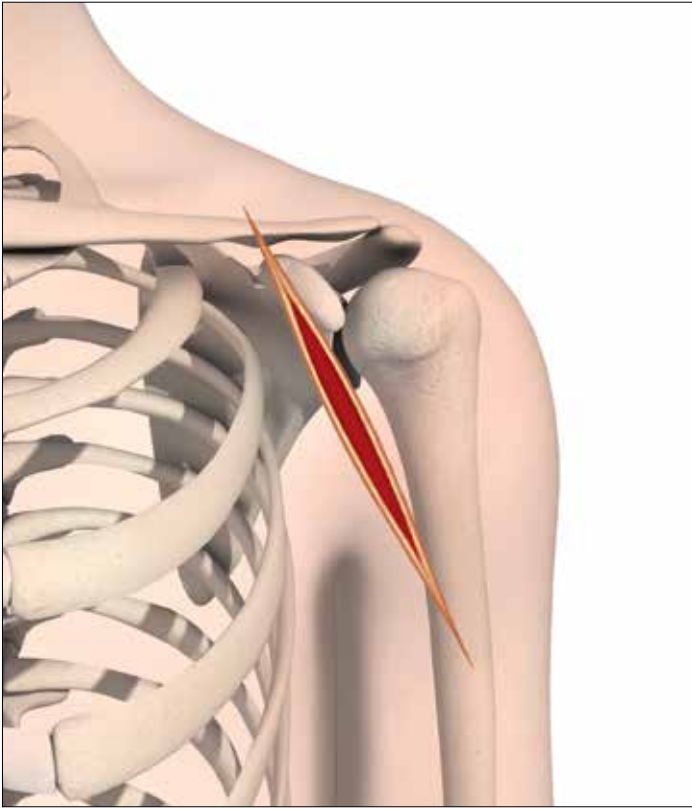

Figure 3

Surgical approach

For most cases, an extended delto-pectoral incision will be adequate to allow exposure to all involved structures. This begins 3-4cm medial to the acromioclavicular joint coursing distally over the coracoid process and along the delto-pectoral interval. You will note that the cephalic vein is medial to the coracoid.

Other surgical approaches may also be suitable for exposure of the surgical site.

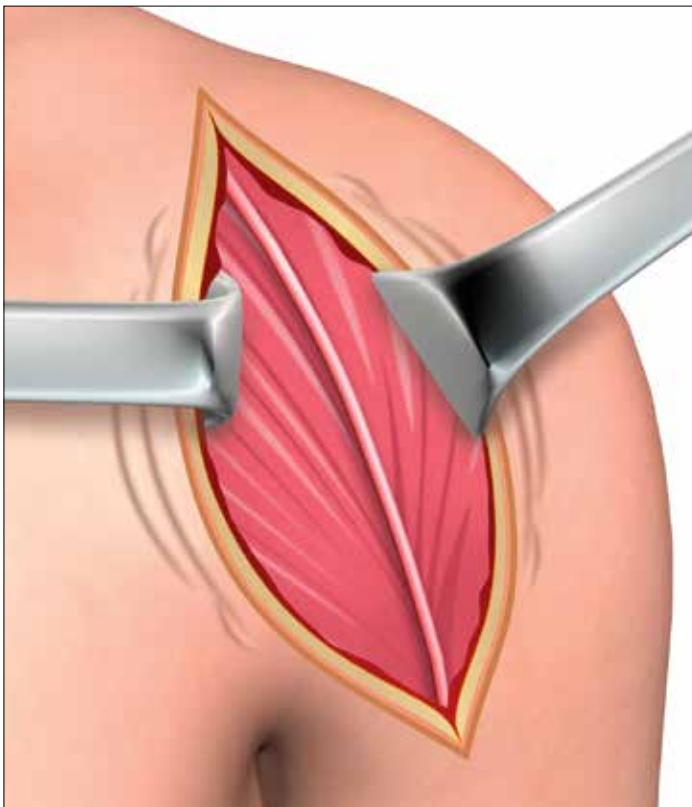

Figure 4

The incision is then taken down through subcutaneous tissue to the delto-pectoral interval. The cephalic vein is identified and usually taken laterally with the deltoid to preserve the lateral perforators.

Operative technique

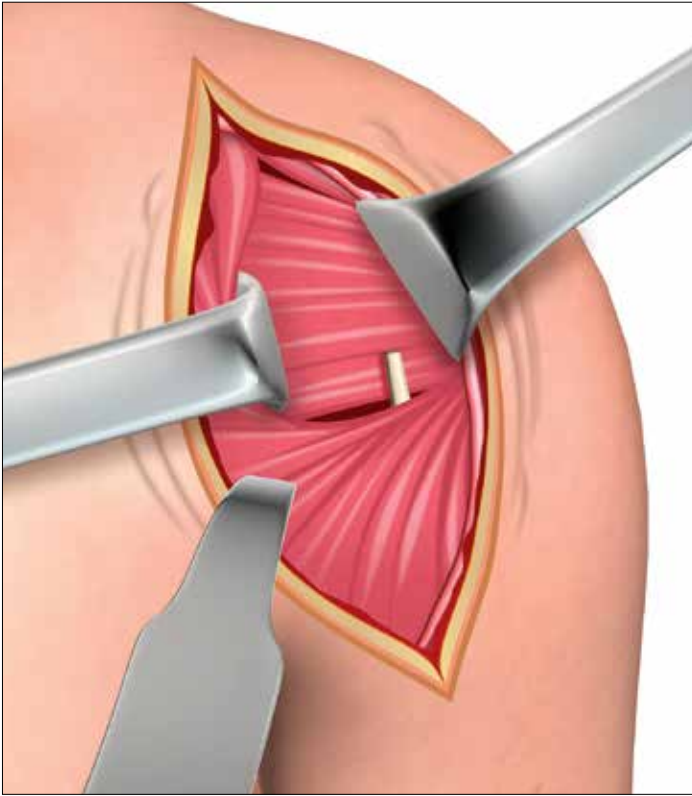

Figure 5

Pectoralis major tendon release

A self-retaining or Richardson type retractor may be placed beneath the pectoralis medially and the deltoid laterally. The conjoined tendons, as they originate from the coracoid process, are identified and the interval deep to the tendons and superficial to the subscapularis is carefully developed by finger dissection. The medial retractor can be repositioned in this interval, respecting the musculocutaneous nerve and other neurovascular structures medially.

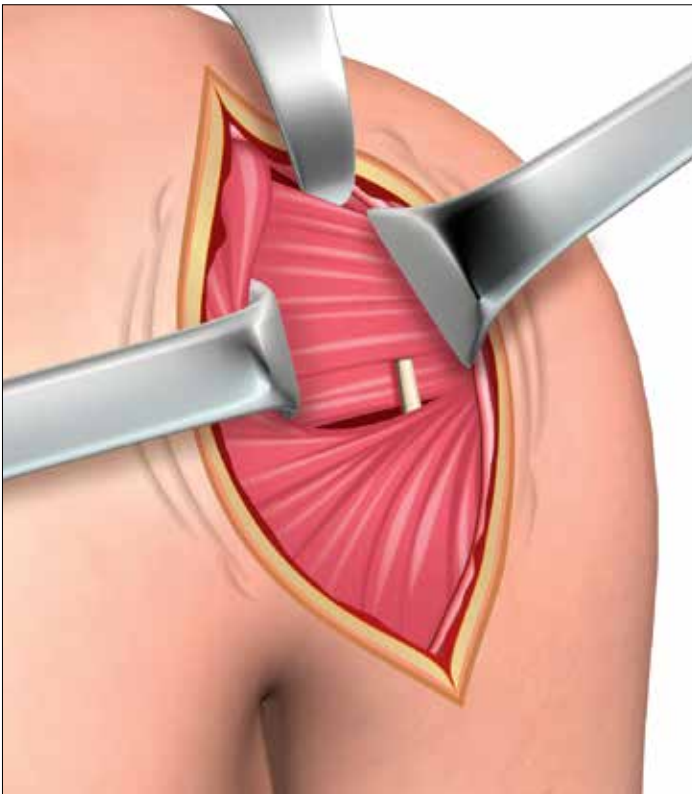

Figure 6

A blunt retractor is then passed superiorly beneath the coracoacromial ligament and acromion and superficial to the rotator cuff tendons. This allows additional exposure of the rotator interval and the anterior capsule.

Operative technique

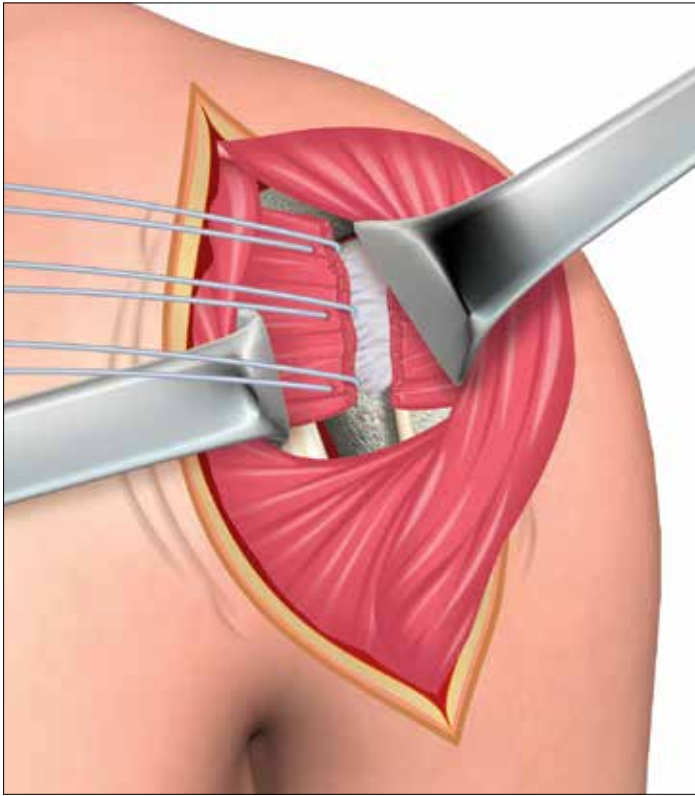

Figure 7

Subscapularis tendon release (capsulotomy)

Prior to performing the anterior capsulotomy for exposure, the surgeon should determine the amount of passive external rotation available given the degree of soft tissue contracture or bony deformity.

In most cases, a full thickness capsulotomy releasing both subscapularis and capsule simultaneously may be performed for exposure.

The vertical limb of the capsulotomy begins 1.5cm-2cm medial to the biceps tendon. This runs from the rotator interval, superiorly to the inferior margin of the subscapularis tendon distally.

A horizontal limb, both superiorly and inferiorly, is then created and traction sutures are placed.

Tech tip:
Placement of traction sutures in the tendon aids in its release.

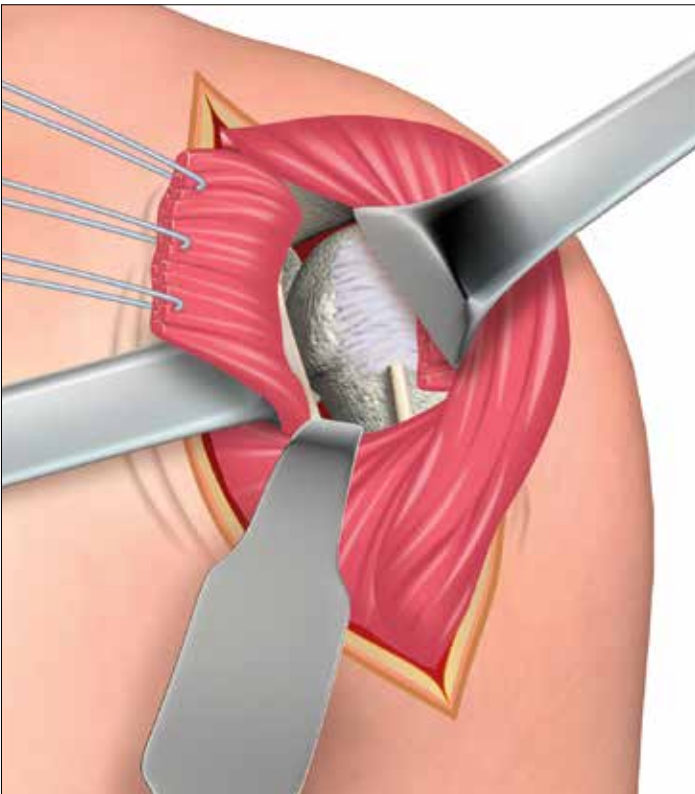

Figure 8

In most cases of arthritis of the glenohumeral joint, osteophytic spurring on the inferior portion of the humeral head will result in capsular shortening, loss of external rotation, and will necessitate release to allow exposure of the humeral head.

This is best accomplished by placing a retractor within the capsule at the inferior margin of the humeral head, externally rotating the arm, adducting and releasing that capsule intra-articularly, thus avoiding injury to the extracapsular axillary nerve. This step is critical in gaining exposure.

NOTICE

A constant understanding of the location of the axillary nerve is critical during exposure.

Operative technique

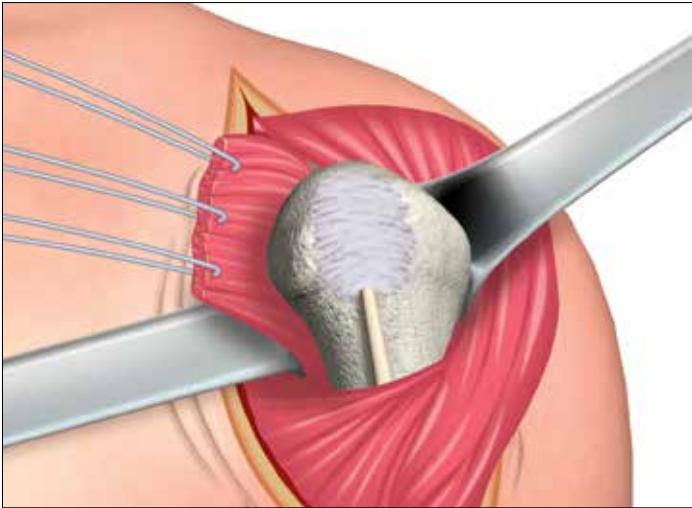

Figure 9

Removal of osteophytes

With the capsulotomy complete, the humeral head can be dislocated with external rotation and a pull from behind the proximal arm, delivering the humerus anterior and lateral.

Osteophytes are removed inferiorly and anteriorly to determine the level of head resection, and to define the anatomic neck and articular margins.



Figure 10

The humeral resection may be performed using either an intramedullary or extramedullary resection guide. Both methods are described below.

This step is critical in determining the orientation of the humeral head in relation to the glenoid. Furthermore, the extent of osteophytes, loose bodies, and humeral head deformation needs to be determined pre-operatively with templating and radiographic studies.

Operative technique

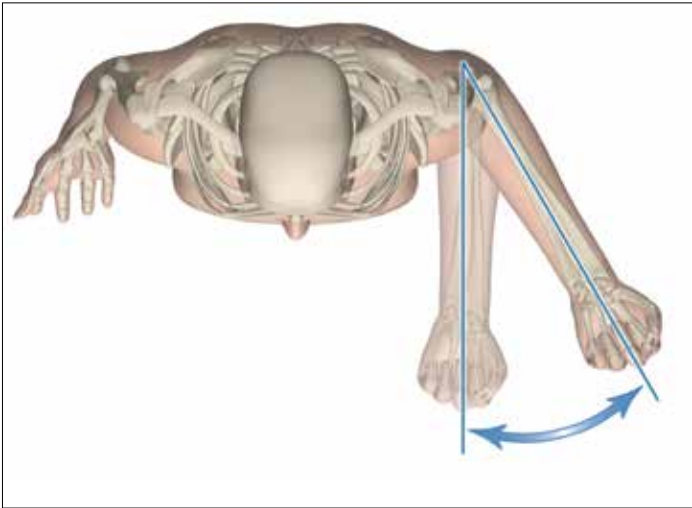

Figure 11

In most cases, the humeral component should be set in approximately 30° of retroversion. There are a number of techniques that may be employed to achieve this retroversion. By flexing the elbow 90° and externally rotating the arm 30°, the humeral head cut is made straight on, thereby achieving 30° of retroversion.

Superior-lateral approach

The skin incision is made along the lateral edge of the acromion or made in a lateral direction. Following subcutaneous dissection, the anterior and middle deltoid muscle portions opposite the lateral margin of the acromion are separated using blunt dissection. The dissection starts at the level of the AC joint, 5-7mm posterior to the tip of the acromion, and extends straight laterally down into the deltoid muscle. It should not extend more than 4cm from the external aspect of the acromion in order to preserve the axillary nerve which is located at the turning fold of the subacromial bursa.

When the subacromial bursa is visible, gentle longitudinal traction in line with the limb allows a retractor to be placed in the subacromial space. The humeral head is dislocated and the proximal humerus will protrude through the rotator cuff defect. Exposure may be optimized, if necessary, by releasing the anterior border and the rest of the superior cuff.

Humeral head resection and canal reaming

Humeral stem options



**Standard
Stem**



**ReUnion S
Stem**

Within this operative technique there are two humeral stem options: standard ReUnion TSA stems and ReUnion S stems. The standard stems are conventional in length while the ReUnions S stems are SOMA designed to be the ideal length stem, optimizing both bone preservation and stability.

While the ReUnion S stem is shorter in length compared to the standard stems, both stems share nearly the same instrumentation and surgical workflow. The following instructions apply to both standard and ReUnion S stems with the exception of the Humeral Canal Reaming and Humeral Broaching steps where stem specific instrumentation must be used.

*Stryker Internal Document: A0024172

Humeral head resection and canal reaming



Figure 12

Instructions for extramedullary (EM) resection guide

Once the margin of the articular surface is determined, the extramedullary humeral resection guide should be placed on the anterior aspect, parallel to the long axis of the humeral shaft.

Adjust the cutting block to the proper angular stop, left or right and verify that the resection block is fully against the stop, prior to tightening the locking knob.

NOTICE

The correct height is determined superior-laterally by the attachment of the supraspinatus tendon.

CAUTION

The cut should be at the margin of the cuff attachment, removing the articular surface, but preserving the tendon attachment. Care should be taken to protect the biceps tendon and rotator cuff insertion with a small Hohman, Bennett or Crego retractor during head resection.

Accurate retroversion of the cut will remove all of the articular surface posteriorly, but preserve the posterior capsule and cuff attachments.



Figure 13

Humeral head resection and canal reaming



Figure 14

Prior to headless pin insertion, ensure that the arm is in proper retroversion using the 30° version rod and setting the arm in correct retroversion.

The version rod should align with the patient's forearm.



Figure 15

When the correct retroversion has been determined, pin the external humeral resection guide to the humeral shaft using the headless pins inserted at slightly diverging angles.

If desired, mark the angle of the resection at a height appropriate for the desired head resection.

The angle of resection (135°) is marked and the humeral cut is initiated.

NOTICE

Remove the version rod prior to initiating resection.

WARNING

Do not use the version rod to rotate the assembly.

Humeral head resection and canal reaming

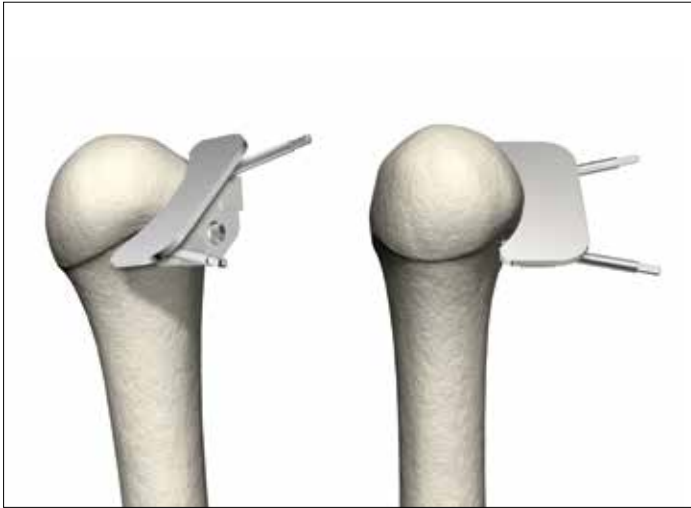

Figure 16

Once pinned in place, the knob can be loosened and the vertical shaft of the EM cutting guide can be removed to improve access for making the resection.

Place the oscillating saw blade along the flat surface of the guide and complete the humeral head resection.

NOTICE

A sagittal sawblade that has a width of ½" (12mm) or less is desirable.

Ensure that the blade is oscillating prior to coming in contact with bone.

Inspect sawblade for any defects prior to utilization.

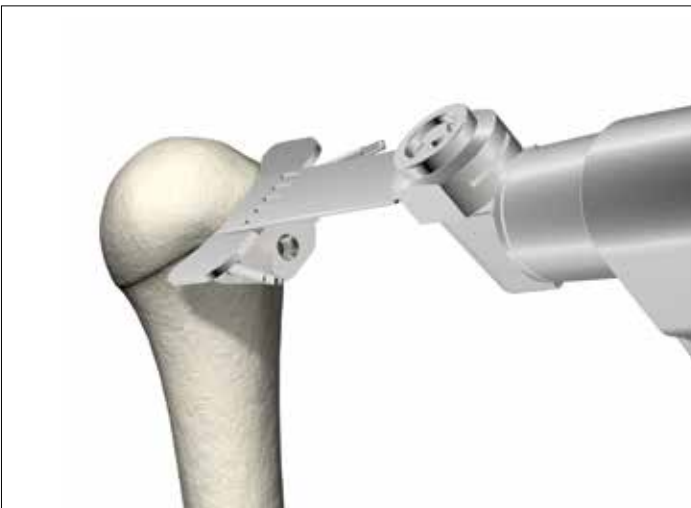

Figure 17

The guide can be removed and the cut completed freehand or refined with a rongeur; any residual osteophytes, especially posteriorly, should be resected using an osteotome.

The resected head should be saved for later comparison and sizing of the modular humeral head options, as well as a source for bone graft.

NOTICE

The saw blade should remain flush against the resection plane of the resection guide prior to initiating the humeral head resection.



Figure 18

Once the cut has been completed, remove the headless pins using the headless pin removal tool and then the cutting block.

Humeral head resection and canal reaming



Figure 19

Retractors are placed beneath the rotator cuff tissue superiorly and medially to provide adequate exposure of the canal for reaming. Reaming begins with bullet-tip fluted cylindrical reamers.

Placement should be somewhat lateral and just posterior to the bicipital groove. This will allow for appropriate position within the canal.

Reaming should be performed manually using the quick release ratcheting T-handle and be progressive in size (i.e. 7mm, 8mm, 9mm, etc) until friction is felt as the reamer contacts cortical bone.

CAUTION

It is important not to let the coracoid / conjoined tendon crowd posterior humeral metaphysis and force your canal entry too anterior.

NOTICE

Ensure that standard canal reamers are only used with standard stems and ReUnion S canal reamers are only used with ReUnion S stems.

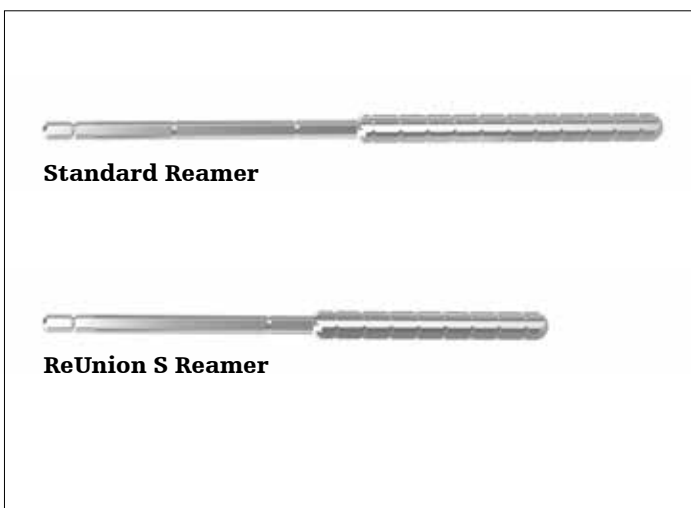

Figure 20

Humeral head resection and canal reaming

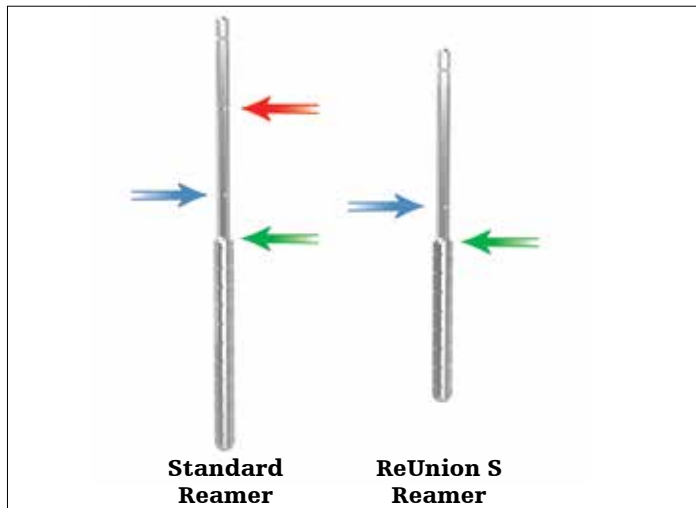

Figure 21

The following steps are performed once the humeral head has been resected.

For a press-fit stem or cemented stem without a cement restrictor, the reamer should be inserted to the top of the cutting teeth (Figure 21, green arrow).

If a cemented stem with a cement restrictor is going to be utilized, the reamer should be inserted to the depth of the first line above the cutting teeth (Figure 21, blue arrow).

If a ReUnion TSA long stem prosthesis is indicated, reaming depth is to the second line positioned near the top of the standard reamer shaft (Figure 21, red arrow).

NOTICE

These engraved marks are only present on reamer sizes 8 and above.

The last reamer size used will match the distal size of the broach to be used.

WARNING

The slotted mallet should not be utilized to strike the underside of the ratcheting T-handle for extraction or removal of the starter awl or cylindrical reamers.

Humeral head resection and canal reaming



Figure 22

Instructions for intramedullary (IM) resection guide

NOTICE

Ensure that standard canal reamers are only used with standard stems and ReUnion S canal reamers are only used with ReUnion S stems.

Assemble the 6mm starter awl and the ratcheting T-handle. Place the tip of the starter awl in line with the long axis of the humerus and bore a pilot hole through the humeral head along the long axis.

Placement should be somewhat lateral and just posterior to the bicipital groove. This will allow for appropriate valgus position within the canal.

The entry point is made posterior to the bicipital groove, relatively lateral on the head's articular surface and just medial to the rotator cuff attachment. Using a mallet, lightly tap the awl into the canal.

The starter awl can be impacted through the humeral head starting position using the mallet to impact on the metal pad of the T-handle.

NOTICE

The T-handle can be placed into three different positions marked on the collar near the silicone handle. These positions are marked as "R" for REVERSE, "L" for LOCKED, and "F" for FORWARD. The user should align the white arrow marker with the appropriate directional setting during use.

Manually insert the starter awl until the larger diameter portion (positive stop) above the cutting teeth is located just above the humeral head.

CAUTION

It is important not to let the coracoid / conjoined tendon crowd posterior humeral metaphysis and force your canal entry too anterior.

Once the entry point has been made through the humeral canal, remove the 6mm starter awl and begin to ream the humeral canal with the fluted cylindrical humeral reamers.



Figure 23

Humeral head resection and canal reaming



Figure 24

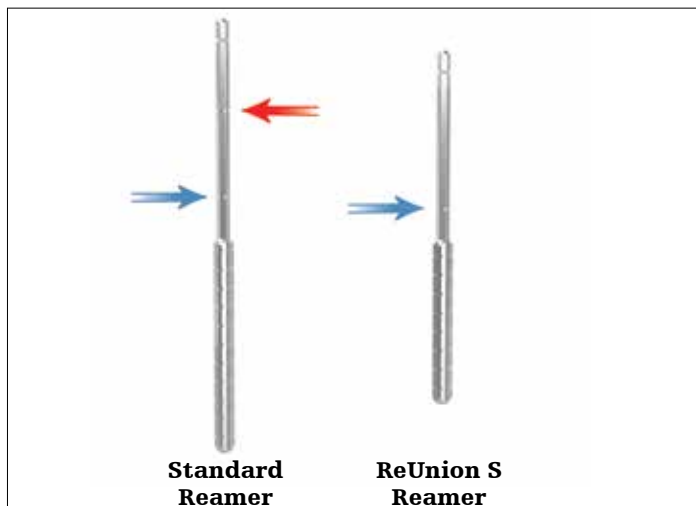

Figure 25

Retractors are placed beneath the rotator cuff tissue superiorly and medially to provide adequate exposure of the canal for reaming. A Darrach retractor along the posterior humerus can lever against the coracoid, exposing the entire humeral metaphysis. Reaming begins with bullet-tip fluted cylindrical reamers.

Reaming should be performed manually using the quick release ratcheting T-handle and be progressive in size (i.e. 7mm, 8mm, 9mm, etc) until friction is felt as the reamer contacts cortical bone.

When cortical contact is achieved, detach the ratcheting T-handle and leave the last reamer used within the humeral canal.

NOTICE

These engraved marks are only present on reamer sizes 8 and above.

The last reamer size used will match the distal size of the broach to be used.

When using reamer sizes 18-20 an extramedullary resection approach must be utilized.

WARNING

The slotted mallet should not be utilized to strike the underside of the ratcheting T-handle for extraction or removal of the starter awl or cylindrical reamers.

When utilizing the IM resection guide for a press-fit stem or cemented stem, the reamers should be inserted to the first line above the cutting teeth (Figure 25, blue arrow).

If a ReUnion TSA long stem prosthesis is indicated, reaming depth is to the second line positioned near the top of the standard reamer shaft (Figure 25, red arrow).

NOTICE

For cemented stems with a cement restrictor and ReUnion TSA long stems, additional reaming is necessary after humeral head resection.

Humeral head resection and canal reaming



Figure 26

Make sure that the clamp tower can be assembled correctly by aligning the engrave arrow on the clamp tower to the engraved arrow on the cylindrical reamer.

NOTICE

The starter awl and all of the cylindrical reamers have the "D" shaped cross section marked by a large arrow, to mate with the large arrow marked IM resection guide's clamp tower.



Figure 27

Once aligned, depress the cantilever arm of the clamp tower and slide it down over the shaft of the starter awl until the clamp tower comes in contact with the humeral head (Figure 27).

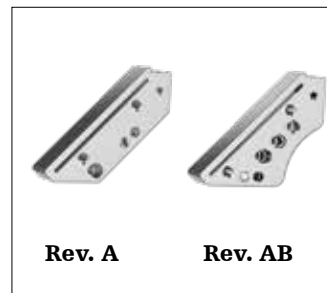

Figure 27a

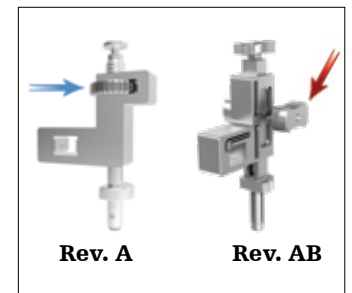

Figure 27b

There are two existing resection guide blocks available, Rev. A and Rev. AB (Figure 27a). Both revisions will assemble in the same fashion to either IM resection guide version (Figure 27b) as detailed below.

Assemble the IM resection guide to the resection guide block. For Rev A, depress the superior plunger on the resection guide (Figure 28, inset) attach the resection guide block (Figure 28, Left), and release superior plunger. For Rev AB, assemble the resection guide block to the resection guide and turn the superior knob clockwise to lock the resection guide block in place (Figure 28, Right).

Make sure to correctly orient the IM resection guide to the correct side of the resection guide block as noted by the L or R markings on each of the instruments.

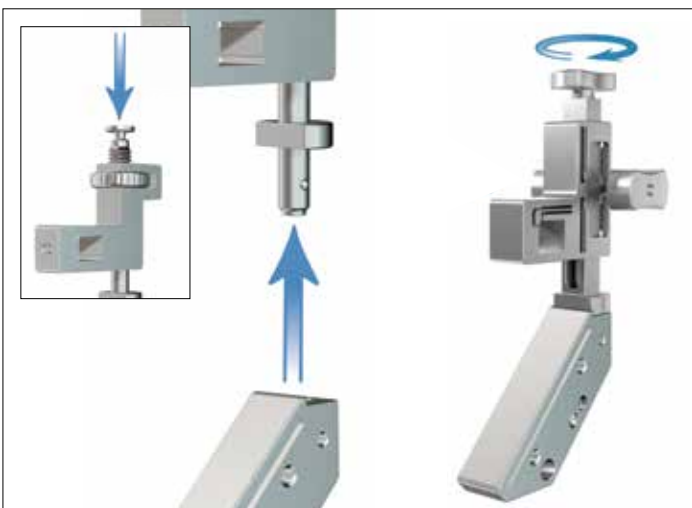

Figure 28

Humeral head resection and canal reaming

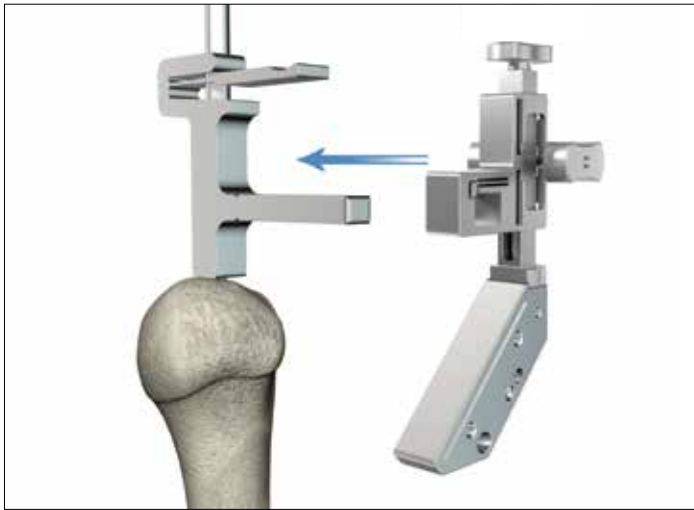

Figure 29

Slide the IM resection guide and resection block assembly onto the clamp tower making sure the orientation is correct by visualizing the markings L or R (Figure 29).

The cantilever arm should be used for macro height adjustments. For micro height adjustments, the resection guide can be adjusted:

Rev A – Turn the fine adjustment wheel located just below the superior plunger (Figure 27b, Blue arrow)

Rev AB – Turn the fine adjustment knob located on the side of the resection guide, just below the superior knob (Figure 27b, Red arrow).

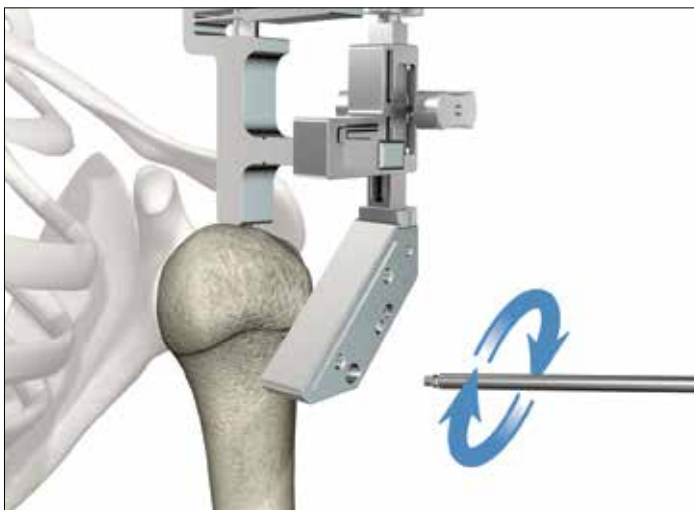

Figure 30

Prior to headless pin insertion, ensure the arm is properly retroverted. Thread the version rod into the resection guide block at the desired retroversion to either 20°, 30° or 40° of retroversion (Figure 30).

NOTICE

Resection block Rev. A accommodates 30° of retroversion while Resection block Rev. AB accommodates either 20°, 30° or 40° of retroversion.

WARNING

The version rod is not intended to be a load bearing instrument.
Do not use the version rod to rotate the assembly or the awl/reamer.

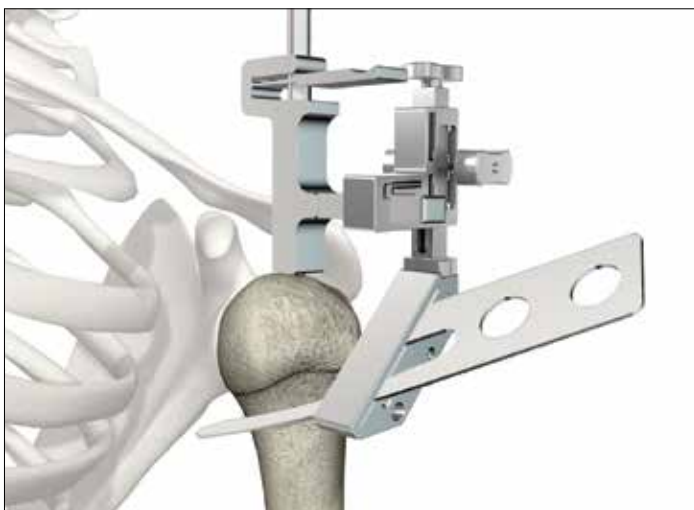

Figure 31

It is recommended that the resection level be confirmed by sliding the bladerunner instrument through the resection guide block captured cutting slot and assessing the planned thickness and plane of resection (Figure 31).



Humeral head resection and canal reaming

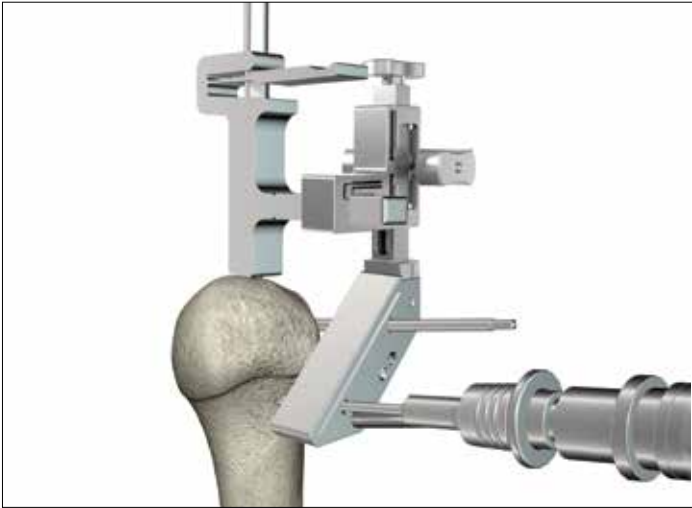

Figure 32

NOTICE

The following instructions for securing the humeral resection block are only applicable when using reamer sizes 7-17. When using reamer sizes 18-20 it is recommended to use an extramedullary resection approach. If an intramedullary resection approach is required for reamer sizes 18-20 see the Appendix.

When the level of the humeral head resection is confirmed, pin the humeral resection guide block to the humerus using the provided headless pins.

Using the pin driver attachment or pin collet, drive two (2) straight pins, perpendicular to the resection guide block, into place (Figure 32).

With the humeral resection guide block pinned to the humerus with two (2) straight pins, remove the version rod. Prepare to detach the resection guide from the resection guide block:

Rev A – Depress the plunger on the IM Resection Guide assembly (Fig. 33a, Blue Arrow)

Rev AB – Turn the superior knob on the resection guide counter-clockwise until it stops (Fig. 33b, Blue Arrow)

Pull the IM Resection Guide Assembly and Fluted Cylindrical Reamer from the humeral canal in one piece, leaving only the cutting block behind (Fig. 33a, 33b, Red Arrow).

With only the humeral cutting block in place drive the third and final cross pin into the humeral cutting block to secure it in place prior to starting the humeral resection.

NOTICE

Hole marked as "X" is for insertion of the cross-pin.

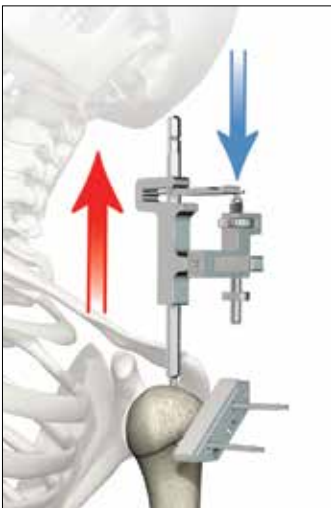

Figure 33a



Figure 33b

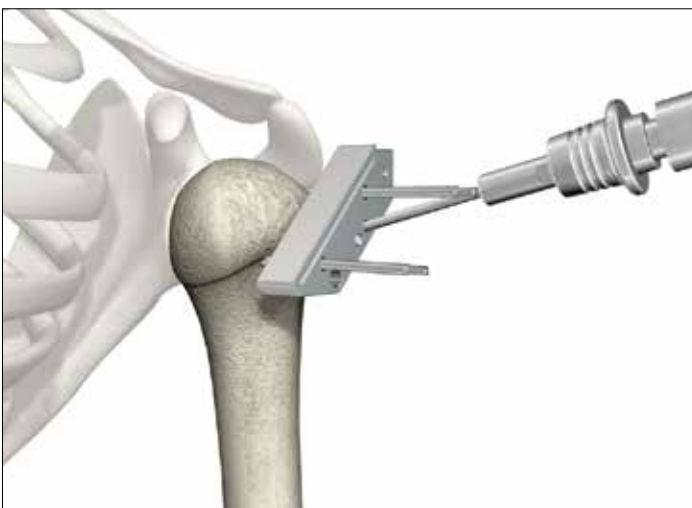

Figure 34

Humeral head resection and canal reaming

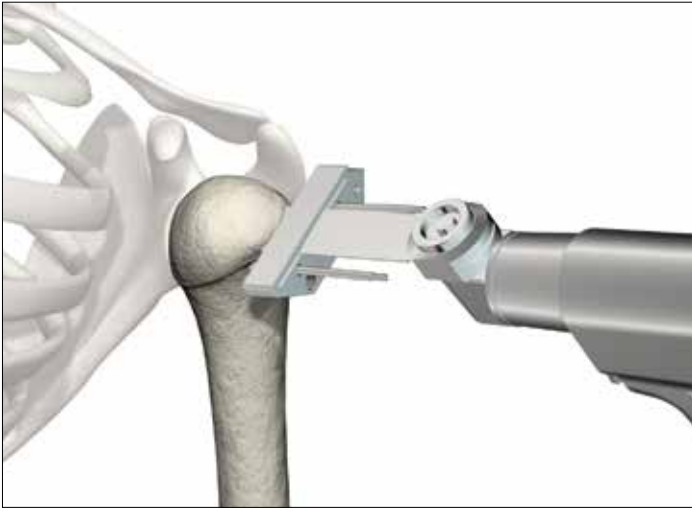

Figure 35

With all three (3) headless pins in place, position the saw blade through the cutting slot for a captured cut.

NOTICE

A sagittal sawblade that has a width of 1/2" (12mm) or less is desirable.

Ensure that the blade is oscillating prior to coming in contact with bone.

Inspect sawblade for any defects prior to utilization.

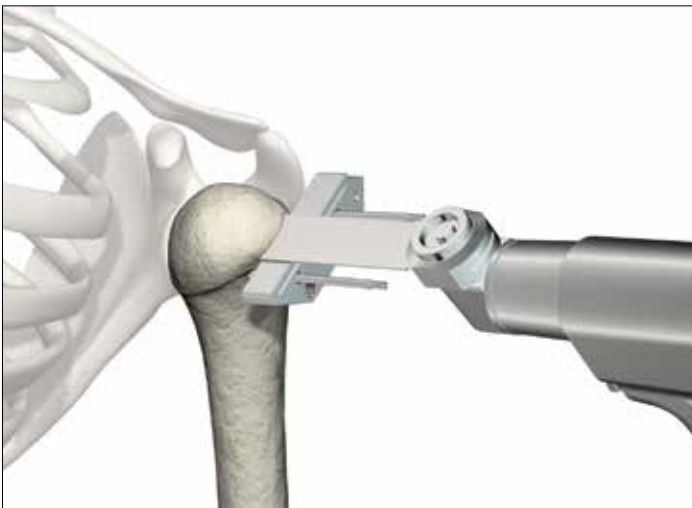

Figure 36

Alternatively, place the saw blade directly on the resection block for an open cut.

WARNING

To avoid cutting through the posterior capsule, stop the oscillating blade just short of the capsule and complete the cut with an osteotome.



Figure 37

Once the cut has been completed, remove the headless pins using the headless pin removal tool and then the cutting block.

CAUTION

Care should be taken to protect the biceps tendon and rotator cuff insertion with a small Hohman or Crego retractor during head resection.

The correct cut should remove all of the articular surfaces at the margins of the capsule and rotator cuff attachments superior and posterior. Those soft tissue attachments must be preserved.

Humeral head resection and canal reaming

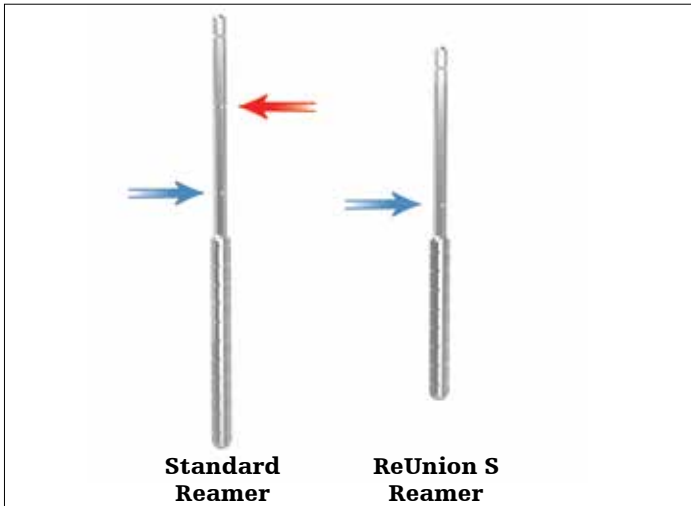

Figure 38

As previously mentioned, additional reaming is necessary for cemented stems with a cement restrictor and ReUnion TSA long stems. The following steps are performed once the humeral head has been resected.

If a cemented stem with a cement restrictor is going to be utilized, the reamer should be inserted to the depth of the first line above the cutting teeth (Figure 38, blue arrow).

If a ReUnion TSA long stem prosthesis is indicated, reaming depth is to the second line positioned near the top of the standard reamer shaft (Figure 38, red arrow).

Humeral head resection and canal reaming (superior-lateral approach)

NOTICE

Ensure that standard canal reamers are only used with standard stems and ReUnion S canal reamers are only used with ReUnion S stems.

Assemble the 6mm starter awl and the ratcheting T-handle [Figure 39] and place the tip of the starter awl in line with the long axis of the humerus to bore a pilot hole through the humeral head along the long axis of the humeral shaft.

Placement should be somewhat lateral and just posterior to the bicipital groove. This will allow for appropriate neutral position within the canal.

The entry point is made posterior to the bicipital groove, relatively lateral on the head's articular surface and just medial to the rotator cuff attachment site. Using a mallet, lightly tap the awl into the canal.

The starter awl can be impacted through the humeral head starting position using the mallet to impact on the metal pad of the T-handle.

NOTICE

The T-handle can be placed into three different positions marked on the collar near the silicone handle. These positions are marked as "R" for REVERSE, "L" for LOCKED, and "F" for FORWARD. The user should align the white arrow marker with the appropriate directional setting during use.



Figure 39

Humeral head resection and canal reaming



Figure 40

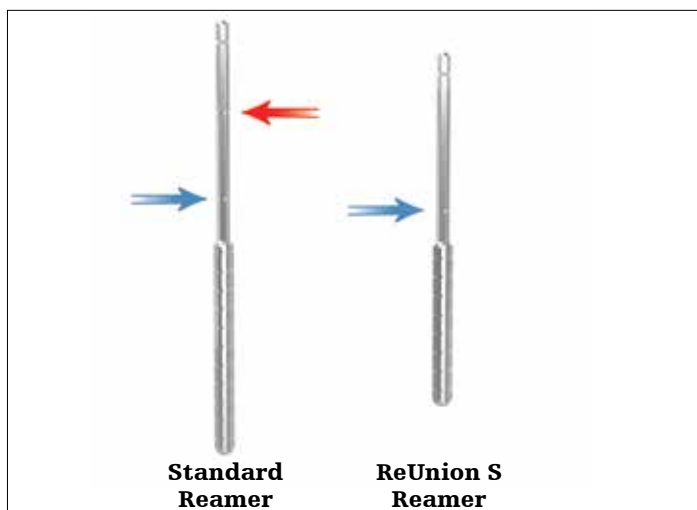

Figure 41

Manually insert the starter awl until the larger diameter portion (positive stop) above the cutting teeth is located just above the humeral head.

⚠ CAUTION

It is important not to let the coracoid / conjoined tendon crowd the posterior humeral metaphysis and force your canal entry too anterior. The IM entry point should be slightly (2mm) posterior.

Once the entry point has been made through the humeral canal, remove the 6mm starter awl, and begin to ream the humeral canal with the fluted cylindrical humeral reamers.

Retractors are placed beneath the rotator cuff tissue superiorly and medially to provide adequate exposure of the canal for reaming. A Darrach retractor along the posterior humerus can lever against the coracoid, exposing the entire humeral metaphysis. Reaming begins with bullet-tip fluted cylindrical humeral reamers.

Reaming should be performed manually using the quick release ratcheting T-handle and be progressive in size (i.e. 7mm, 8mm, 9mm, etc) until friction is felt as the reamer contacts cortical bone.

When cortical contact is achieved, detach the ratcheting T-handle and leave the last reamer used within the humeral canal.

⚠ WARNING

The slotted mallet should not be utilized to strike the underside of the ratcheting T-handle for extraction or removal of the starter awl or cylindrical reamers.

NOTICE

The last reamer size used will match the distal size of the broach to be used.

When using reamer sizes 18-20 an extramedullary resection approach must be utilized.

When utilizing the IM resection guide for a press-fit stem or cemented stem, the reamers should be inserted to the first line above the cutting teeth (Figure 41, blue arrow).

If a ReUnion TSA long stem prosthesis is indicated, reaming depth is to the second line positioned near the top of the standard reamer shaft (Figure 41, red arrow).

NOTICE

For cemented stems with a cement restrictor and ReUnion TSA long stems additional reaming is necessary after humeral head resection.

Humeral head resection and canal reaming



Figure 42

Make sure that the clamp tower can be assembled correctly by aligning the engraved arrow on the clamp tower to the engraved arrow on the cylindrical reamer [Figure 42].

NOTICE

The starter awl and all of the cylindrical reamers have the "D" shape cross section marked by a large arrow, to mate with the large arrow marked IM resection guide's clamp tower [Figure 42].

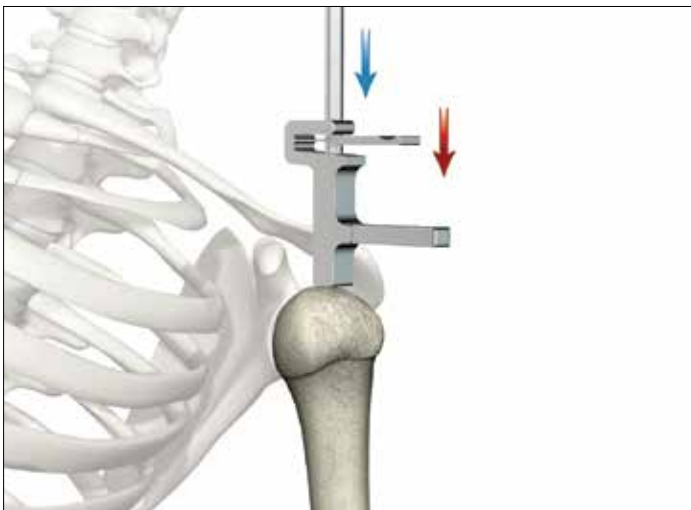

Figure 43

Once aligned, depress the cantilever arm of the clamp tower (red arrow) and slide it down over the shaft of the starter awl (blue arrow) until the clamp tower comes in contact with the humeral head [Figure 43].

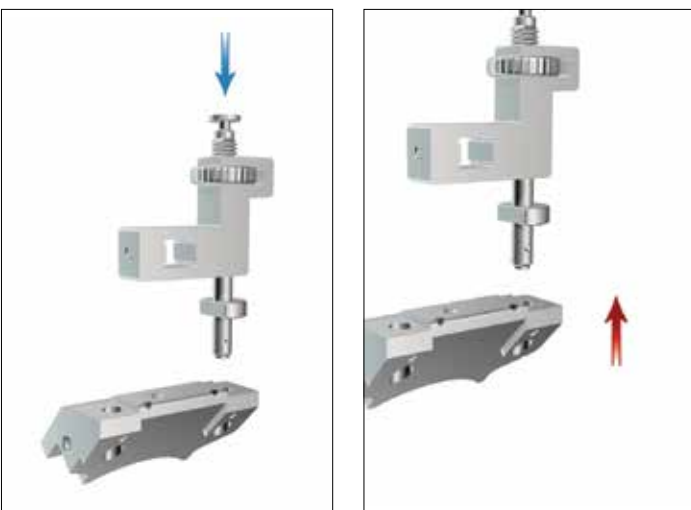

Figure 44

Assemble the IM resection guide to the superior resection guide block by depressing the plunger on the IM resection guide (blue arrow) and attaching the superior resection guide block (red arrow) [Figure 44].

Make sure to correctly orient the IM resection guide to the desired side of the superior resection guide block. L or R markings on the IM guide should match the L or R markings on the resection guide block.

Humeral head resection and canal reaming



Figure 45

Slide the IM resection guide and superior resection block assembly onto the clamp tower [Figure 45].

The cantilever arm should be used for macro height adjustments, while the fine adjustment wheel located just below the superior plunger should be utilized for micro height adjustments.

Ensure the guide is in proper retroversion by using the version rod and aligning the forearm in the desired retroversion.

NOTICE

Threaded version rod holes are at 30° of retroversion.

WARNING

The version rod is not intended to be a load bearing instrument.

Do not use the version rod like a breaker bar to attempt to rotate the IM resection assembly.

NOTICE

Although marked with L/R markings for left and right orientation to each other, the IM resection guide and superior resection block assembly can be used in either orientation for left or right shoulders, regardless of markings.



Figure 46

It is recommended that the resection level be confirmed by sliding the bladerunner instrument through the cutting block's captured cutting slot and assessing the planned thickness and plane of resection [Figure 46].

When the level of the humeral head resection is confirmed, pin the superior resection guide block to the humerus using the provided headless pins.

Using the headless pin driver attachment or pin collet, drive two (2) straight pins into the resection guide block.

With the superior humeral resection guide block pinned to the humerus with two (2) straight pins, depress the plunger (blue arrow) then pull the resection guide assembly and starter awl/reamer from the IM canal in one piece (red arrow), leaving only the superior resection block behind.



Figure 47

Humeral head resection and canal reaming



Figure 48

With only the superior humeral resection block in place, drive the third and final cross pin into the superior humeral resection block to secure it in place prior to starting the humeral resection.

Place the saw blade through the captured cutting slot and begin to make the superior-lateral humeral head cut.

Once the cut has been completed, remove the headless pins using the headless pin removal tool and then the superior humeral resection block.

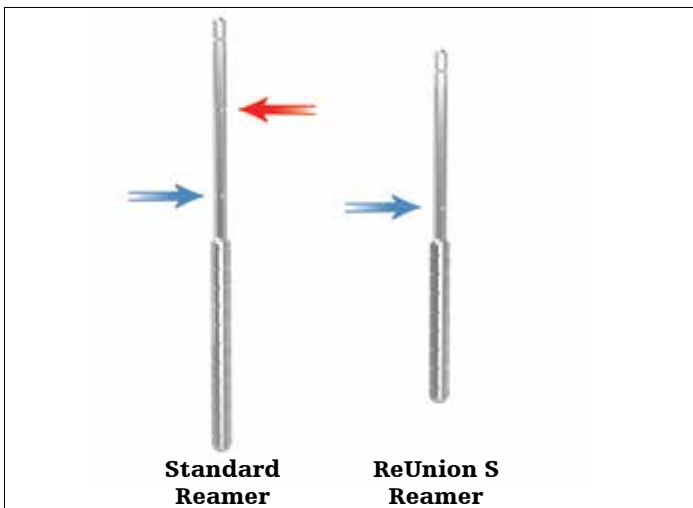

Figure 49

As previously mentioned, additional reaming is necessary for cemented stems with a cement restrictor and ReUnion TSA long stems. The following steps are performed once the humeral head has been resected.

If a cemented stem with a cement restrictor is going to be utilized, the reamer should be inserted to the depth of the first line above the cutting teeth (Figure 49, blue arrow).

If a ReUnion TSA long stem prosthesis is indicated, reaming depth is to the second line positioned near the top of the standard reamer shaft (Figure 49, red arrow).

Humeral preparation

Humeral preparation

Broaching the humerus

Upon completion of humeral canal reaming, select a humeral broach that is at least 4mm smaller than the size of the last reamer used.

⚠ WARNING

Do not use the broach handle/stem inserter for removal of a well fixed or cemented humeral stem.

NOTICE

Ensure that standard broaches are only used with standard stems and ReUnion S broaches are only used with ReUnion S stems.

Catalog #		Reamed diameter	Final broach size	Press-fit stem size
Standard stems	ReUnion S stems			
5569-P-2007	5567-P-3007	7 mm	7 mm	7 mm
5569-P-2008	5567-P-3008	8 mm	8 mm	8 mm
5569-P-2009	5567-P-3009	9 mm	9 mm	9 mm
5569-P-2010	5567-P-3010	10 mm	10 mm	10 mm
5569-P-2011	5567-P-3011	11 mm	11 mm	11 mm
5569-P-2012	5567-P-3012	12 mm	12 mm	12 mm
5569-P-2013	5567-P-3013	13 mm	13 mm	13 mm
5569-P-2014	5567-P-3014	14 mm	14 mm	14 mm
5569-P-2015	5567-P-3015	15 mm	15 mm	15 mm
5569-P-2016	5567-P-3016	16 mm	16 mm	16 mm
5569-P-2017	5567-P-3017	17 mm	17 mm	17 mm
	5567-P-3018	18 mm	18 mm	18 mm
	5567-P-3019	19 mm	19 mm	19 mm
	5567-P-3020	20 mm	20 mm	20 mm



Standard Broach



ReUnion S Broach

Catalog #		Reamed diameter	Final broach size	Cemented stem size
Standard stems	ReUnion S stems			
5569-C-2006	5567-C-3006	8 mm	8 mm	6 mm
5569-C-2106L		8 mm	8 mm	6 mm
5569-C-2007	5567-C-3007	9 mm	9 mm	7 mm
5569-C-2008	5567-C-3008	10 mm	10 mm	8 mm
5569-C-2108L		10 mm	10 mm	8 mm
5569-C-2009	5567-C-3009	11 mm	11 mm	9 mm
5569-C-2010	5567-C-3010	12 mm	12 mm	10 mm
5569-C-2110L		12 mm	12 mm	10 mm
5569-C-2011	5567-C-3011	13 mm	13 mm	11 mm
5569-C-2012	5567-C-3012	14 mm	14 mm	12 mm
5569-C-2112L		14 mm	14 mm	12 mm
5569-C-2013	5567-C-3013	15 mm	15 mm	13 mm
5569-C-2014	5567-C-3014	16 mm	16 mm	14 mm
5569-C-2015	5567-C-3015	17 mm	17 mm	15 mm
	5567-C-3016	18 mm	18 mm	16 mm
	5567-C-3017	19 mm	19 mm	17 mm
	5567-C-3018	20 mm	20 mm	18 mm

Humeral preparation



Figure 50

Ensure the broach handle/stem inserter is in proper retroversion by threading in the version rod and aligning the patient's forearm with the version rod.

WARNING

The version rod is not intended to be a load bearing instrument.

Do not use the version rod like a breaker bar and attempt to rotate the broach handle to adjust the version.

The version rod must be removed prior to striking the underside of the impaction pad to avoid damaging the version rod during evaluation.

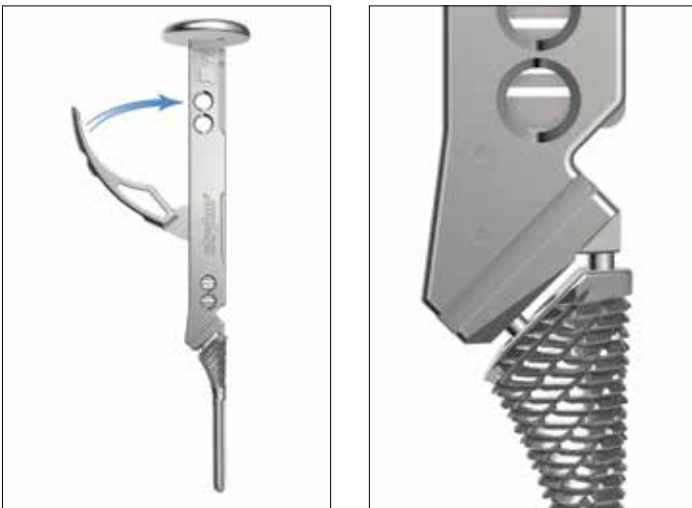

Figure 51

Attach the broach to the broach handle/stem inserter by making sure the locking pin is engaged and the broach is drawn onto the alignment pin while closing the handle.



Figure 52

The broach and broach handle/stem inserter will lock together via the handle on the medial side of the broach handle. It can be disengaged by releasing the same handle.

NOTICE

Prior to impaction, ensure that handle is closed and firmly grasped during mallet blows.

Humeral preparation



Figure 53

Impact the broach along the long axis of the humerus. The broach is fully seated when the superior face of the broach is sitting flush to the resection surface of the humerus.

Sequentially broach the humeral canal until the last humeral broach size used matches the diameter of the final cylindrical reamer used.

CAUTION

Avoid excessive impaction of a well fixed broach as this may lead to fracture of the humerus.

WARNING

Do not use a humeral broach larger than the last cylindrical reamer used without first reaming up to the appropriate diameter if increased proximal fit is desired.

NOTICE

When removing the humeral broaches using the broach handle, make sure that upward mallet blows are placed on the strike pad.

The final broach utilized should be left in place as a trial and modular head and/or neck trials can be evaluated.



Figure 54

Humeral preparation

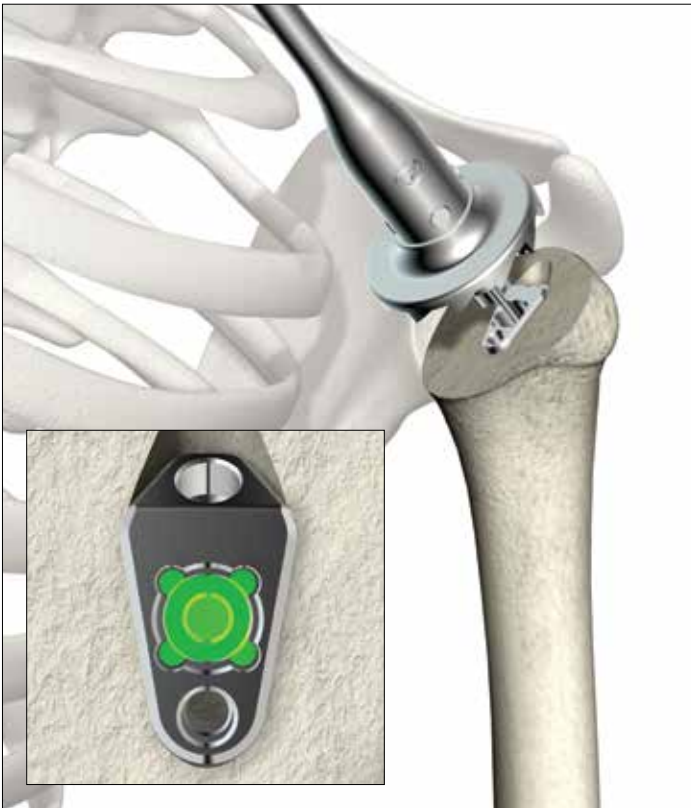

Figure 55

Osteotomy evaluation and calcar planing

Assess the planer's relationship to the resected plane. If the angle diverges, then the calcar planer shall be utilized to finalize the plane, providing an optimum resection for the fixed head configuration (Figure 55).

If required, select the appropriate size calcar planer (see table below) to refine the resected surface.

Insert the calcar planer into the ratcheting T-handle and then insert the calcar planer's guide post into the mating surface on the humeral broach (Figure 55, inset).

Humeral head size	Calcar planer
40, 44, 48	Small
48, 52	Medium
52, 56	Large

WARNING

Do not use the calcar planers under power. They are intended for manual use only.

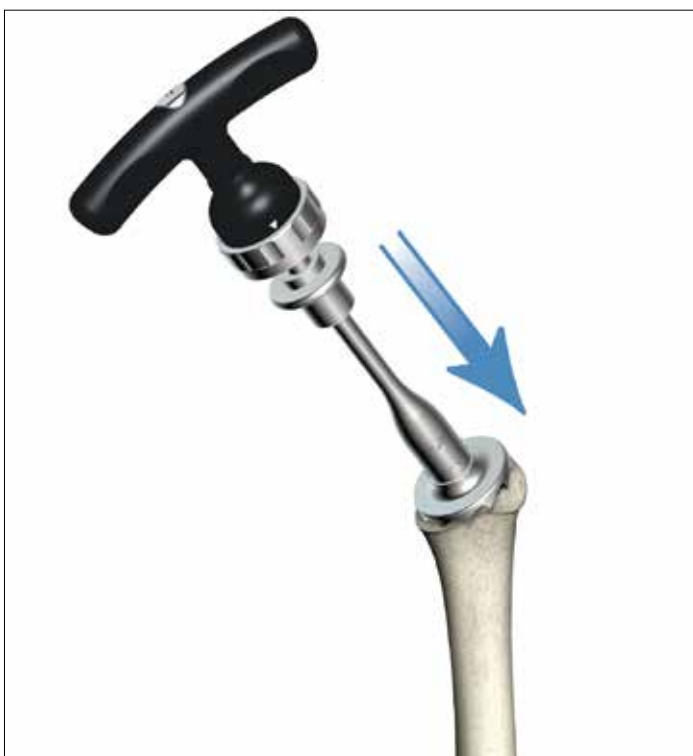

Figure 56

The angle of the calcar planer, when correctly placed into the broach, will be perpendicular to the standard neck angle of 135°.

Apply axial pressure onto the ratcheting T-handle and carefully refine the resected humeral surface.

NOTICE

To cut, depress the spring loaded shaft until a positive stop is reached.

Humeral preparation

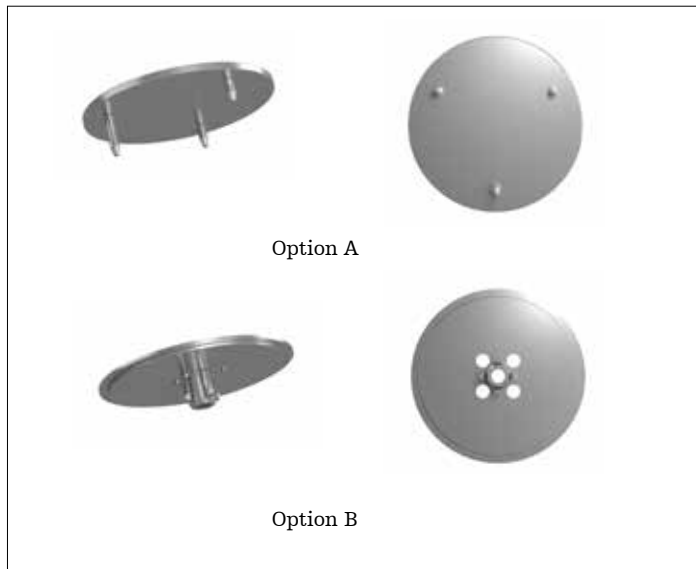

Figure 57

Humeral protector plate

There are two existing Humeral protector plates available, Option A and Option B (Figure 57). Option A is designed with teeth that will press into the humeral bone, while Option B is designed to interface directly with the broach.

Upon completion of the humeral head resection and calcar planing, if using Option A place the appropriate sized humeral resection protector plate onto the resected surface. If using Option B, insert the post of the appropriate sized humeral resection protector plate into the mating surface of the humeral broach (Figure 58, inset).

This will protect the humerus during retraction, for glenoid preparation.



Figure 58

NOTICE

For Option A the long pin of the calcar plate should be utilized in rotating and positioning the plate on the resected surface.

The humeral protector plate may not fully seat if the broach is not fully seated.

WARNING

Make sure not to damage the cortical bone around the perimeter of the resection of the humerus.

Glenoid

preparation

Glenoid preparation

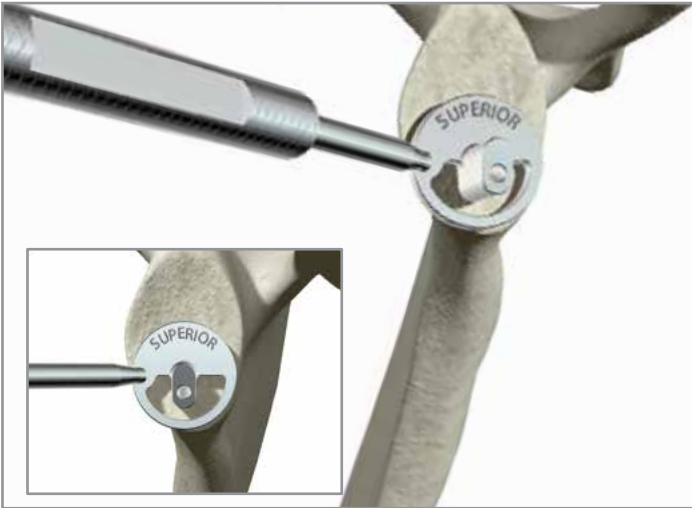

Figure 59

Placement of the pilot wire

Place the glenoid baseplate centering guide onto the face of the glenoid so that the inferior most portion of guide is aligned with the inferior most portion of the glenoid itself and the “SUPERIOR” marking can easily be seen superiorly [Figure 59 inset].

Tech tip:

The outer diameter of the glenoid baseplate centering guide matches the outer diameter (28mm) of the glenoid baseplate implant. A 10° inferior tilt has been built into the glenoid baseplate centering guide.

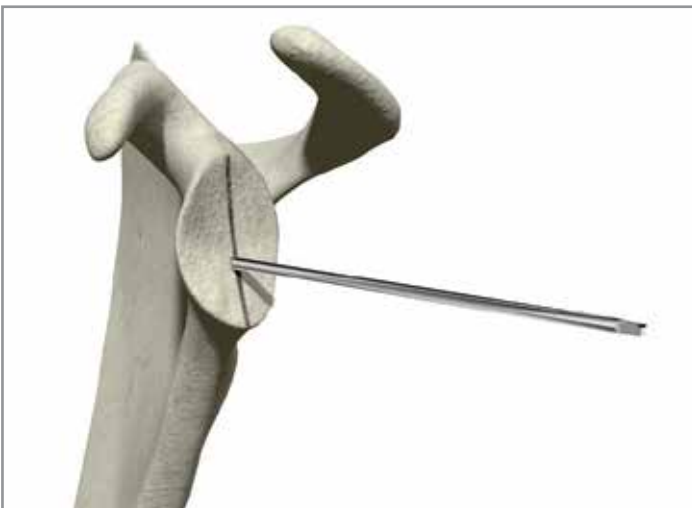

Figure 60

If glenoid has a severe deformity or if the exposure and/or surrounding tissue does not allow for intended placement of the guide then use of the centering guide may not yield an optimal placement of the guide wire. In this case a freehand insertion of the guide wire is acceptable.

To estimate the guide wire location, draw a line along the SI axis of the glenoid. Insert the guide wire on the SI axis approximately 14 mm superior to the inferior border of the glenoid (Figure 60). Angle guide wire along SI axis to establish the desired inclination. 10 degrees of inferior inclination is recommended.



Figure 61

Insert the calibrated 3.2mm pilot wire into the glenoid using the included pin driver or a pin collet at the desired position and depth, ensuring the pin engages the medial cortical wall (Figure 61).

Ideally, the 3.2mm pilot wire should be placed into the best possible bone stock, keeping in mind that eccentric glenospheres are included in the ReUnion RSA System and can be positioned in any direction [See Table Below].

Glenosphere	32	36	40
Lateral offset (mm)	+2, +6	+2, +6	+2, +6
Eccentricity (mm)	0	0, +2	0, +2, +4

Glenoid preparation

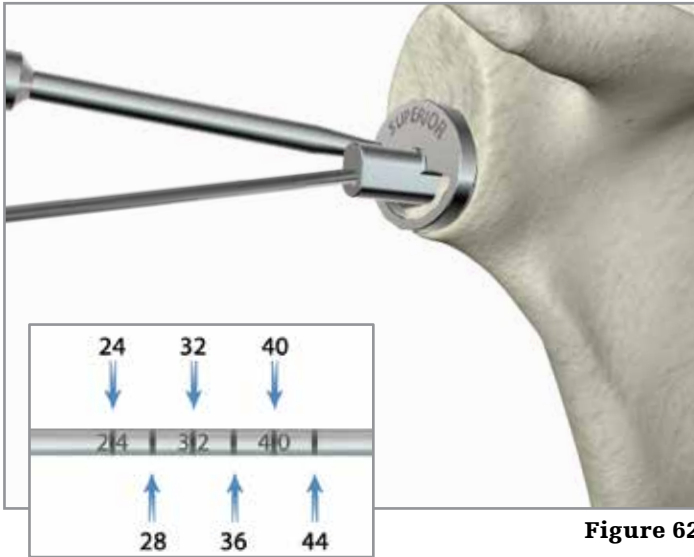

Figure 62

WARNING

The calibrated 3.2mm pilot wire is a SINGLE USE ONLY instrument.

Measuring depth of pilot wire

The depth of the pilot wire can be measured by aligning the calibrated markings on the 3.2mm pilot wire [Figure 62, inset] with the flat surface of the glenoid baseplate centering guide [Figure 62].

Tech tip:

The 3.2mm pilot wire has calibrated markings that correspond to the lengths of center screws available in the system (24, 28, 32, 36, 40, and 44mm).

If the centering guide is not used, do not measure the pilot wire depth using the calibrated markings. The depth gauge must be used for central screw measurement.

Glenoid preparation

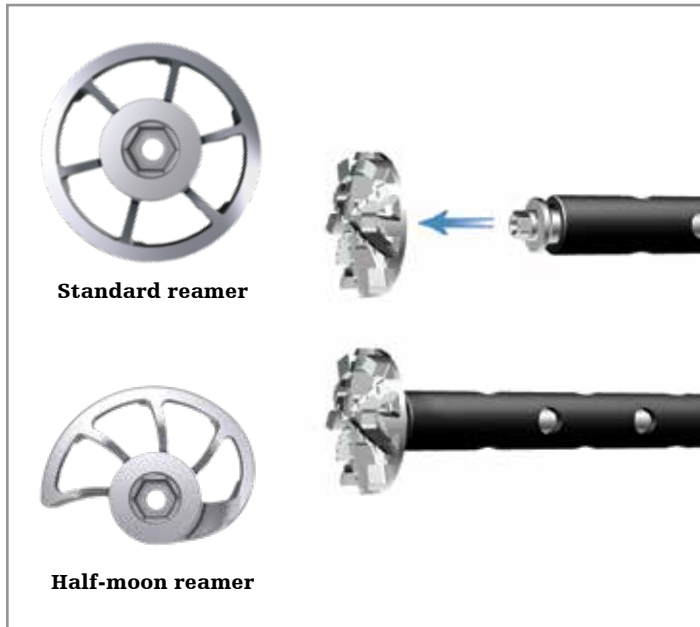

Figure 63

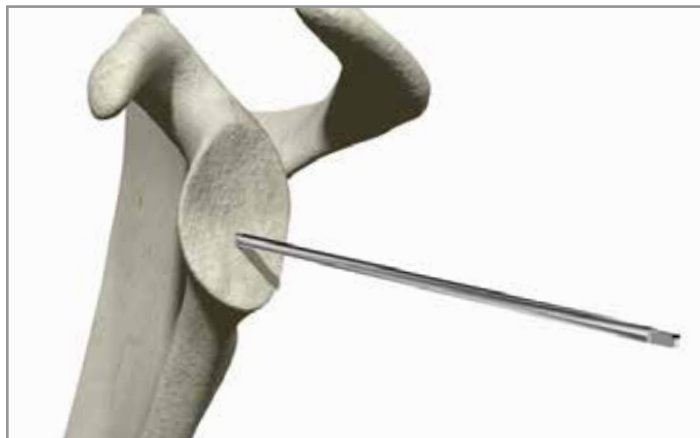

Figure 64

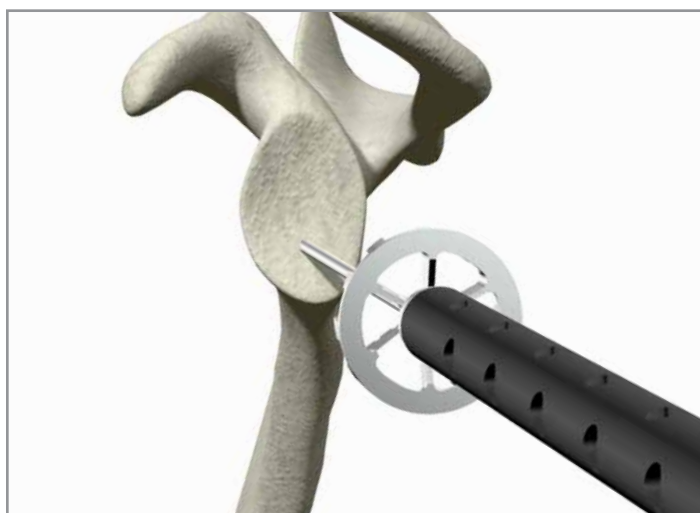

Figure 65

Reaming and planing the glenoid

Glenoid reamer/planars are available in three styles: standard quick-connect, standard magnetic & half-moon magnetic. When glenoid access is particularly challenging, half-moon reamer/planars provide a lower-profile option to facilitate insertion.

Select the appropriately sized Standard or Half-moon reamer/planar and assemble it to the straight reamer driver via the hex feature (both standard and low-profile reamer drivers are available).

Glenoid reamer/planar	32	36	40
Diameter (mm)	32	36	40

NOTICE

All of the glenoid reamer/planars have the same radius of curvature; as long as the soft tissue permits, any of the reamer/planars can be used to prepare the glenoid implants.

Tech tip:

If the user is uncertain at this step which glenosphere size will be utilized, it is recommended that the largest size glenoid reamer/planar be used that the patient's anatomy will accommodate.

NOTICE

The glenoid reamer/planars are designed to ream the glenoid face and plane the outer edge to receive the glenoid baseplate and glenosphere implants.

⚠ CAUTION

During reaming, make sure to use the power instruments in "REAM" mode or be sure to utilize reamer specific attachments for proper RPM and torque settings.

Standard Glenoid Reamer/Planars

With the calibrated 3.2mm pilot wire in place, position the standard glenoid reamer/planar over the top of the 3.2mm pilot wire and begin to ream the glenoid face utilizing a pulsing method [Figure 65].

⚠ CAUTION

To ensure accuracy in reaming, apply power prior to the reamer/planar making contact with the lateral surface of the glenoid.

Glenoid preparation



Figure 66

Half-moon Glenoid Reamer/Planars

Position the Half-moon Reamer/Planar over the top of the 3.2mm pilot wire. Orient the reamer so that the semi-circular portion containing the cutting teeth is facing away from the resected surface of the humeral head [Figure 66].

The reduced profile of the Half-moon reamer face will allow it to bypass the resected humeral head and be more easily inserted onto the glenoid face. Although the Half-moon reamers are equipped with a leading curved edge that will limit the impact made on retractors, care should be taken to ensure that retractors are not encroaching on the area to be reamed prior to any reaming being performed.

Begin to ream the glenoid face utilizing a pulsing method. Once reaming is initiated, the axis of the reamer driver should be held constant and any rocking movements should be avoided to prevent irregular or uneven surface preparation.

Care should be taken to monitor reaming and verify the desired bone removed during the process.

CAUTION

To ensure accuracy in reaming, apply power prior to the reamer/planar making contact with the lateral surface of the glenoid.

NOTICE

Ensure that the Cannulated Reamer Driver is fully seated within the magnetic hex attachment prior to reaming.

Glenoid preparation

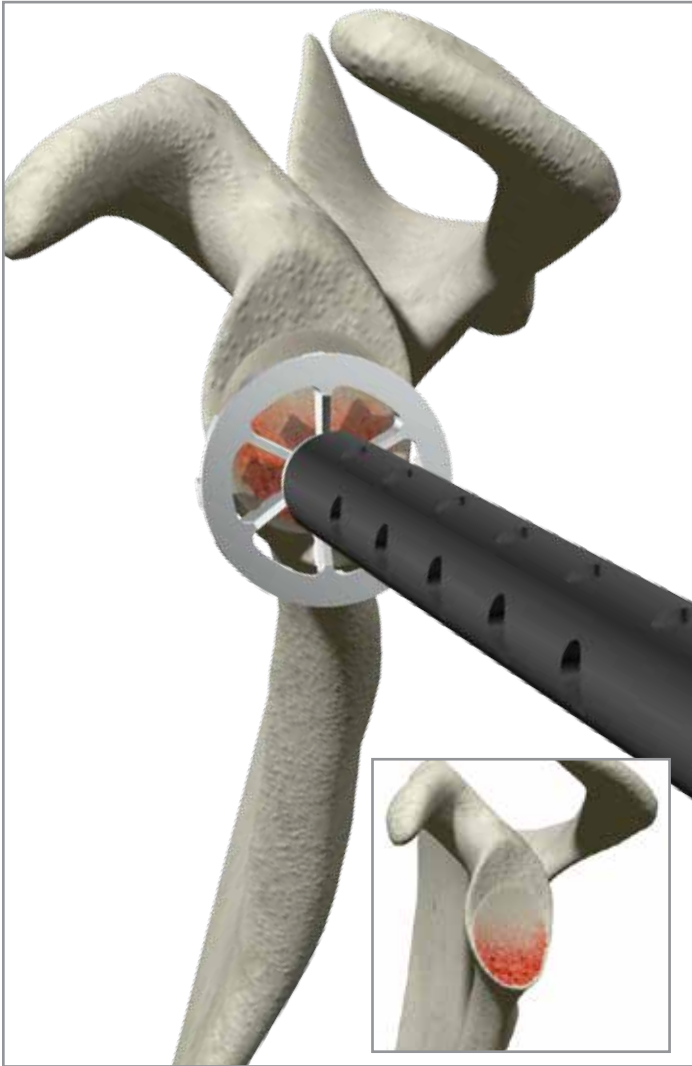

Figure 67

Pulse ream the glenoid to the desired level, ensuring that the medial geometry of the glenoid baseplate is completely reamed and contained inside the glenoid.

Tech tip:

Due to the included 10° inferior tilt in the glenoid baseplate centering guide, inferior reaming should be evident first. Superior reaming should then follow.

It is critical that the glenoid is adequately reamed to ensure complete seating of the glenoid baseplate. Ream to expose subchondral bone. Continue reaming to expose the subchondral bone on the inferior 50% of the prepared glenoid until bleeding bone is exposed and the entire circumference of the glenoid reamer/planar has made contact with the glenoid face.

⚠ CAUTION

There is no stop on the glenoid reamer, so continual attention to reaming depth is important. A full awareness of the patient's existing glenoid deformity/version prior to reaming is necessary to determine the amount of correction necessary for effective glenoid implantation.

⚠ CAUTION

Confirm there is adequate soft tissue clearance within the envelope of the reamer/planar to ensure glenosphere to baseplate taper lock.



Figure 68

If using an eccentric glenosphere [See table below], after standard glenoid reaming has been completed, be sure to use the included eccentric glenoid planar [Figure 68] to ensure the eccentric glenosphere can be properly seated to the glenoid baseplate without any interference from the backside of the glenosphere.

Prior to pilot wire removal, take note of and record the depth/length of the pilot wire as measured in a previous step.

Glenosphere	32	36	40
Lateral offset (mm)	+2, +6	+2, +6	+2, +6
Eccentricity (mm)	0	0, +2	0, +2, +4

Glenoid preparation

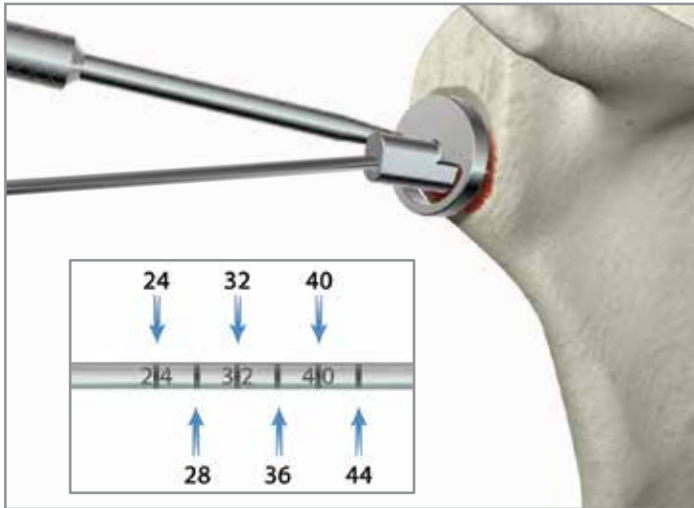

Figure 69

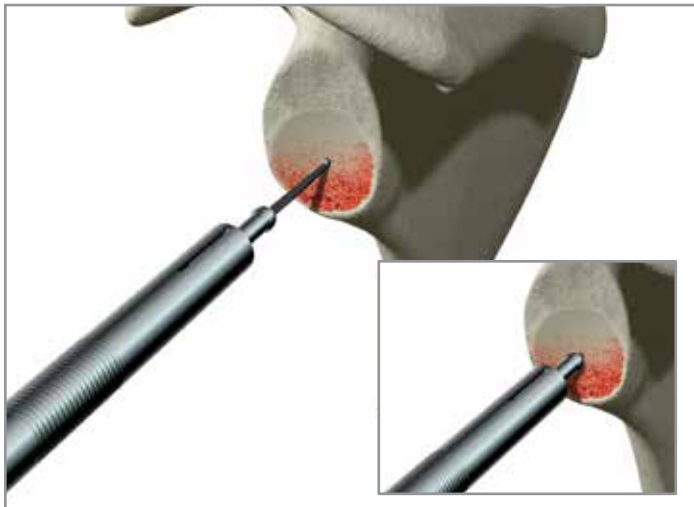

Figure 70

Measuring depth/length for center screw

Glenoid baseplate center screw length selection may be determined using the following methods:

1. With the calibrated 3.2mm pilot wire in place, read the corresponding depth marking on the pilot wire [Figure 69, inset] relative to the face of the glenoid baseplate centering guide [Figure 69].
2. If the 3.2mm pilot wire is removed, place the depth gauge into the prepared center screw hole and read the corresponding measurement from the depth gauge [Figure 70].

Remove the glenoid reamer/planar and/or glenoid planar and then remove the 3.2mm pilot wire using the pin collet or headless pin removal instrument.

When utilizing the depth gauge be sure to engage the far cortex with the hook of the depth gauge and place the tip of the instrument against the glenoid face before reading the measurement [Figure 70, inset].

CAUTION

During assembly of the depth gauge be sure not to pinch or impinge surgical glove between sub-assemblies.

When removing the depth gauge be sure to disengage the bone hook from the far cortex prior to removal of the instrument in order to prevent fractures and damage to the depth gauge's tip.

Tech tip:

It is important to prepare and select a center screw length that engages the far cortex to ensure optimal compression and fixation.

NOTICE

Center screw: Ø 6.5mm screw, lengths 24-44mm (4mm increments).

Tech tip:

Due to variations in patient morphology, depth measurements should be taken at multiple points to ensure the longest, most appropriate measurement is obtained.

Glenoid preparation

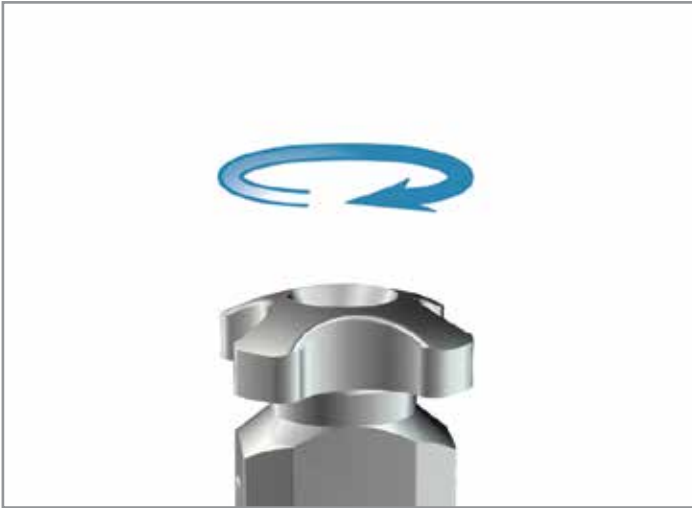

Figure 71

Baseplate and center screw placement

Insert the inner barrel of the baseplate holder into the outer handle.

While pressing down on the end of the inner barrel, tighten the knob at the end of the baseplate holder [Figure 71] to prepare the instrument to receive the glenoid baseplate implant.



Figure 72

With the inner barrel fully seated and tightened down into the outer barrel, squeeze the sides of the baseplate holder [Figure 72] and place the 28mm glenoid baseplate implant onto the retention pins by aligning them with two (2) of the peripheral screw holes. Release the sides of the baseplate holder to actively retain the glenoid baseplate.

The glenoid baseplate should now be securely fixed to the baseplate holder.

Glenoid preparation

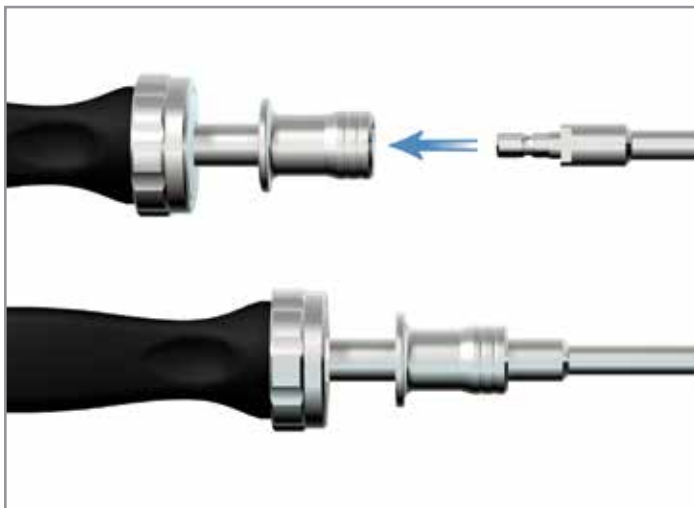

Figure 73

Assemble the center screw T25 driver to the 4-sided ratcheting handle [Figure 73].

Once assembled, the center screw T25 driver should be securely engaged into the 4-Sided handle and ready for use.

Tech tip:
The tip of the T25 driver is tapered slightly, providing self-retention of the screw to the driver.

Center screws may also be inserted by the use of power tools connected to the driver. Set power tool on “drill” or other low torque setting if available.

⚠ CAUTION

High torque or “ream” setting on power tool may result in bone damage.

The intent of center screw placement should be to compress the glenoid baseplate onto the face of the glenoid and achieve a bi-cortical lock.

NOTICE

It is important to prepare and select a center screw length that engages the far cortex to ensure optimal compression and fixation.

⚠ CAUTION

A correctly seated center screw will provide the best baseplate compression and fixation. This will also ensure the correct seating of the glenosphere to the glenoid baseplate.

Taking note of the measurements taken either with the calibrated guide pin or the depth gauge, select the appropriate length screw and verify its length with the screw identification tool built into the case/tray [Figure 74].

Place the selected center screw into the opening on the end of the baseplate holder and allow it to slide down into position on top of the glenoid baseplate [Figure 75].

Tech tip:
The selected center screw may also be loaded onto the center screw T25 driver prior to insertion into the baseplate holder.



Figure 74



Figure 75

Glenoid preparation

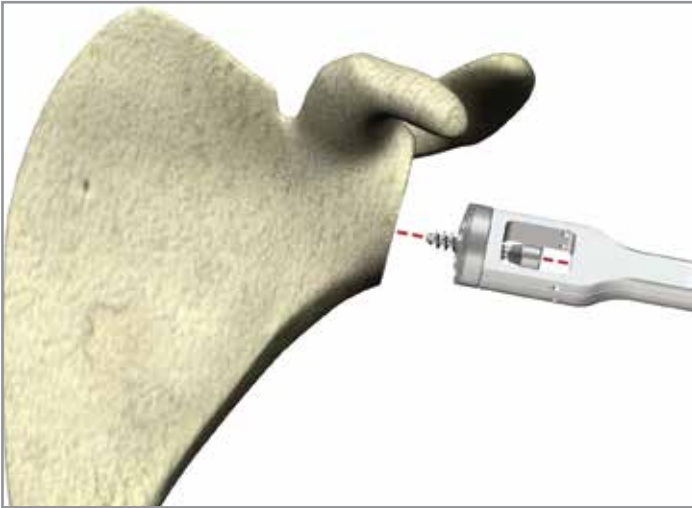

Figure 76

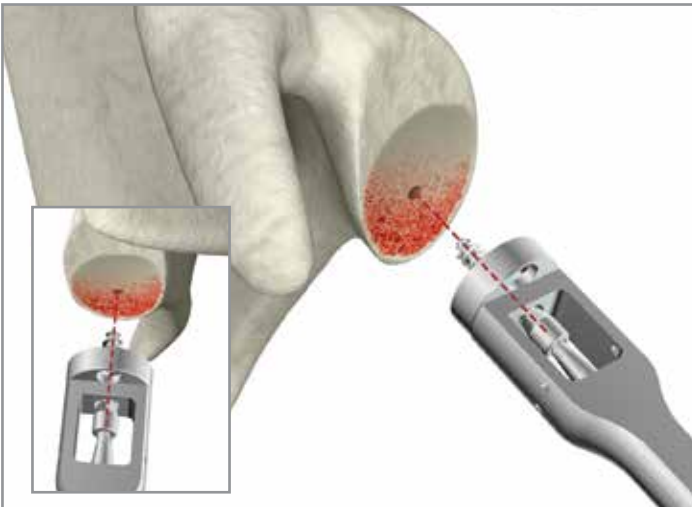

Figure 77

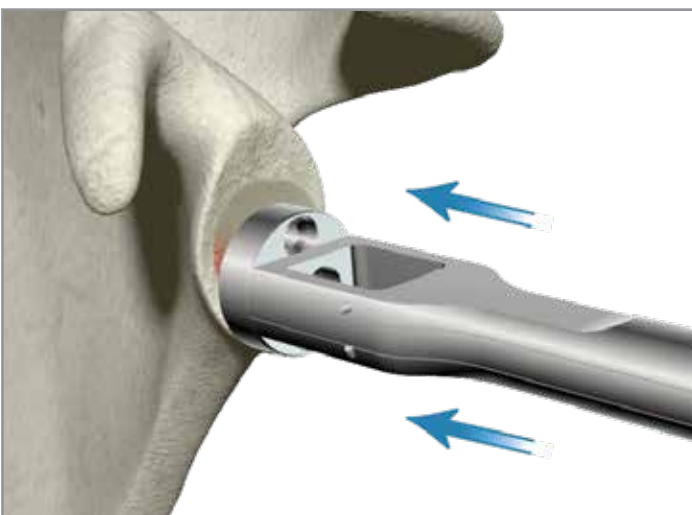

Figure 78

Align screw and handle along pilot wire trajectory per Figures 76 and 77.

Rotate the glenoid baseplate so that the inferior screw can be aimed toward the scapular neck. The superior screw should be aimed towards the base of the coracoid process superiorly (long axis of the glenoid bone) or the best available bone stock [Figure 77].

Insert the tip of the center screw into the hole that has been bored with the 3.2mm pilot wire.

Apply an axial force towards the face of the glenoid [Figure 78] while holding the baseplate holder firmly in place to prevent rotation of the glenoid baseplate.

With the center screw T25 driver securely attached to the center screw within the baseplate holder, begin to tighten down the center screw into the glenoid fossa.

⚠ WARNING

It is important to ensure the screw driver and screw are parallel with each other and the tip of the T25 driver is fully engaged in the screw head.

Deviation from this technique may lead to stripping of the driver and screw interface.

⚠ CAUTION

Ensure that the use of power is stopped before the threaded screw head contacts the baseplate to avoid damage to system components. Seat the screw with the manual 4-sided ratcheting handle.

When fully seated, the glenoid baseplate should sit flush with the glenoid face and the scapula should rotate slightly when attempting to tighten the center screw further onto the glenoid face.

Tech tip:

If the glenoid baseplate does not compress when using the selected screw, double check the measurement using the depth gauge and ensure that the far cortex can be captured using the appropriate length screw.

⚠ CAUTION

Once the center screw is fully seated in the baseplate, do not over-tighten the center screw.

Glenoid preparation



Figure 79

! WARNING

Once the center screw is locked into position DO NOT turn the glenoid baseplate handle to reposition or rotate the baseplate [Figure 79].

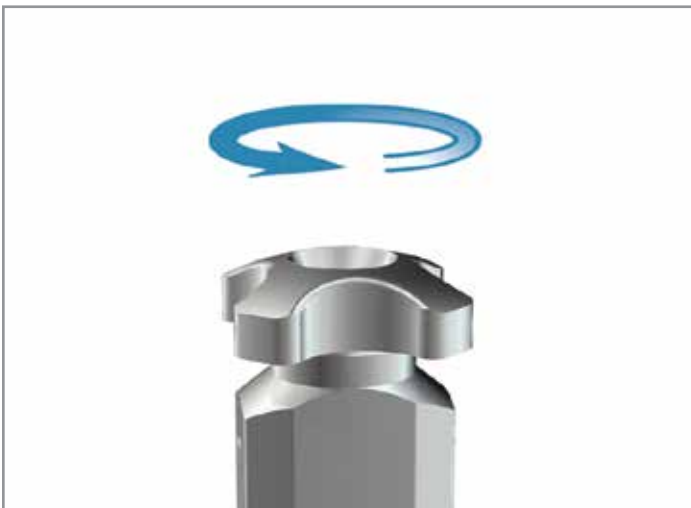

Figure 80

Remove the baseplate holder from the now locked glenoid baseplate by loosening the knob in a counter clockwise direction [Figure 80].



Figure 81

After the center screw has been properly locked into position on the glenoid baseplate, a visual inspection of the glenoid baseplate should be performed to confirm there are no gaps between the reamed surface and the glenoid baseplate.

NOTICE

After removing the baseplate holder, manually double check that the center screw is fully seated with the T25 driver.

Tech tip:
A correctly seated center screw will provide the best glenoid baseplate compression and fixation. This will also ensure the correct seating of the glenosphere to the glenoid baseplate.

Glenoid preparation



Figure 82

Preparation for peripheral screw placement

Inferior screw

Place the variable angle peripheral drill guide into the glenoid baseplate's inferior hole. The drill guide can be angled up to a maximum angle of $\pm 15^\circ$ but should always be engaged fully in the glenoid baseplate hole.

If possible, palpate the scapular neck and aim into the best possible bone, as close to the lateral border of the scapula as permitted.

NOTICE

The locking peripheral screws are designed to allow a maximum angulation of up to $\pm 15^\circ$ for optimal screw placement.

Peripheral screws: \varnothing 4.5mm screw, lengths 16-52mm (4mm increments).

Tech tip:

A separate fixed angled drill guide is included and can be utilized to place peripheral screws in a perpendicular configuration to the glenoid baseplate.

While firmly holding the peripheral drill guide against the glenoid baseplate, begin drilling through the subchondral bone to the desired optimal depth using the 3.1mm drill bit (Figure 83).

Tech tip:

Axial pressure should be maintained on the drill guide throughout the entire drilling process to ensure proper seating of the drill guide to the baseplate.

Redirect and re-drill as needed to achieve optimal peripheral screw trajectory and bone purchase.

CAUTION

Care must be taken during the drilling process in order to preserve as much bone as possible for screw purchase.



Figure 83

Glenoid preparation



Figure 84

Once the far cortex has been perforated take note of the depth by aligning the laser marked ring on the drill bit with the markings on the face of the guide [Figure 84].

The depth gauge can also be utilized to verify peripheral screw length by placing the depth gauge directly into and flush against the glenoid baseplate and engaging the far cortex with the depth gauge's hook.

⚠ CAUTION

When removing the depth gauge be sure to disengage the bone hook from the far cortex prior to removal of the instrument in order to prevent fractures and damage to the depth gauge's tip or damage to the glenoid baseplate.

⚠ CAUTION

During drilling, make sure to use the power instruments in "DRILL" mode or be sure to utilize drill specific attachments for proper RPM and torque settings.

⚠ WARNING

The 3.1mm drill bit is a SINGLE USE ONLY instrument.
Do not use the drill bit outside of the provided peripheral drill guides during peripheral screw preparation.

Glenoid preparation



Figure 85

Peripheral screw placement

The intent of peripheral screw placement should be to engage the maximum amount of good quality bone stock available with the appropriate length screws.

Taking note of the measurements taken either with the peripheral drill guide or the depth gauge, select the appropriate length screw and verify its length with the screw identification tool built into the case/tray [Figure 85].

Assemble the peripheral screw T25 driver to the 4-sided ratcheting handle and engage onto the selected inferior peripheral screw.

NOTICE

Make sure the peripheral screw is taper locked to the peripheral screw T25 driver before handling the assembly.

Place the selected inferior peripheral screw into the glenoid baseplate and begin to manually tighten the peripheral screw.

Peripheral screws may also be inserted by the use of power tools connected to the driver. Set power tool on "drill" or other low torque setting if available.

CAUTION

High torque or "ream" setting on power tool may result in bone damage.

CAUTION

Ensure that the use of power is stopped before the threaded screw head contacts the baseplate to avoid damage to system components. Seat the screw with the manual 4-sided ratcheting handle.

Glenoid preparation



Figure 86

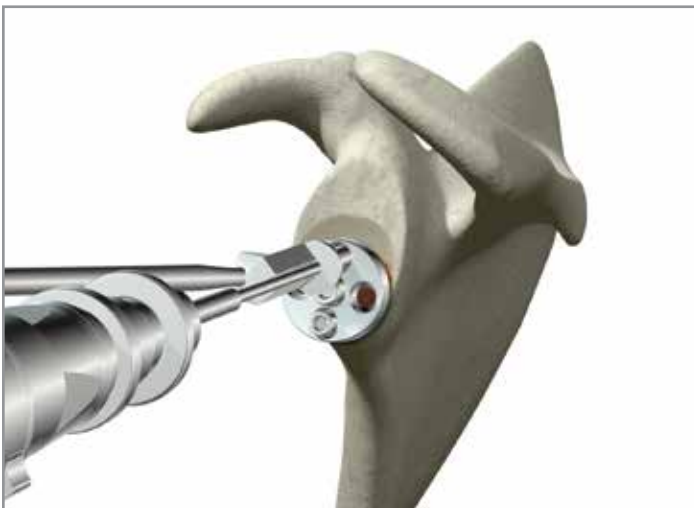

Figure 87

The head of the peripheral screw should be below the level of the surface of the baseplate when it is fully engaged and locked in place.

WARNING

It is important to ensure the screw driver and screw are parallel with each other and fully engaged as you insert the screws.

Deviation from this technique may lead to stripping of the driver and screw interface. Once the screws are fully seated in the baseplate, do not over-tighten.

Repeat above steps for opposing superior screw and then the anterior and posterior screws.

CAUTION

The required minimum number of screws shall be no less than two (2) peripheral screws (superior and inferior) and one (1) center screw.

When possible, four (4) peripheral and one (1) center screw should be used.

Glenoid preparation

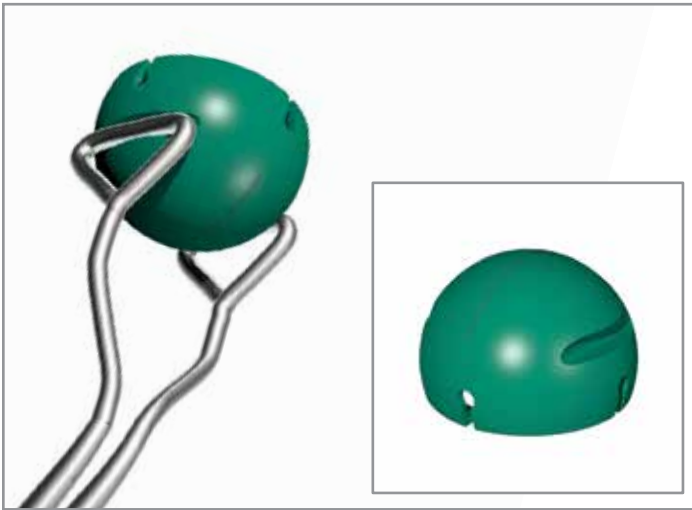

Figure 88

Glenosphere trialing

Select the appropriately sized glenosphere trial [see table below] and determine the eccentricity and lateral offset required for optimum glenosphere placement and ROM.

Glenosphere	32	36	40
Lateral offset (mm)	+2, +6	+2, +6	+2, +6
Eccentricity (mm)	0	0, +2	0, +2, +4

Grasp the glenosphere trials using the glenoid holder instrument [Figure 89] and place the glenosphere trial onto the glenoid baseplate, making sure that the glenosphere trial is completely bottomed out onto the glenoid baseplate.

It is possible to orient the glenosphere eccentricity in any direction including anterior/posterior, which may help with extreme instability. glenosphere trials are marked with an arrow and "ECC" marking to show the orientation of the eccentricity [Figure 90].

WARNING

An eccentric glenosphere placed inferiorly provides the best opportunity to minimize the possibility of scapular notching.



Figure 89

The definitive glenosphere implant can be inserted now or the user can move on to insert the humeral trials and place the definitive glenosphere implant at the conclusion of trialing.

NOTICE

The glenoid holder will be required to remove the glenosphere trial from the glenoid baseplate.

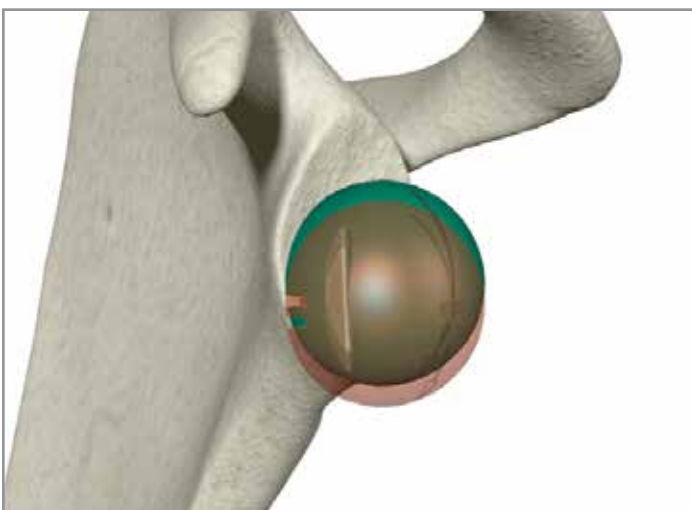

Figure 90

Humeral cup

Insert trialing

Humeral cup/insert trialing

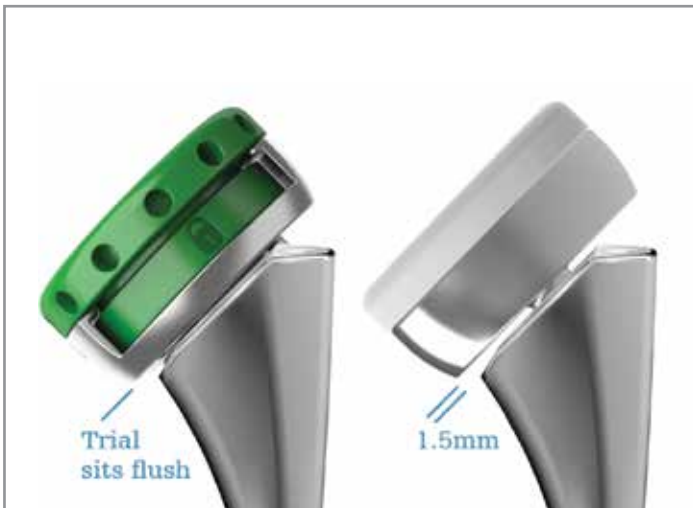

Figure 91

Optional utilization of humeral cup trial adaptors

(Humeral cup trial adaptors are available in the US only)

Humeral cup trials sit flush to the face of the Humeral broaches and cemented humeral stems [Figure 91, left]. In cemented applications, the morse taper adjoining the humeral cup implant with the humeral stem implant adds a nominal thickness of approximately 1.5mm [Figure 91, Right].

NOTICE

Humeral cup trial adaptors are only applicable to cemented humeral stem applications.



Figure 92

For this reason, single-use/sterile humeral cup trial adaptors are available for optional utilization with ReUnion RSA humeral cup trials. Utilization of the trial adaptors will account for the additional nominal 1.5mm gap introduced by the morse taper.

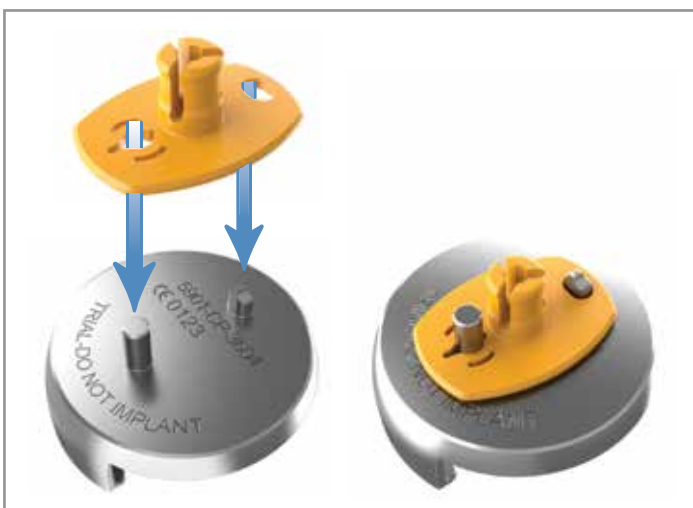

Figure 93

Humeral cup trial adaptors mate with ReUnion RSA humeral cup trials and expanding cup trials. To determine the size of the humeral cup trial, please refer to the “humeral cup/insert trialing” section.

Place the flat side of the humeral cup trial adaptor on the bottom face of the selected humeral cup trial assembly. The longer straight pin on the humeral cup trial fits through the smaller circular hole surrounded by cutouts, while the oblong pin fits through the corresponding oblong hole in the adaptor.

NOTICE

There should be no gap between the bottom face of the humeral cup trial and the top side of the humeral cup trial adaptor.

Humeral cup/insert trialing

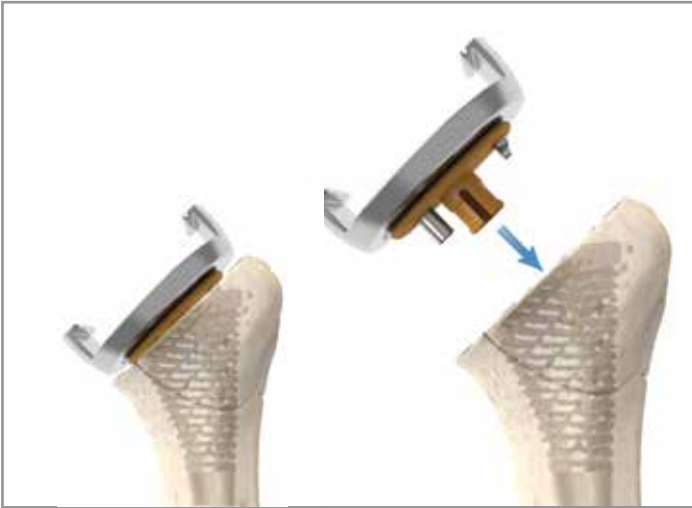

Figure 94

With the shorter oblong pin on the humeral cup trial oriented superiorly and the longer straight pin oriented inferiorly, place the assembled components on the humeral broach or ReUnion TSA cemented humeral stem.

Continue trialing the ReUnion RSA humeral cup trial assemblies as described in the “humeral cup/insert trialing” section.

If an alternate humeral cup trial is desired, remove the humeral cup trial adaptor from the previous humeral cup trial and assemble it to the new trial as previously described.

Tech tip:

The forked removal tool can aid in humeral cup trial adaptor removal. See the “humeral cup trial adaptor disassembly” section.



Figure 95

Humeral cup/insert trialing

The ReUnion RSA shoulder system has 3 methods of humeral cup/insert trialing available.

1. Expanding humeral cup trial and expanding humeral trial insert.
2. Sliding humeral cup trial and humeral insert trial
3. Traditional humeral cup implant and humeral insert trial

All three methods are intended to provide accurate assessment of deltoid tension for optimal range of motion and joint stability.

Humeral cup/insert trialing



Figure 96

Expanding humeral trial

Expanding humeral cup trials	Humeral construct size range
Small (Sizes 32, 36, and 40)	12mm - 18mm (2mm incr.)
Large (Sizes 32, 36, and 40)	16mm - 22mm (2mm incr.)

Select the appropriately sized expanding insert trial [see table above]. Both small and large insert trials are color coded to match the three different diameters of glenospheres.

Tech tip:

Select a small insert trial if you anticipate a tighter joint; select a large insert trial if you anticipate a looser joint.

Constrained X3 humeral inserts are available and capture more of the glenosphere. The polyethylene walls are higher than standard bearings, but do not add any additional joint space.

NOTICE

The metal expandable humeral cup trials only come in one size, but are able replicate both 4 and 10mm humeral cup options.

Insert the selected expanding insert trial into the expanding humeral cup trial and rotate clockwise until it is in its collapsed state [Figure 96].

Place the assembled trial on the humeral broach by placing the long straight pin on the inferior hole perpendicular to the resection plane. Reduce (relocate) the joint with the trial fully collapsed to facilitate the reduction maneuver.

NOTICE

If utilization of the optional humeral cup trial adaptor is desired, follow instructions for attachment to expanding humeral cup trial prior to placement on the humeral broach/cemented humeral stem.

Perform an initial reduction with the collapsed trial, making sure to minimize the amount of tension on the deltoid.

As the trial is expanded and tension placed on the deltoid, the markings will correspond to the humeral cup and humeral insert thicknesses.



Figure 97

Humeral cup/insert trialing

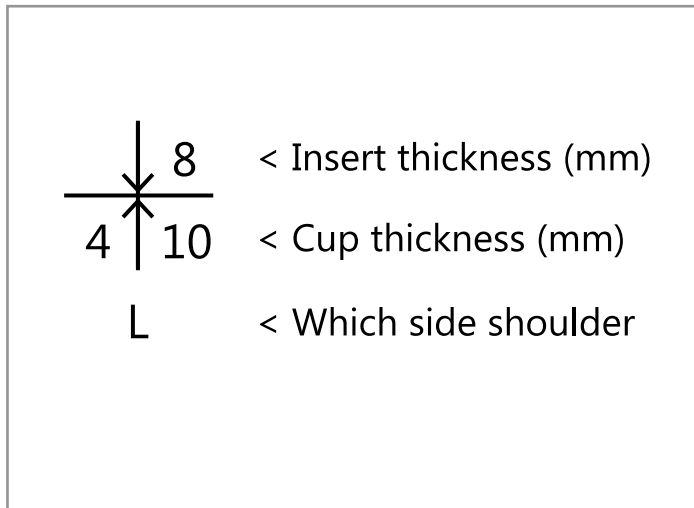

Figure 98

In the example provided in Figure 97 and 98, a 8mm thick X3 humeral insert would be used with a 10mm thick humeral cup, in a left (L) shoulder.

NOTICE

The top number represents the humeral insert thickness (mm). The bottom numbers (4 and 10) represent the humeral cup thickness (mm). The L or R represent which side shoulder is being trialed.

Using the unthreaded portion of the version rod, expand the expanding insert trial until the entire construct begins to apply tension to the deltoid.

Progressively expand the trial with the shoulder reduced by turning the expanding trial counterclockwise. Each turn will increase the thickness of the construct by 2mm.

WARNING

Do not overly tension the deltoid as this may cause damage to bone and soft tissue.



Figure 99

The trial reduction should show very limited distraction (1mm or less). In cases of extreme instability, constrained humeral bearings are available.

Constrained X3 humeral inserts capture more of the glenosphere and have polyethylene walls which are higher than the standard X3 humeral insert implants, but do not add any additional joint space.

If the appropriate amount of tension is achieved for optimal range of motion, the component size markings on the lateral aspect of the expanding trial construct should be recorded for final prosthesis selection.

Prior to removal, the expanding trial should be compressed back to its original state, releasing the tension from the deltoid so that the instrument can be removed easily.

CAUTION

If optional humeral cup trial adaptor is being utilized, ensure that it is properly detached from the humeral cup trial assembly/humeral broach and is not left in the wound.



Figure 100

Humeral cup/insert trialing



Figure 101



Figure 102

Sliding humeral cup trial and humeral trial insert

Humeral trials	Humeral construct size range
Sizes 32, 36, and 40	6mm - 22mm (2mm incr.)

Select the appropriately sized humeral cup trial and humeral insert trial [see table above].

Engage the humeral insert trial into the humeral cup trial by sliding the insert into position and turning it by hand or using the non-threaded end of the version rod to “lock” the trial insert into place [Figure 102].

NOTICE

If utilization of the optional humeral cup trial adaptor is desired, follow instructions for attachment to humeral cup trial prior to placement on humeral broach.

Place the assembled humeral cup trial and humeral insert trial onto the humeral broach in preparation for a trial reduction by placing the long straight pin on the inferior hole perpendicular to the resection plane.

Perform an initial trial reduction to determine the appropriate amount of tension on the deltoid for optimal stability and range of motion.

The trial reduction should show very limited distraction (1mm or less). In cases of extreme instability, constrained X3 humeral inserts are available.

Tech tip:

Constrained X3 humeral inserts are available and capture more of the glenosphere. The polyethylene walls are higher than standard bearings, but do not add any additional joint space.

WARNING

Do not overly tension the deltoid as this may cause damage to bone and soft tissue.

Humeral cup/insert trialing



Figure 103

If the appropriate amount of tension is achieved for optimal stability and range of motion, distract the humeral insert trial and humeral cup trial by first rotating the humeral insert trial from a “locked” position to an “unlocked” position by using the non-threaded end of the version rod [Figure 103].

To distract the humeral trial components, place the arm in slight abduction and external rotation to align the trial components with the glenosphere/glenoid.

Distract the trial implant by translating the humerus and humeral cup trial anteriorly until the humeral cup trial is free of the humeral insert trial.

The humeral insert trial shall remain engaged to the glenosphere and can then be removed separately.

CAUTION

If optional humeral cup trial adaptor is being utilized, ensure that it is properly detached from the humeral cup trial assembly/humeral broach and is not left in the wound.

Humeral cup/insert trialing



Figure 104

Traditional humeral trialing (humeral trial insert and humeral cup implant)

Humeral cup trials	Humeral construct size range
Sizes 32, 36, and 40	6mm - 22mm (2mm incr.)

With the definitive humeral cup locked to the humeral stem, placed the selected humeral insert trial into the definitive humeral cup and reduce the joint [Figure 104].

If the appropriate amount of tension is achieved for optimal stability and range of motion, distract the joint and extract the humeral insert trial from the definitive humeral cup.



Figure 105

Component size selection

The ReUnion RSA Reverse Shoulder System comes with a large range of implant sizes to accommodate all ranges of glenohumeral instability and/or rotator cuff deficiency.

NOTICE

There are often multiple combinations of humeral cup and insert options to achieve a desired final construct thickness. When creating a construct it is recommended to use a thicker metal humeral cup component versus a thicker X3 humeral insert.

		X3 Humeral inserts [mm]				
		4	6	8	10	12
Humeral cup [mm]	2	6	8	10	12	14
	4	8	10	12	14	16
	10	14	16	18	20	22

Final implant insertion

Final implant insertion

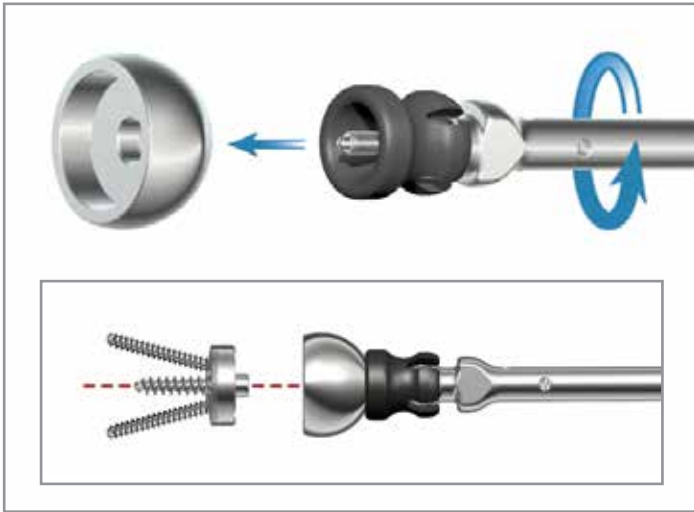

Figure 106

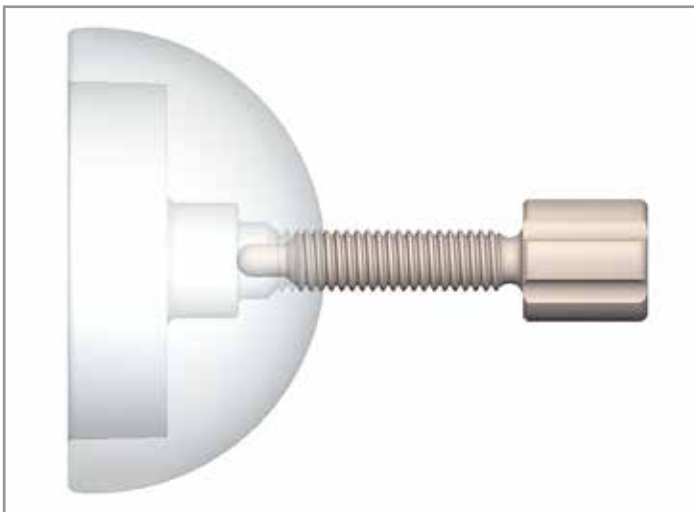

Figure 107

*glenosphere cross-section image shown

Glenosphere placement

Engage the desired definitive glenosphere on the glenosphere holder/impactor and place the glenosphere onto the glenoid baseplate [Figure 106]. Ensure that the assembly is fully tightened and there is no gap between the glenosphere and the grey impactor tip.

If using an eccentric glenosphere, use the eccentric alignment mark on the glenosphere impactor tip and align it to the laser mark on the underside of the eccentric glenosphere to place the glenosphere in the optimum orientation as trialed.

Optional technique:

The glenosphere may also be inserted by the use of the jackscrew or by hand.

For insertion via jackscrew, insert the jackscrew into the glenosphere so that the screw does not extend entirely through the glenosphere, (Figure 107). The jackscrew must be inserted into the glenosphere between three and four threads. Hold the jackscrew manually to initially place the glenosphere onto the baseplate. Once the glenosphere is placed, remove the jackscrew before proceeding.

For hand insertion, hold the glenosphere and place the glenosphere onto the baseplate. Using the 4-sided modular ratcheting handle and universal impactor tip, exert several mallet blows to definitively seat the glenosphere.

⚠ CAUTION

Do not impact the glenosphere until the jackscrew has been removed.

Final implant insertion

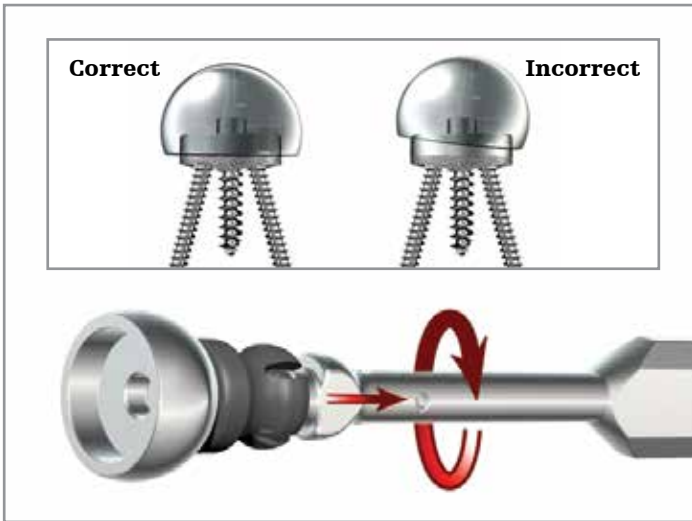

Figure 108

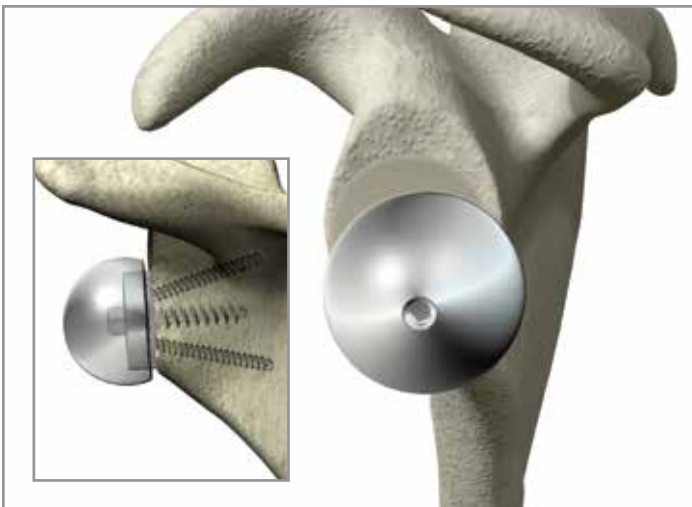

Figure 109

⚠ CAUTION

Confirm there is adequate soft tissue clearance within the envelope of the baseplate to ensure glenosphere to baseplate taper lock.

⚠ CAUTION

Constrained X3 humeral inserts are available and capture more of the glenosphere. The polyethylene walls are higher than standard bearings, but do not add any additional joint space.

Prior to impaction, make sure the glenosphere and baseplate tapers are aligned and that there are no protruding bone ledges or interposed soft tissue that may impede full seating of the glenosphere.

Definitively seat the glenosphere by placing several sharp blows on the glenosphere holder/impactor. Final impaction may also be completed using the universal impactor from the ReUnion TSA system. This is required if the glenosphere was placed using the optional jackscrew insertion method. A set screw is not needed to attach the glenosphere to the glenoid baseplate.

The design of the morse taper provides a secure mode of fixation. Ensure that the glenosphere is still fully tightened onto the glenosphere holder/impactor and use the handle to make sure the taper is fully seated after impaction by gently toggling in all directions.

If the morse taper has not been engaged, toggling of the handle will disengage the glenosphere from the baseplate.

⚠ CAUTION

It is critical to ensure that all tapers are clean, dry and clear of any debris or damage prior to assembling the glenosphere to the glenoid baseplate.

Final implant insertion



Figure 110

To detach the glenosphere holder/impactor from the glenosphere after it has been impacted in place, unthread the instrument counter-clockwise until it is free [Figure 108].

After the removal of the glenosphere holder/impactor, inspect the glenosphere for placement and clean the articulating surface of all debris.

Humeral cup and insert assembly press-fit stem application

NOTICE

To prepare the ReUnion S Humeral Assembly Block insert the male end of the Upper Deck piece (5901-4005) into the female end of the Lower Deck piece (5901-4006) [Figure 110].

Place the definitive humeral cup implant into the humeral assembly block.

Position the definitive X3 humeral insert on top of the definitive humeral cup.

Attach the appropriately sized humeral insert impactor tip to the universal impactor adaptor and attach the assembly to the 4-Sided handle.

While holding the humeral assembly block steady, impact the definitive X3 humeral insert into the definitive humeral cup using several sharp blows of the mallet [Figure 111, inset].

The assembled definitive humeral cup and X3 humeral insert are now locked and ready to be inserted onto the definitive humeral stem.

CAUTION

Optional humeral cup trials are limited to cemented humeral stem applications and should not be utilized in press-fit applications.

It is critical to ensure that all tapers are clean, dry and clear of any debris or damage prior to assembling the humeral cup to the stem

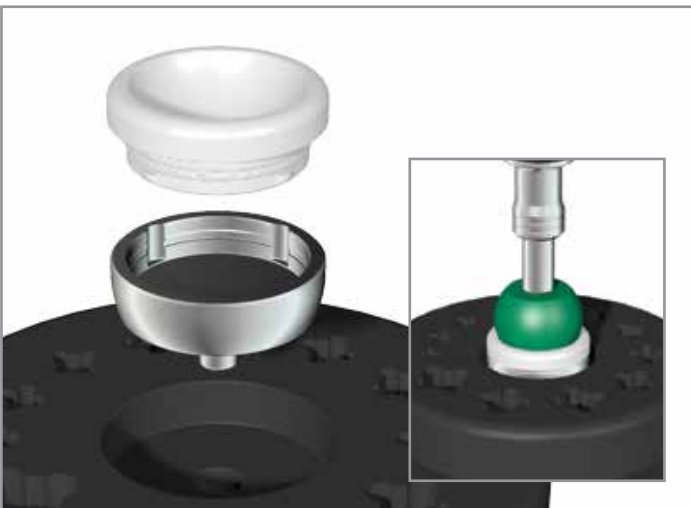

Figure 111

Final implant insertion



Figure 112

Place the humeral cup and X3 humeral insert assembly onto the taper of the humeral stem [Figure 112].

The humeral stem should not be fully seated as to allow space for a sufficient taper lock of the humeral cup and X3 humeral insert assembly to the humeral stem.

Several sharp mallet blows are used to seat the humeral cup and X3 humeral insert assembly until the backside of the humeral cup is flush to the resection. Be sure the angle of the driver is in line with the axis of the trunnion (90° to humeral cup face) [Figure 113].



Figure 113

WARNING

Excessive impaction on a properly seated humeral stem may potentially cause a fracture of the medial calcar or humeral shaft.

Reduce the joint and assess the final range of motion. The final reduction should show very limited distraction (1mm or less).

Impingement should not be present in either adduction or abduction. If impingement occurs in abduction, a greater tuberosity osteotomy or tuberoplasty may be necessary.

NOTICE

Attention must be paid to version of the implant.

With either cemented or press-fit application, expanding humeral trials or humeral trial cups may be again used to evaluate adequacy of range of motion, soft tissue tensioning and to check for impingement.

When trialing off of the proud press-fit stem, care should be taken to assess the anticipated final seating height.



Figure 114

Final implant insertion



Figure 115

Options for cemented stem application

For cemented stems, the ReUnion RSA has three options for definitive component placement [see table below].

⚠ CAUTION

If the humeral resection plane is compromised, it may prevent the humeral cup from sitting appropriately flush to the resection plane, potentially affecting humeral component version. In this event, option 3 (see table below) must be used.

Method of assembly	Trialing Options
1. Stem + Cup + X3 insert (back table)	Expanding, sliding, traditional
2. Stem + Cup (back table), X3 insert (in-vivo)	Expanding, sliding, traditional
3. Stem, Cup, X3 insert (in-vivo individually)	Traditional

Final implant insertion



Figure 116

Option 1: Complete back table assembly and monoblock insertion

CAUTION

Prior to monoblock insertion into the cement mantle, surgeon must inspect the resection plane to ensure the humeral cup can be seated flush to the resection.

NOTICE

To prepare the ReUnion S Humeral Assembly Block insert the male end of the Upper Deck piece (5901-4005) into the female end of the Lower Deck piece (5901-4006) [Figure 116].



Figure 117

Place the definitive humeral cup implant into the humeral assembly block.

Position the definitive X3 humeral insert on top of the definitive humeral cup [Figure 117].

Attach the appropriately sized humeral insert impactor tip to the universal impactor adaptor and attach the assembly to the 4-Sided handle.

While holding the humeral assembly block steady, impact the definitive X3 humeral insert into the definitive humeral cup using several sharp blows of the mallet [Figure 117, inset].

Final implant insertion



Figure 118

The assembled definitive humeral cup and X3 humeral insert are now locked and ready to be inserted onto the definitive humeral stem.

Place the definitive humeral stem into the correct position on the marked humeral assembly block with the stem taper facing outward.

While holding the humeral assembly block steady, impact the humeral cup and X3 humeral insert assembly into the humeral stem using several sharp blows to lock the assembly. Be sure the angle of the driver is in line with the axis of the trunnion (90° to humeral cup face).

The monoblock assembly (humeral stem, humeral cup, and X3 humeral insert) is now ready to be inserted into the cement mantle.

Insert the monoblock assembly into the cement mantle. Surgeon must ensure that the back surface of the humeral cup is flush to the resection plane [Figure 119].

Reduce the joint and assess the final range of motion. The final reduction should show very limited distraction (1mm or less).

Impingement should not be present in either adduction or abduction. If impingement occurs in abduction, a greater tuberosity osteotomy or tuberopectomy may be necessary.



Figure 119

Final implant insertion



Figure 120

Option 2: Back table assembly of the humeral cup and cemented stem

CAUTION

Prior to monoblock insertion into the cement mantle, surgeon must inspect the resection plane to ensure the humeral cup can be seated flush to the resection.

NOTICE

To prepare the ReUnion S Humeral Assembly Block insert the male end of the Upper Deck piece (5901-4005) into the female end of the Lower Deck piece (5901-4006) [Figure 120].



Figure 121

Place the definitive humeral stem into the correct position on the marked humeral assembly block with the stem taper facing outward.

Position the definitive humeral cup onto the definitive humeral stem.

Attach the universal impactor tip to the universal impactor adaptor and attach the assembly to the 4-sided handle.

While holding the humeral assembly block steady, impact the humeral cup into the humeral stem using several sharp blows to lock the humeral cup into the humeral stem. Be sure the angle of the driver is in line with the axis of the trunnion (90° to humeral cup face).

Final implant insertion



Figure 122

The monoblock assembly (humeral stem and humeral cup) is now ready to be inserted into the cement mantle.

Insert the monoblock assembly into the cement mantle. Surgeon must ensure that the back surface of the humeral cup is flush to the resection plane [Figure 122].

Place the definitive X3 humeral insert selected during trialing onto the humeral cup.

Attach the appropriately sized humeral insert impactor tip to the 4-sided handle.

Apply several sharp mallet blows to lock the X3 humeral insert to the humeral cup. Be sure the angle of the driver is in line with the axis of the trunnion (90° to humeral cup face).

Reduce the joint and assess the final range of motion. The final reduction should show very limited distraction (1mm or less).

Impingement should not be present in either adduction or abduction. If impingement occurs in abduction, a greater tuberosity osteotomy or tuberopectomy may be necessary.



Figure 123

Final implant insertion



Figure 124

Option 3: In-vivo individual assembly of cemented humeral stem, humeral cup, and X3 humeral insert

⚠ CAUTION

If optional humeral cup trial adaptor is being utilized, ensure that it is disassembled and removed prior to impacting the humeral cup implant.

⚠ CAUTION

If optional humeral cup trial adaptor is being utilized, ensure that it is properly detached from the humeral cup trial/cemented humeral stem and is not left in the wound.



Figure 125

Place the definitive humeral cup implant onto the cemented humeral stem [See Figure 124].

Attach the universal impactor tip to the universal impactor adaptor and attach the assembly to the 4-sided handle.

Impact the humeral cup into the humeral stem using several sharp blows to lock the humeral cup into the humeral stem. Be sure the angle of the driver is in line with the axis of the trunnion (90° to humeral cup face) [Figure 125].

Place the X3 humeral insert onto the humeral cup.

Attach the appropriately sized humeral insert impactor tip to the 4-sided handle.

Several sharp mallet blows are used to seat the X3 humeral insert into the humeral cup. Be sure the angle of the driver is in line with the axis of the trunnion (90° to humeral cup face).

Reduce the joint and assess the final range of motion. The final reduction should show very limited distraction (1mm or less).

Impingement should not be present in either adduction or abduction. If impingement occurs in abduction, a greater tuberosity osteotomy or tuberopectomy may be necessary.



Figure 126

Appendix

Implant removal



Figure 127

Humeral stem removal

⚠ WARNING

Do not use the broach handle/stem inserter for removal of a well fixed or cemented humeral stem.

Utilize the humeral stem removal tool and McReynolds slap hammer to remove the humeral stem from the humeral canal.

Attach the humeral stem extractor to the humeral stem by inserting the guide post into proximal hole of the stem. Engage the clamping arm into trunnion, then tighten the knob.

Depending on the integrity of the cement mantle or degree of humeral stem ingrowth, humeral shaft osteotomies and other techniques described in the peer reviewed literature may be justified.



Figure 128

Thread the McReynolds slap hammer attachment to the humeral stem extractor and apply upward thrusts in line with the long axis of the humerus and well fixed humeral stem.

⚠ WARNING

Do not apply cantilever loads while sliding the hammer to remove the stem as this may cause a fracture of the humerus.

Implant removal



Figure 129



Figure 130



Figure 131

Humeral poly insert removal

Dislocate the glenohumeral joint so that the X3 humeral insert is exposed.

Use the 3.1mm drill bit and drill a pilot hole into the X3 humeral insert at an oblique angle.

Drive the 3.1mm drill bit to the flat bottom surface of the humeral cup away from the sides and the locking features of the X3 humeral insert.

Assemble the polyethylene removal tool to the 4-sided handle and introduce the tip of the polyethylene removal tool into the prepared pilot hole at the same oblique angle.

Drive the polyethylene removal tool into the X3 humeral insert until the insert disassociates from the humeral cup.

⚠ CAUTION

After the X3 humeral insert has been removed, make sure that the joint space is completely clean and clear of any and all debris and polyethylene particles.

Humeral cup removal

Attach the forked removal tool to the 4-sided handle and slide the forked removal tool under the humeral cup.

Align the forked removal tool to the neck of the humeral cup and lightly tap the forked removal tool in with a mallet to mechanically disassociate the humeral cup from the humeral stem.

If the humeral cup is in direct contact with the bone, the surgeon may need to create a small window along the edge of the resection to obtain access for insertion of the fork.

Implant removal



Figure 132

Glenosphere removal

With the glenohumeral construct distracted and the glenosphere fully exposed. Introduce the glenosphere jackscrew into the threaded hole at the top of the glenosphere.



Figure 133

Utilizing the center screw T25 driver, begin to thread in the glenosphere jackscrew until the glenosphere distracts completely from the glenoid baseplate.

Instrument disassembly



Figure 134

Disassembly of glenoid reamer/planar

The following disassembly instructions are applicable for all reamer styles (standard, magnetic & half-moon).

The recommended method to disassemble the glenoid reamer/planars from the cannulated straight reamer driver is by utilizing the glenoid holder to grasp around the circumference of the glenoid reamer/planar.

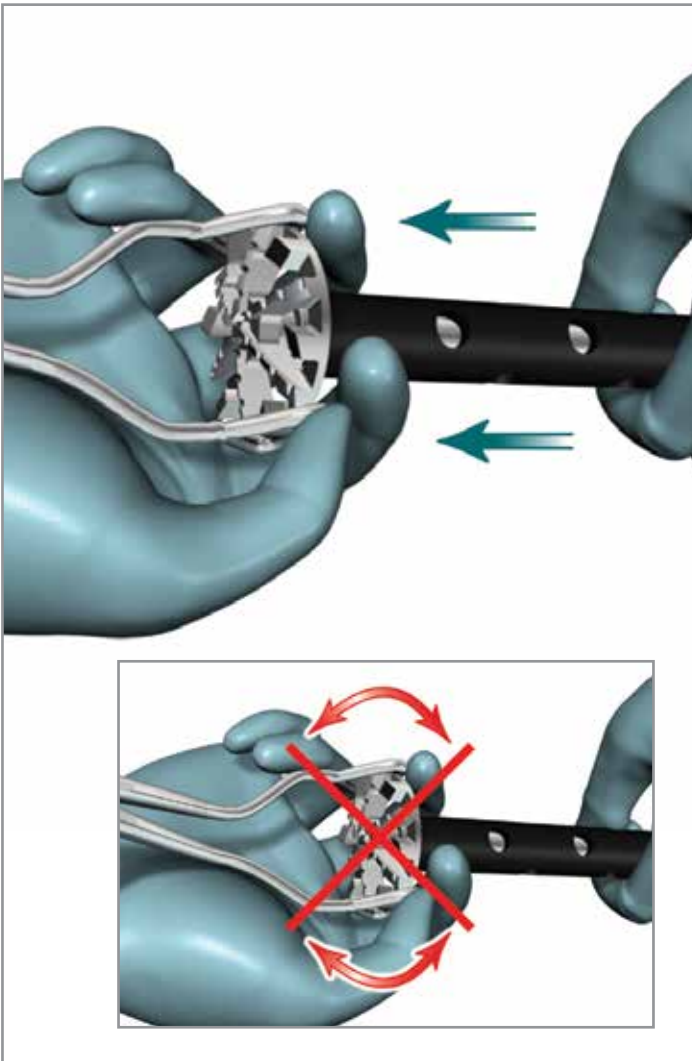

Figure 135

By holding the reamer/planar face as shown [Figure 135] with the glenoid holder, pull the glenoid reamer/planar face away from cannulated straight reamer driver in an axial direction to disengage the quick connect feature.

⚠ WARNING

Do not toggle the glenoid reamer/planar during disassembly as this has the potential to compromise the fit of the quick connect mechanism [Figure 135, inset].

Instrument disassembly

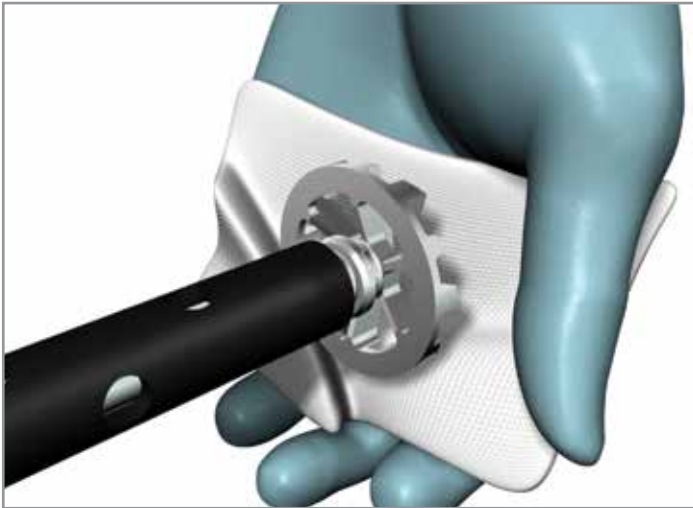

Figure 136

If attempting to remove the glenoid reamer/planar without use of the glenoid holder, it is recommended the user utilize gauze or another material to protect their hands from blades of the reamer.



Figure 137

Humeral cup trial adaptor disassembly

Attach the forked removal tool to the 4-sided ratcheting handle.

Slide the forked removal tool between the humeral cup trial and the humeral cup trial adaptor. Ensure that the flat side of the forked removal tool faces the bottom side of the humeral cup trial and the ramped side faces the humeral cup trial adaptor.

Carefully disassemble the humeral cup trial adaptor from the humeral cup trial.

Stem sizing chart



Press-fit stems			
Standard stems	Standard stem length	ReUnion S stems	ReUnion S stem length
5569-P-2007	113 mm	5567-P-3007	91 mm
5569-P-2008	118 mm	5567-P-3008	92 mm
5569-P-2009	118 mm	5567-P-3009	93 mm
5569-P-2010	123 mm	5567-P-3010	94 mm
5569-P-2011	123 mm	5567-P-3011	95 mm
5569-P-2012	128 mm	5567-P-3012	96 mm
5569-P-2013	128 mm	5567-P-3013	97 mm
5569-P-2014	133 mm	5567-P-3014	98 mm
5569-P-2015	133 mm	5567-P-3015	99 mm
5569-P-2016	140 mm	5567-P-3016	101 mm
5569-P-2017	140 mm	5567-P-3017	102 mm
		5567-P-3018	103 mm
		5567-P-3019	104 mm
		5567-P-3020	105 mm

Cemented stems			
Standard stems	Standard stems	ReUnion S stems	ReUnion S stem length
5569-C-2006	113 mm	5567-C-3006	89 mm
5569-C-2106L	152 mm		
5569-C-2007	113 mm	5567-C-3007	91 mm
5569-C-2008	118 mm	5567-C-3008	92 mm
5569-C-2108L	200 mm		
5569-C-2009	118 mm	5567-C-3009	93 mm
5569-C-2010	123 mm	5567-C-3010	94 mm
5569-C-2110L	200 mm		
5569-C-2011	123 mm	5567-C-3011	95 mm
5569-C-2012	128 mm	5567-C-3012	96 mm
5569-C-2112L	200 mm		
5569-C-2013	128 mm	5567-C-3013	97 mm
5569-C-2014	133 mm	5567-C-3014	98 mm
5569-C-2015	133 mm	5567-C-3015	99 mm
		5567-C-3016	101 mm
		5567-C-3017	102 mm
		5567-C-3018	103 mm

This document is intended solely for the use of healthcare professionals. A surgeon must always rely on his or her own professional clinical judgment when deciding whether to use a particular product when treating a particular patient. Stryker does not dispense medical advice and recommends that surgeons be trained in the use of any particular product before using it in surgery.

The information presented is intended to demonstrate a Stryker product. A surgeon must always refer to the package insert, product label and/or instructions for use, including the instructions for cleaning and sterilization (if applicable), before using any Stryker product. Products may not be available in all markets because product availability is subject to the regulatory and/or medical practices in individual markets. Please contact your Stryker representative if you have questions about the availability of Stryker products in your area.

The instructions for use, operative techniques, cleaning instructions, patient information leaflets and other associated labeling may be requested online at www.ifu.stryker.com or www.stryker.com. If saving the instructions for use, operative techniques, cleaning instructions from the above mentioned websites, please make sure you always have the most up to date version prior to use.

Stryker Corporation or its divisions or other corporate affiliated entities own, use or have applied for the following trademarks or service marks: ReUnion, Stryker, X3. All other trademarks are trademarks of their respective owners or holders.

This document is applicable to the United States.

Content ID: RU-ST-16_Rev-5, 10-2021

Copyright © 2021 Stryker



Manufacturer:

Stryker GmbH
Bohnackerweg 1
2545 Selzach
Switzerland

stryker.com