

PangeaTM

Humerus Plating System



Operative Technique

Extra Articular Distal Humerus

Contents

Indications and contraindications	3
Pangea introduction	4
Section 01: Pangea Overview	5
Trays	6
Color coding	8
Small and large fragment trays	9
Instrumentation	11
Section 02: System Overview Pangea Humerus Plating	
System Distal Humerus	18
Required trays	19
Distal Humerus Plate offering	20
Screw offering	21
Plate details	22
Section 03: Surgical Protocol Pangea Humerus Plating	
System Distal Humerus	23
Preoperative planning	24
Surgical approaches and instrumentation	26
Reduction and plate contouring	27
Plate insertion	28
Provisional plate positioning	29
Non-locking screw insertion	30
Locking screw insertion	31
Lag screw technique	32
Compression technique	33
Cables and cable plugs	34
Final constructs	35
Packaging details	36
Section 04: System Components	37

This publication sets forth detailed recommended procedures for using Stryker devices and instruments. It offers guidance that you should heed, but, as with any such technical guide, each surgeon must consider the particular needs of each patient and make appropriate adjustments when and as required.

This document is applicable to US and Canada.

The surgeon must advise patients of surgical risks and make them aware of adverse effects and alternative treatments.

WARNING

The patient should be advised that the device cannot and does not replicate a normal healthy bone, that the device can break or become damaged as a result of strenuous activity or trauma and that the device has a finite expected service life.

Removal or revision of the device may be required sometime in the future due to medical reasons.



Pangea Platform indications

The Pangea Platform is indicated for the internal fixation and stabilization of bone fractures, osteotomies, and arthrodesis in normal and osteopenic bone, including:

- Diaphyseal, metaphyseal, epiphyseal, extra- and intra-articular fractures
- Non-unions, malunions, and deformities
- Periprosthetic fractures

The Pangea Platform is also indicated for children (2-12 years) and adolescents (12 – 21 years) for the internal fixation and stabilization of bone fractures of the diaphysis and metaphysis in which growth plates have fused or in which growth plates will not be crossed by implants.

Pangea Humerus Plating System indications

The Pangea Humerus Plating System is indicated for the internal fixation and stabilization of humerus bone fractures and osteotomies in normal and osteopenic bone, including:

- Diaphyseal, metaphyseal, epiphyseal, extra- and intra-articular fractures
- Non-unions, malunions, and deformities
- Periprosthetic fractures

Compatibility with other systems

Components from the Pangea Humerus Plating System may be used with the following systems:

- AxSOS 3
- Stryker Plating System (SPS)
- Dall-Miles cable system
- Pangea Platform

Please remember that the compatibility of different product systems has not been tested unless specified otherwise in the product labeling. Consult instructions for use (www.ifu.stryker.com) for a complete list of potential adverse effects, contraindications, warnings and precautions.

Contraindications

The physician's education, training, and professional judgement must be relied upon to choose the most appropriate device and treatment.

Conditions presenting an increased risk of failure include:

- Any active or suspected latent infection or marked local inflammation in or about the affected area
- Compromised vascularity that would inhibit adequate blood supply to the fracture or the operative site
- Bone stock compromised by disease, infection or prior implantation that cannot provide adequate support and / or fixation of the devices
- Material sensitivity, documented or suspected
- Patients having inadequate tissue coverage over the operative site
- Implant utilization that would interfere with anatomical structures or physiological performance
- Any mental or neuromuscular disorder which would create an unacceptable risk of fixation failure or complications in postoperative care
- Other medical or surgical conditions which would preclude the potential benefit of surgery

WARNING

Follow the instructions provided in our cleaning and sterilization guide (OT-RG-1). All non-sterile devices must be cleaned and sterilized before use.

Multicomponent instruments must be disassembled for cleaning. Please refer to the corresponding assembly / disassembly instructions.

WARNING

Stryker bone screws are not approved or intended for screw attachment or fixation to the posterior elements (pedicles) of the cervical, thoracic or lumbar spine.

Pangea overview

Pangea systems provide small and large fragment plating solutions for fracture treatment. Pangea's plate offerings include both utility and anatomical plates to address various fracture patterns and anatomy. The plates and non-locking screws are produced from titanium alloy (Ti6Al4V ELI), whereas the locking screws are produced from cobalt-chrome alloy (CoCr).

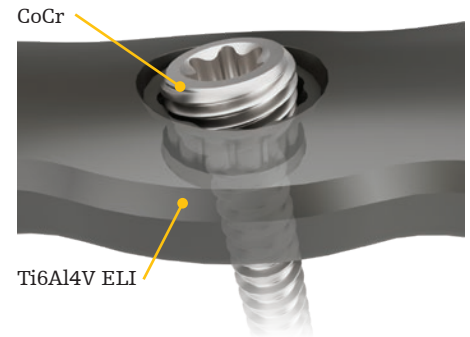

CoCr locking screw and Ti6Al4V ELI plate hole

Variable angle locking technology

Pangea's variable angle locking technology uses a CoCr locking screw, which is harder than the Ti6Al4V ELI plate, allowing for the screwhead's threads to form a definitive locking position in the plate's locking hole by engaging the softer, Ti6Al4V ELI material.

This technology allows the user to aim and lock the screw into the plate within a true 30° cone of the predetermined hole trajectory. The variable angle drill guide provided with the system offers guidance with respect to the limit of the 30° cone. The locking mechanism remains functional for up to three attempts at locking screw insertion.

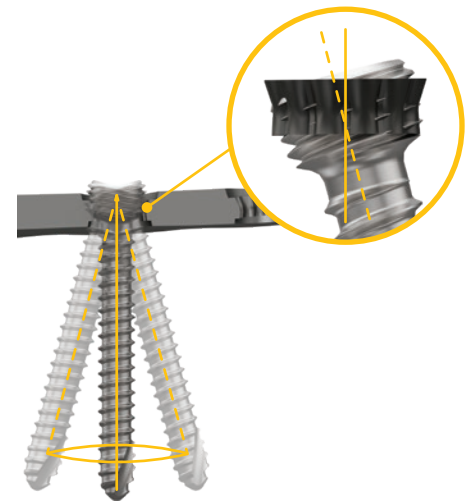

Universal holes offer 30° cone of angulation

Hybrid LC Holes (locking/compression)

Hybrid LC Holes allow for either active compression with the use of a non-locking screw in the compression section of the hole or variable angle locking with the use of a locking screw in the universal section of the hole. If locking is not desired, the universal section of the hole also accepts non-locking screws. Each Hybrid LC Hole is designed to provide up to 2mm of compression.

Note: Hybrid LC Holes are not available with every plate type. Refer to the "Plate details" page for additional information.

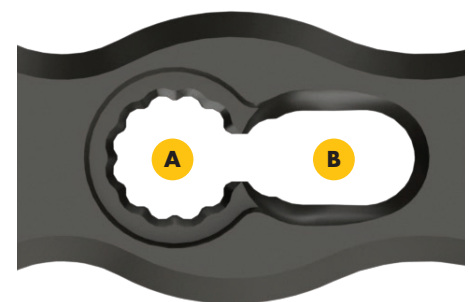

A: Universal: For locking or non-locking screws
B: Compression: For non-locking screws only

Hybrid LC Hole



Section 01

Pangea Overview

Pangea overview

The Pangea systems require the use of a small or large fragment core tray, which contain the necessary instruments and screws to be used for every case. Plates are contained in separate anatomic plate trays, utility plate trays, or optional tray inserts. Some plates are offered sterile packaged only.

Anatomic and utility plate trays contain plates that will correspond to each color code within the small and large fragment core trays. To complete a case, a surgeon will often need an implant tray and its corresponding core tray.

	Small fragment		Large fragment	
Color coding	Purple	Yellow	Orange	Blue
Screw diameters	2.7mm	3.5 / 4.0mm	4.0 / 4.5 / 6.0mm	5.0mm
Screwdriver type				

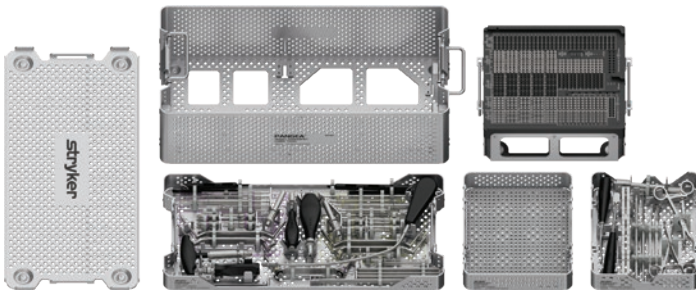

Pangea Small Fragment Core Tray

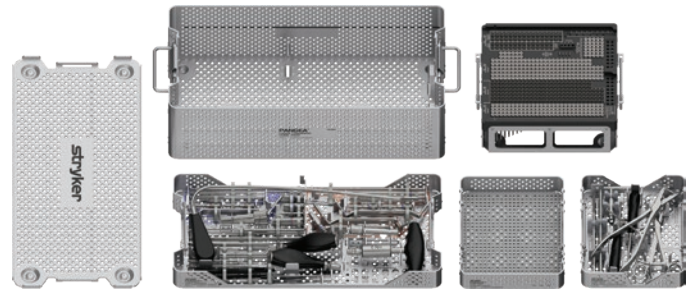

Pangea Large Fragment Core Tray



Auxiliary insert and optional inserts

The Pangea small and large fragment core trays are designed to offer users modularity in their set configurations. Each core tray's standard configuration includes an auxiliary insert containing a silicone mat for storage of miscellaneous instrumentation. Listed below are optional inserts that can be ordered separately and placed into the core tray to meet the user's needs.

When using an optional insert with the Pangea small or large fragment core tray, the auxiliary insert may be replaced with one of the optional inserts.

	Auxiliary insert with silicone mat	Small fragment reduction insert	Large fragment reduction insert	Small fragment standard plate insert	Small fragment ankle plate insert	Asnis III 4.0mm cannulated screw insert
Small fragment core tray	✓	✓		✓	✓	✓
Large fragment core tray	✓		✓			✓

Optional insert configurations

Small fragment utility plate insert

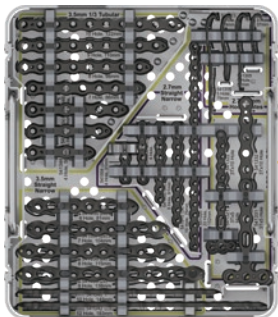

Small fragment ankle plate insert

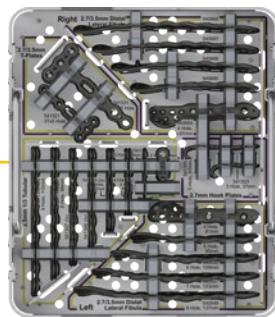

Asnis III 4.0mm cannulated screw insert

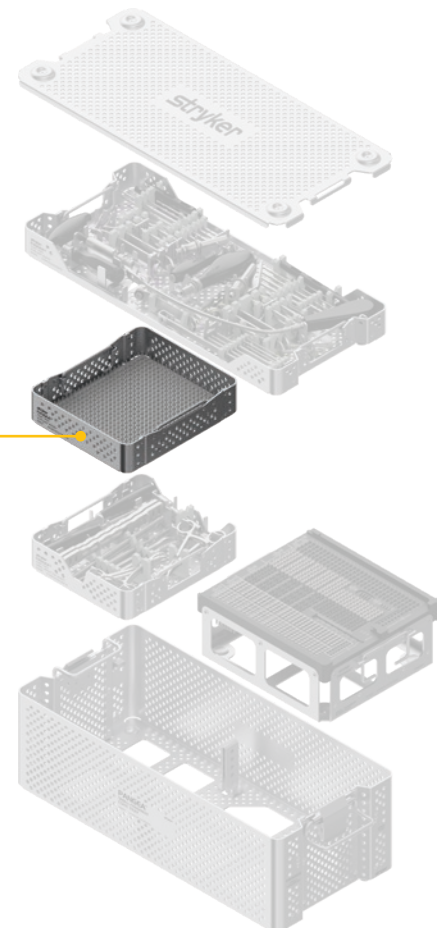













Note: Optional inserts may not be available in all markets. Check with your local Stryker sales representative for availability.





Color coding

The Pangea systems are color-coded to allow the user to easily identify the proper instrumentation for a particular plate type or screw type. Each color represents the proper drill, drill guide, or screwdriver for a particular screw diameter. The small fragment is color-coded purple for 2.7mm screws and yellow for 3.5mm and 4.0mm screws. The large fragment is color-coded orange for 4.0/4.5/6.0mm screws and blue for 5.0mm screws.

The small and large fragment core trays offer short and long drill bits to account for various depths of bone stock. These ORIF pilot drills are calibrated for the surgeon to measure depth by referencing the associated drill guide. ORIF pilot drill bits are identified by one colored stripe, while lag screw overdrills have one colored stripe and one black stripe. The drill bit's diameter can be found on the AO quick connect.

	 Small fragment		 Large fragment	
Screw type	2.7mm cortex 2.7mm locking	3.5mm cortex 3.5mm locking 4.0mm cancellous	4.0mm locking 4.5mm cortex 6.0mm cancellous	5.0mm locking
Color code	Purple	Yellow	Orange	Blue
ORIF pilot drills				
Lag screw overdrills				N/A
ORIF pilot drill lengths	Short: 135mm Long: 175mm	Short: 135mm Long: 215mm	Short: 145mm Long: 215mm	Short: 145mm Long: 215mm
ORIF pilot drill calibrations	Short: 0-40mm Long: 0-80mm	Short: 0-40mm Long: 0-120mm	Short: 0-50mm Long: 0-120mm	Short: 0-50mm Long: 0-120mm
Drill guides				

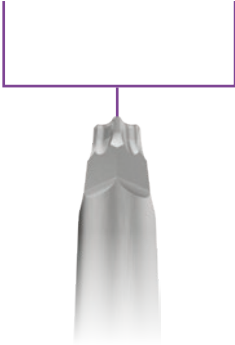
Small fragment core tray set content – 2.7 / 3.5 / 4.0mm screws

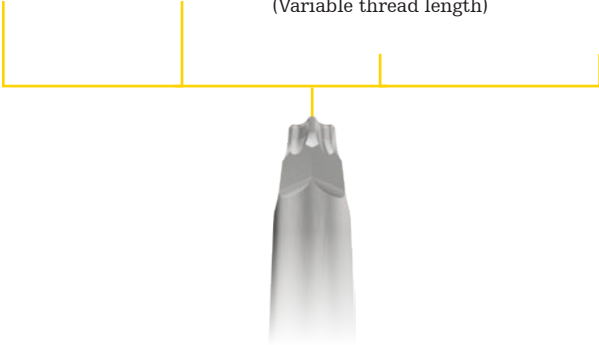
T8 torx interface for all 2.7mm screws	T15 torx interface for all 3.5mm screws and 4.0mm cancellous screws
	
 <p>Ø2.7mm locking Ø2.7mm cortex</p> 	 <p>Ø3.5mm locking Ø3.5mm cortex Ø4.0mm cancellous Partially threaded (Variable thread length) Ø4.0mm cancellous Fully threaded</p> 
2.7mm lag screw drill guide	3.5mm lag screw drill guide
2.0mm pilot drill for 2.7mm screws 2.7mm overdrill for 2.7mm lag screws	2.5mm pilot drills for 3.5 / 4.0mm screws 3.5mm overdrill for 3.5mm lag screws
Torque limiting handle, 1.7Nm for 2.7mm locking screws	Torque limiting handle, 4.0Nm for 3.5mm locking screws
Depth gauge for T8 2.7mm screws	Depth gauge for T15 3.5 / 4.0mm screws
Variable angle drill guides	
Compression drill guide	
Fixed angle guides with drill sleeve inserts	
Small and large Delta screwdriver handles with AO quick connect	
Calibrated soft tissue elevator with distal suture hole for alternative plate insertion techniques	

Small and large fragment trays

Large fragment core tray set content – 4.0 / 4.5 / 5.0 / 6.0mm screws

T20 torx interface for all large fragment screws

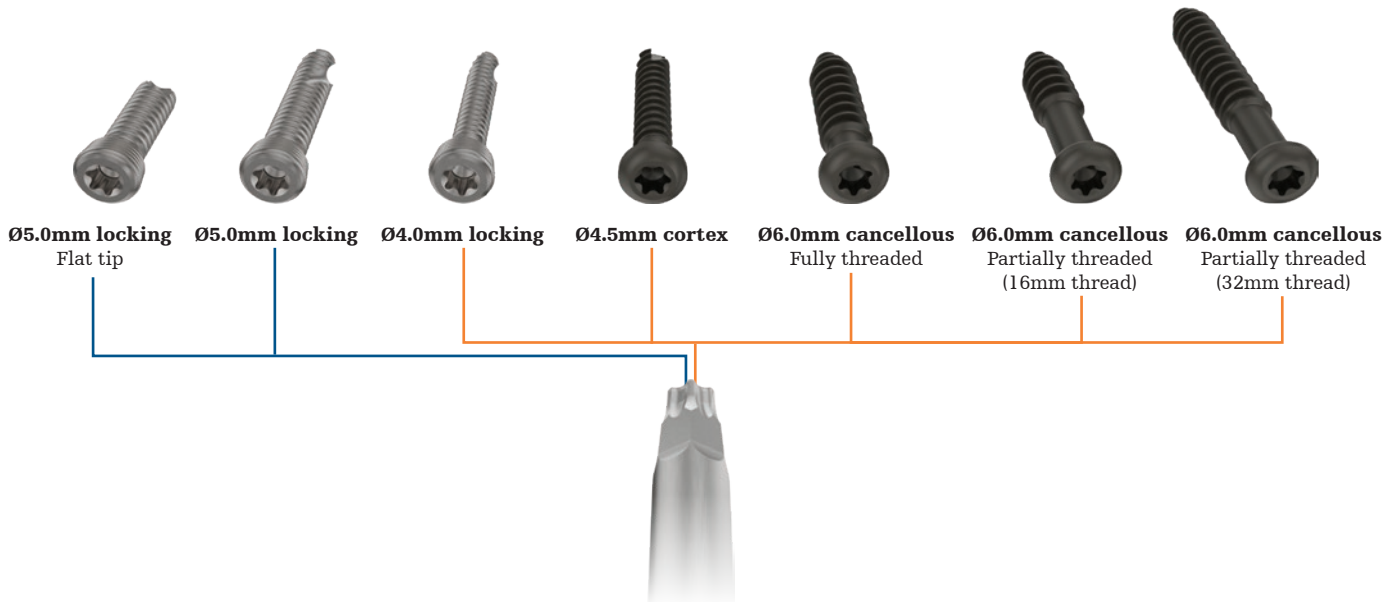

4.5mm lag screw drill guide

3.2mm pilot drills for 4.0 / 4.5 / 6.0mm screws
4.3mm pilot drills for 5.0mm screws
4.5mm overdrill for 4.5mm lag screws

Torque limiting handle, 6.0Nm for 4.0mm and 5.0mm locking screws

Depth gauge for T20 4.0/4.5/5.0/6.0mm screws

Variable angle drill guides

Compression drill guide

Fixed angle guides with drill sleeve inserts

Large Delta screwdriver handles with AO quick connect

Calibrated, curved soft tissue elevator with distal suture hole for alternative plate insertion techniques

Fixed angle drill sleeve

First, the appropriate drill sleeve insert is loosely inserted into the fixed angle sleeve. Next, the entire assembly is inserted into the desired plate hole, which can be confirmed for proper placement with tactile feedback upon insertion. Lastly, turn the drill sleeve insert clockwise to tighten. This fastens the assembly securely to the plate (Fig. 1).

The drill sleeve insert is meant to be hand tightened only. The hex interface on the T8, T15, and T20 screwdriver bits facilitate removal of each respective drill sleeve insert (Fig. 3).

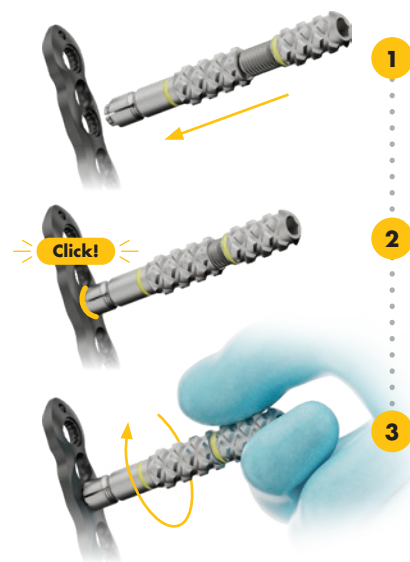

Fig. 1: Fixed angle drill sleeve and insert assembly

Threaded guide post

The T15 and T20 threaded guide posts are intended only for the threaded monoaxial hole in some Pangea plates and serve as the attachment point for MIS targeting capabilities (Fig. 2). Additionally, the threaded guide posts may be utilized as a plate insertion handle, joystick, K-wire sleeve, and drill guide for plates with a threaded monoaxial hole. The threaded guide post is meant to be hand tightened only (Fig. 2).

Note: Threaded monoaxial holes are not available with every plate type. Refer to the “Plate details” page for additional information.

The hex interface on the T20 screwdriver bit facilitates removal of the T20 threaded guide post. The T15 threaded guide post does not have a hex interface and may be removed using the torx portion of the T15 screwdriver bit (Fig. 3).



Fig. 2: Threaded guide post placed in threaded monoaxial hole

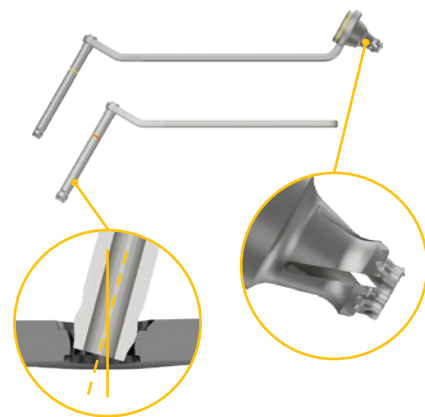

Fig. 3: Hex interface between screwdriver bit, fixed angle drill insert, and T20 threaded guide post

Variable angle drill guide

The ball-and-cone variable angle drill guides are used in combination with their respective drill bit to determine screw trajectory. The color-coded guide restricts the degree of screw angulation to 15° in any direction resulting in a 30° cone of the predetermined hole trajectory.

When using the ball end of the guide, gently press the guide into the plate's universal or Hybrid LC Hole. The ball end of the drill guide can be gently rotated in these holes using the handle while maintaining 15° of angulation. For small fragment indications, to ensure a precise 15° angulation, use the cone end of the variable angle drill guide by engaging the cone end of the guide into the plate hole.



Variable angle drill guide

Lag screw drill guide

Lag screw drill guides are offered to accommodate 2.7mm, 3.5mm, or 4.5mm lag screws. The color-coded guide features an overdrill sleeve with serrated tip for near cortex drilling and a self-centering pilot drill sleeve to complete the lag screw pilot hole. Lag screws may be placed through a plate or independently.

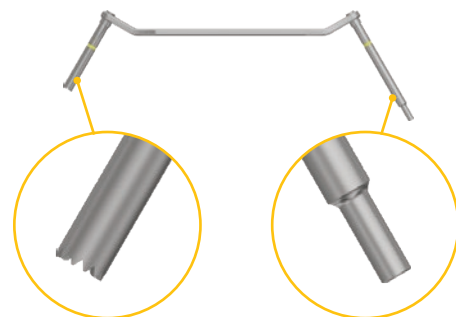

Lag screw drill guide

Compression drill guide



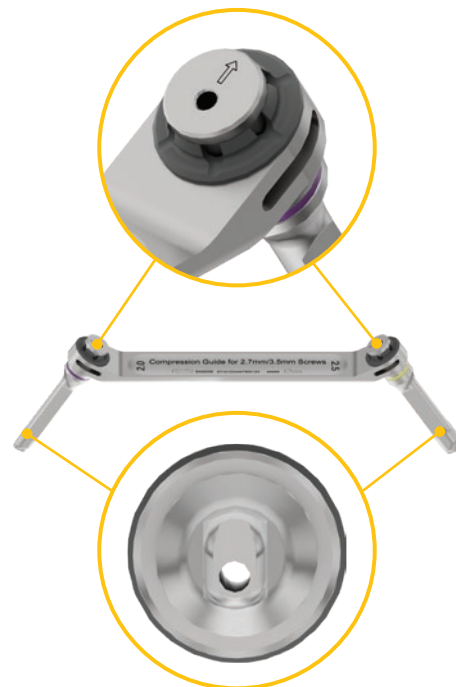



The color-coded compression drill guide is an eccentric drill guide used to apply compression in plates equipped with Hybrid LC Holes. Arrows are inscribed on the guide and must be aimed towards the fracture site when engaged into the plate's Hybrid LC Hole. This allows the user to properly drill the Hybrid LC Hole and achieve up to 2mm of compression upon insertion of a non-locking screw.







Compression drill guide

Handles

Pangea offers multiple handle options. These options include small and large Delta handles, and three torque limiting handles for locking screws. All handles are equipped with a small AO-coupling.

Screwdriver type	Locking screw Ø	Torque	Torque limiting handles
	2.7mm	1.7Nm	
	3.5mm	4.0Nm	
	4.0mm 5.0mm	6.0Nm	

Screwdriver type	Non-locking screw Ø	Small and large Delta handles
	2.7mm 3.5mm 4.0mm 4.5mm 6.0mm	
	2.7mm 3.5mm 4.0mm 4.5mm 6.0mm	

Depth measuring instruments

Pangea systems provide two options for determining screw length.

Drill calibrations

All pilot drills are calibrated to allow the surgeon to determine the appropriate screw length when drilling through either the fixed angle sleeve assembly, threaded guide post, or the ball end of the variable angle drill guide (Fig. 1). The cone end of the variable angle drill guide is not compatible with the calibrated drill bits to determine screw length. The calibrations when read against the selected drill guide measure the distance to the tip of the drill bit.



Fig. 1: Measuring screw length using calibrated drill bit

Depth gauge

A depth gauge can be used independently or through a plate hole. Depth gauges correspond with the screw head size i.e., T8, T15, or T20 (Fig. 2).



Fig. 2: T8, T15, and T20 depth gauges

Screw selection

To verify a screw's length, use the screw measurement scale found on the screw rack. The screw tip is placed with its tip against the back stop and its length can be read off the scale (Fig. 3).



WARNING

Always check the correct position and length of the inserted screws by fluoroscopy.

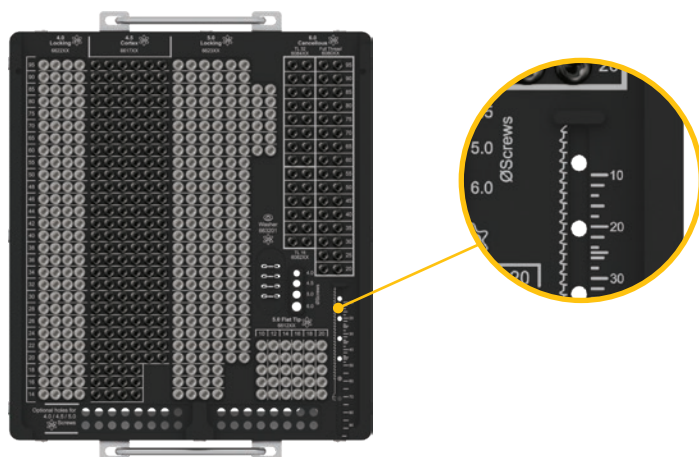

Fig. 3: Screw rack with screw measurement scale

Note: The T8 and T15 depth gauges are color-coded purple and yellow, respectively. The T20 depth gauge is not color-coded and is intended to be used for all T20 screws.

Screw capture sleeve

Pangea offers T8, T15, and T20 screw capture sleeves. The screw capture sleeves are optional devices available to offer efficient screw pick-up, insertion, and removal.

First, the T8, T15, or T20 long screwdriver shaft is inserted into its respective screw capture sleeve. Next, the screw is loaded onto the screwdriver shaft and the knob on the screw capture sleeve is depressed to capture the screw head. Once the screw is captured by the inner sleeve, the knob may be released and the screw is successfully captured. The screw may now be inserted into the pilot hole. Lastly, the screw is released by depressing the button on the end of the device prior to final tightening (Fig. 1).

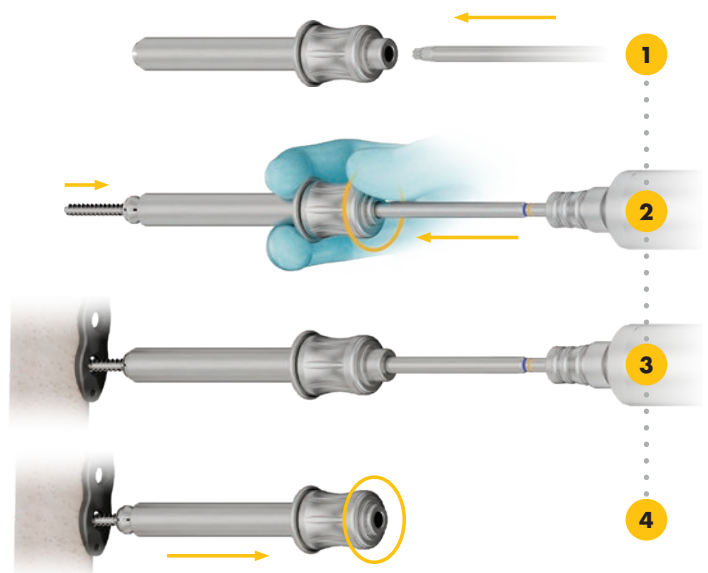

Fig. 1: Screw capture sleeve assembly

Countersinks and Taps

Countersinks are available for all screws sizes to reduce screw head prominence when the screw is used independently from a plate (Fig. 2).

Taps are available for all screw types and diameters. All screws are self-tapping; however, when inserting a screw in hard bone, it is recommended to use the appropriate tap prior to screw insertion (Fig. 3).



Fig. 2: Countersink



Fig. 3: Tap

Temporary plate fixator

Temporary plate fixators may be used as a provisional plate fixation device and should be limited to the shaft holes of the plate. The temporary plate fixator functions by pushing the shaft of the plate to the bone. The temporary plate fixator is designed with a self-drilling, self-tapping tip for quick insertion into cortical bone (Fig. 4).



Fig. 4: Temporary plate fixator

Small fragment reduction instruments and retractors

These instruments facilitate fracture reduction and soft tissue management.



Periosteal elevator, round edge (705294)

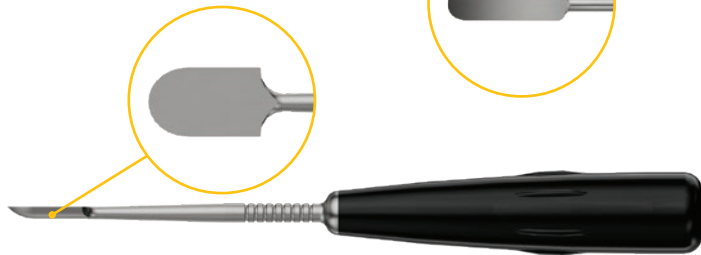

Periosteal elevator, flat edge (705295)



Sharp hook (700151)



Straight reduction clamp (705297)



Lobster claw (702932)



Ball spike (700153)



Hohmann retractor 6mm (700664)



Hohmann retractor 15mm (700667)

Large fragment reduction instruments and retractors

These instruments facilitate fracture reduction and soft tissue management.



T-handle large, AO coupling (700367)



Repositioning forceps, 205mm (702927)

Reduction forceps with serrated jaws (702940)



Reduction pin, 5.0mm (390083/390084)



Sharp hook (700151)



Ball spike (700153)

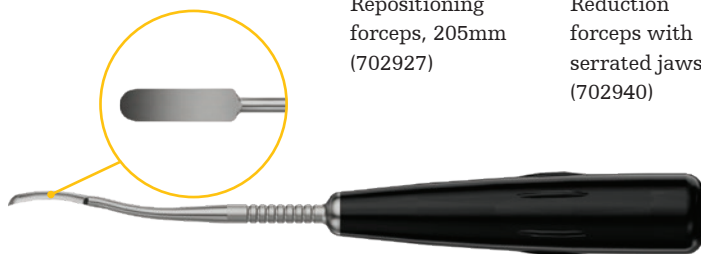

Periosteal elevator, round edge (705294)

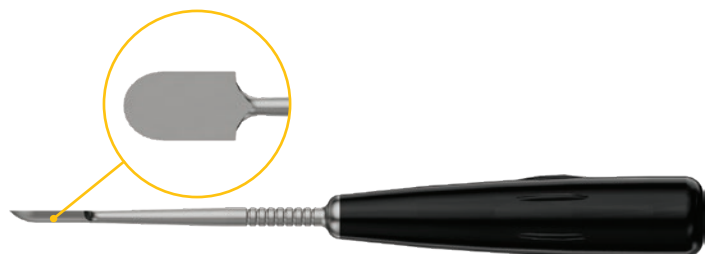

Periosteal elevator, flat edge (705295)

Note: Large fragment reduction instruments are contained in an optional large fragment reduction insert tray and may not be available in all markets. Check with your local Stryker sales representative.

Bending instruments and plate cutters

These instruments are available to aid in plate bending and plate cutting. Please refer to the table for the bending and cutting specifics of each instrument.

⚠ WARNING

Repetitively bending or rebending the plates may lead to early fatigue failure or inability to lock at a screw hole. Bending the plate at the screw hole risks compromising the locking mechanism.

⚠ WARNING

In most cases the precontoured plate will fit without the need for further bending. However, should additional out of plane bending of the plate be required, refer to the following table for bending devices and respective plate sizes.

Device Type	2.7 plates	3.5 plates	5.0 plates
Plate bender	✓		
Bending irons	✓	✓ *	
Plate cutter	✓		
Table plate bender		✓	✓

*Bending irons cannot be used to bend the following 3.5 plates: straight broad, extra articular distal humerus, proximal lateral tibia, or distal medial femur

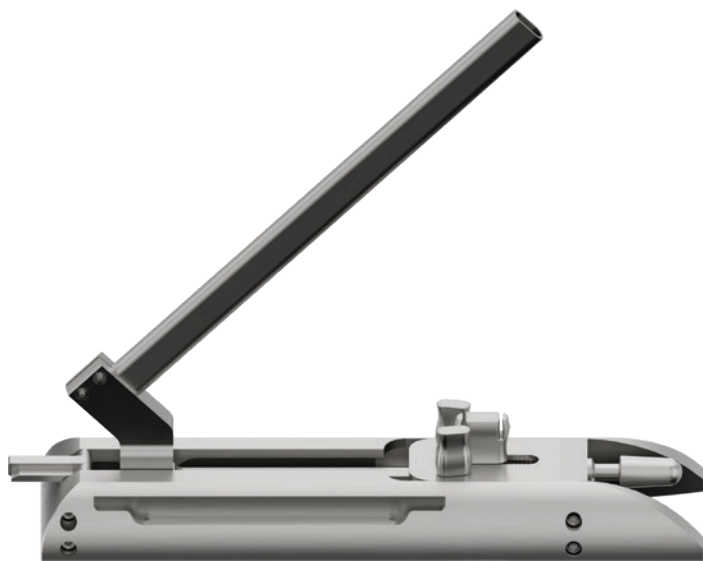

Fig. 3: Table Plate Bender

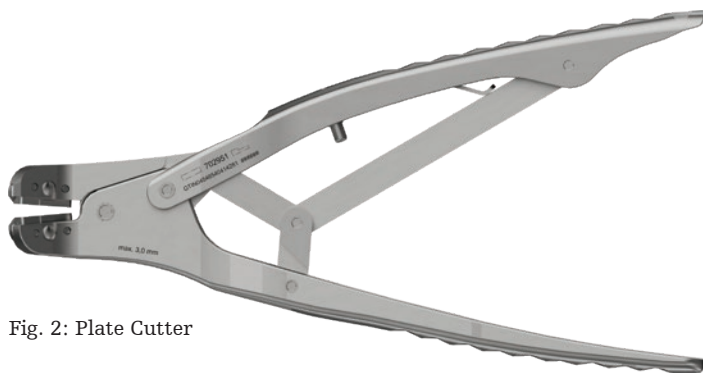

Fig. 2: Plate Cutter



Fig. 1: Bending Iron



Fig. 4: Plate Bender

Section 02

System Overview

Pangea Humerus Plating System

Distal Humerus

Required trays

ORIF extra articular distal humerus

This page details the required tray and sterile implants to use the Pangea Extra Articular Distal Humerus Plates.

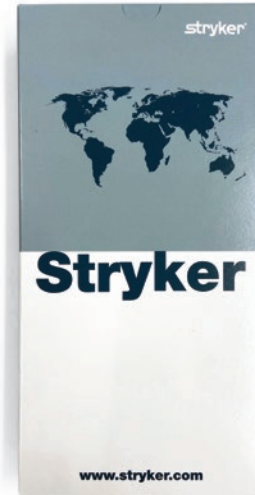
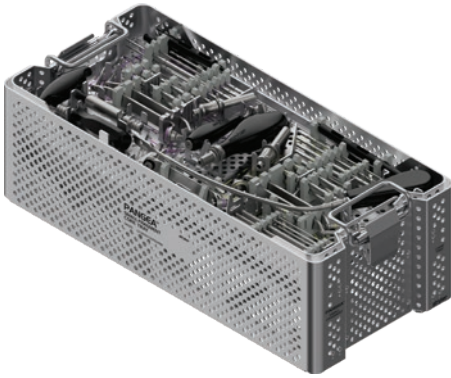

Pangea Small Fragment Core Tray



Pangea Extra Articular Distal Humerus Plates (sterile packed only)



Extra Articular Distal Humerus Plate

Implants - Plates

T15 Extra Articular Distal Humerus Plates130mm
4 Holes*164mm
6 Holes*198mm
8 Holes*232mm
10 Holes*266mm
12 Holes*300mm
14 Holes*

* Available sterile packed only

Screw offering

T15 Implants - Screws

The following screws are suitable for use with the Pangea Humerus Plating System:



Description	Ø3.5mm cortex	Ø4.0mm cancellous Partially threaded (Variable thread length)	Ø4.0mm cancellous Fully threaded	Ø3.5mm locking
Length (increments)	10-120mm 10-50mm (2mm) 50-120mm (5mm)	10-100mm 10-50mm (2mm) 50-100mm (5mm)	10-100mm 10-50mm (2mm) 50-100mm (5mm)	10-120mm 10-50mm (2mm) 50-120mm (5mm)
Material	Titanium alloy (Ti6Al4V ELI)			Cobalt-chrome alloy (CoCr)
Locking torque	N/A			4Nm
Washer	Washer T15 (663001)			N/A
Screwdriver interface	 Screwdriver bit, AO, T15 short, 93mm (542031) Screwdriver bit, AO, T15 long, 180mm (542032)			
Angulation	+/-15° (30° cone)			
Pilot drill Ø	Ø2.5mm			
Drill bits	Ø2.5mm x 135mm (542020) Ø2.5mm x 215mm (542021)			
Taps	Tap, locking, Ø3.5mm x 125mm (542023) Tap, cortex, Ø3.5mm x 125mm (702802) Tap, cancellous, Ø4mm x 125mm (702803)			



The Pangea cable plug (ref 541400S for 3.5mm plates) helps ensure positioning of a cerclage cable (Dall-Miles cable system) on the plate and can prevent slipping in oblique cable applications. These are available sterile only.

Note: Yellow represents the color code for the T15 screws. Ensure the drill guides, drills, screwdrivers, and depth gauges correspond to the yellow color code.

Extra Articular Distal Humerus Plate

- 5 distal T15 universal holes
- Increased plate thickness allowing for single column plating
- T15 Hybrid LC Holes for 2mm of compression
- 2.0mm K-wire holes
- Distal 2.0mm K-wire hole serves as a reference hole and its trajectory should bisect the capitellum
- Rounded ends designed for insertion under soft tissue

Screw options

- T15** T15 – 3.5mm locking and cortex screws and 4.0mm cancellous screws.

Variable angle locking technology

Universal holes that accept both locking and non-locking screws within a 30° cone.

SOMA designed

These plates are designed using Stryker Orthopedics Modeling and Analytics (SOMA) software.¹

- Evidence-based screw hole placement designed to offer a wide range of trajectory options for particular anatomy¹
- Anatomical fit, creating contoured plates with left and right specific options¹



Section 03

Surgical Protocol

Pangea Humerus Plating System

Distal Humerus

Plate sizes and laser markings

Selecting the appropriate plate length involves considerations including bone quality, fracture configuration and location, and the type of bone healing expected.

The plate's reference number and left/right orientation is written on the distal end of the plate. Additionally, the number of plate holes, reference number, left/right orientation, and plate length are written on the implant tray.

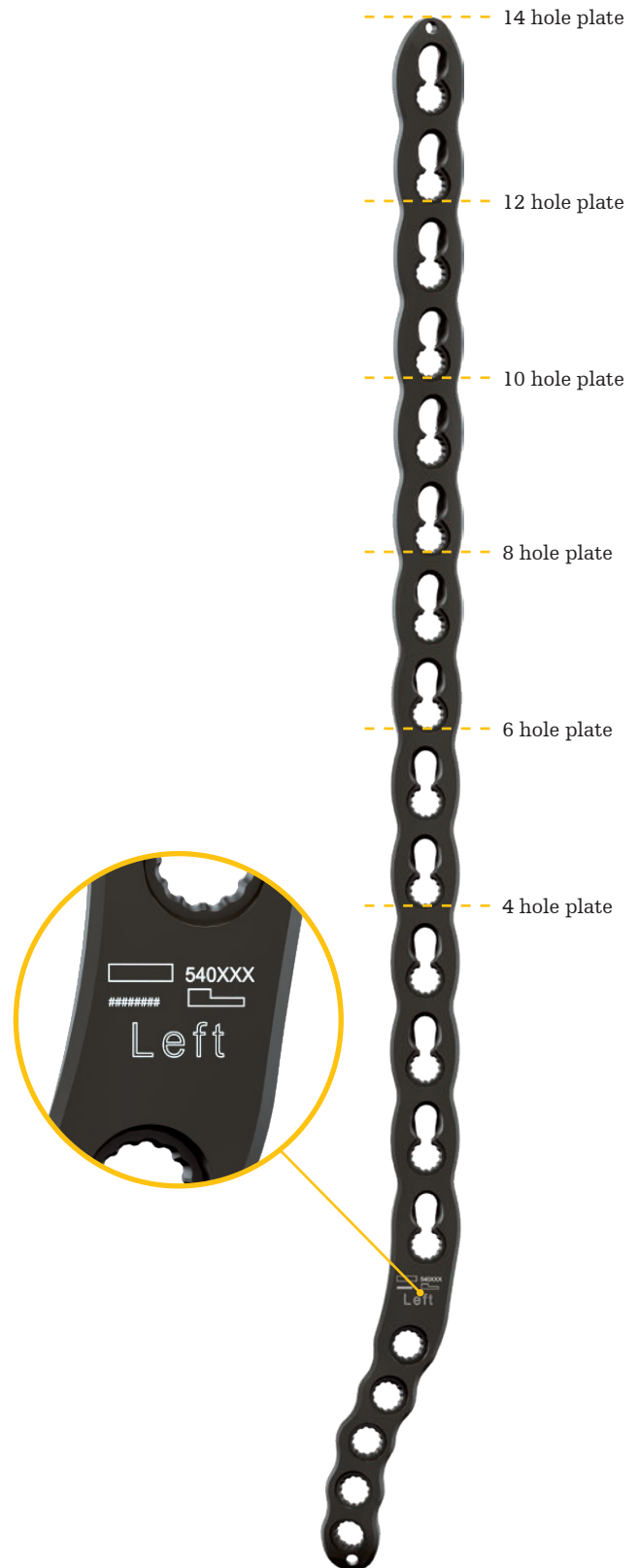

Extra Articular Distal Humerus Plate

Preoperative planning

Digital templates

The use of digital templates in association with adequate X-ray/ fluoroscopy or CT scans may assist in the selection of an appropriately sized implant. Pangea digital templates are licensed to template service providers e.g., PeekMed, Sectra AB, Lexi, and Merge Healthcare. Template service providers provide software tools and access to 3D models in order to allow surgeons to perform preoperative planning.

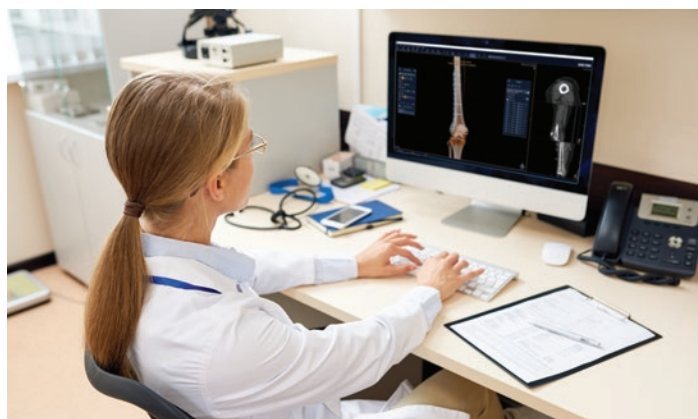

Preoperative planning using 3D planning software

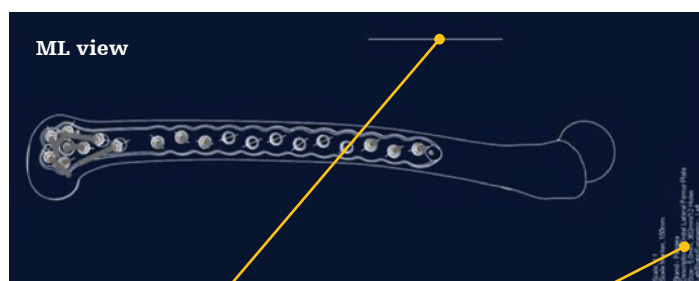
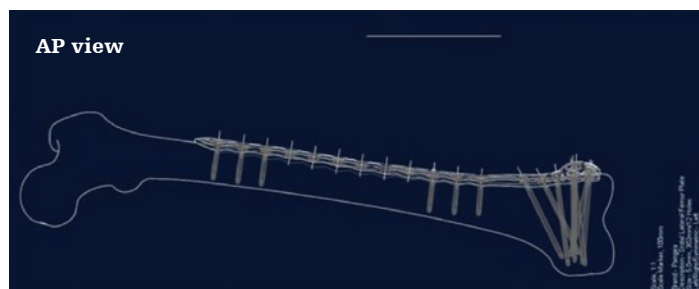

Scale marker

Details: Scale, marker, and product description

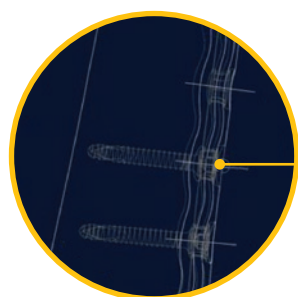

Rotational marker

Example of 2D femur templates using ".dxf" files

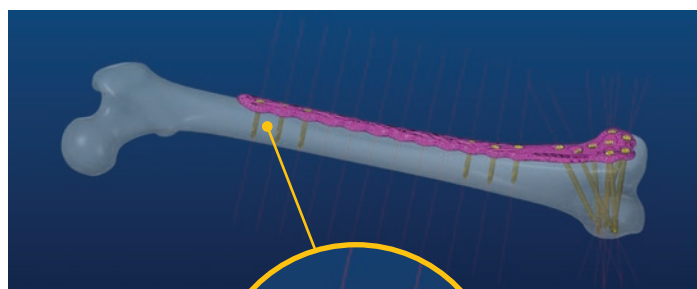

3D scanned bone model

".stl" plate model

".igs" axis data

".stl" screw model

Example of 3D femur templates using ".stl" and ".igs" files

NOTICE

If digital X-ray images are used, correct magnification has to be verified prior to use.

Note: Digital templates may also be accessed by contacting your local Stryker sales representative.

Surgical approaches

The approaches described below are common approaches for the insertion of the selected Pangea extra articular distal humerus plate. These plates can be inserted through a variety of approaches based on surgeon preference, soft tissue, and fracture characteristics.

Distal humerus

Surgeons may use a standard posterior paratricepital approach to the distal 1/3 of the humerus (Fig. 1). Depending on the fracture pattern, a surgeon may use a triceps splitting approach.

⚠ WARNING

It is recommended to explore and protect the ulnar nerve. In case of proximal extension of the fracture in the humerus shaft, exploration of the radial nerve may be necessary as well to avoid nerve damage.

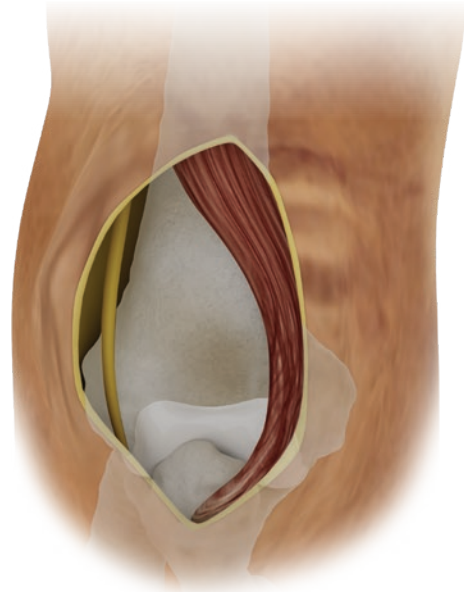

Fig. 1: Paratricepital approach to the distal humerus

Periosteal elevators

The soft tissue elevators can be utilized to separate or lift the soft tissues from the bone (Fig. 2). The curved soft tissue elevator is designed to create a pathway for the plate and is calibrated allowing the surgeon to monitor depth or measure plate length (Fig. 3).

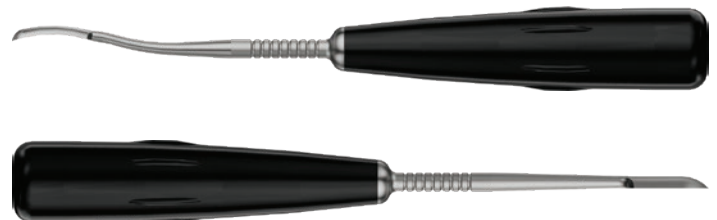

Fig. 2: Periosteal elevators

Part #	Instrumentation
542035	Curved soft tissue elevator, T15
705294	Periosteal elevator, round edge 6mm
705295	Periosteal elevator, straight edge 13mm

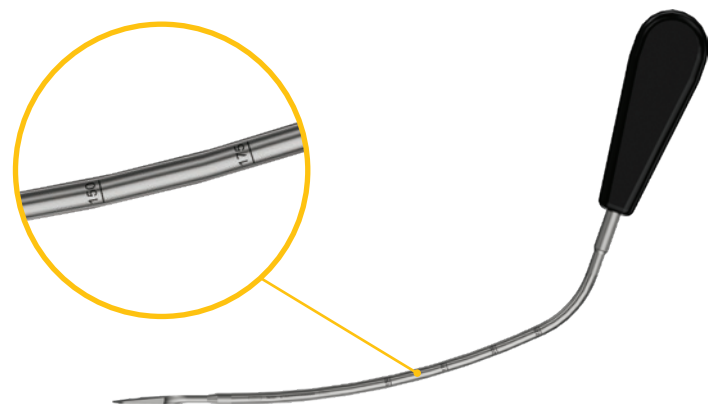

Fig. 3: Curved soft tissue elevator, T15

Reduction

Indirect fracture fragment reduction can be achieved through traction, manipulation, external fixation, or the surgeon's preferred technique. Direct fragment reduction can be achieved using elevators, clamps, or K-wires. Anatomic reduction of the fracture can be achieved through direct visualization and use of clamps.

The use of K-wires may be helpful in maintaining provisional reduction (Fig. 1). Independent lag screws may definitively stabilize articular reduction prior to plate insertion.

Plate contouring

Should bending of the plate be required, the tabletop plate bender (ref 702900) should be used (Fig. 2). To bend the distal portion of the plate only, the bending irons (ref 703938) may be used. The slots allow the device to slide over the distal tip of the plate for ease of bending (Fig. 3). Bending Irons will not fit over the shaft of the extra articular distal humerus plate.



Fig. 1: Reduction of distal humerus

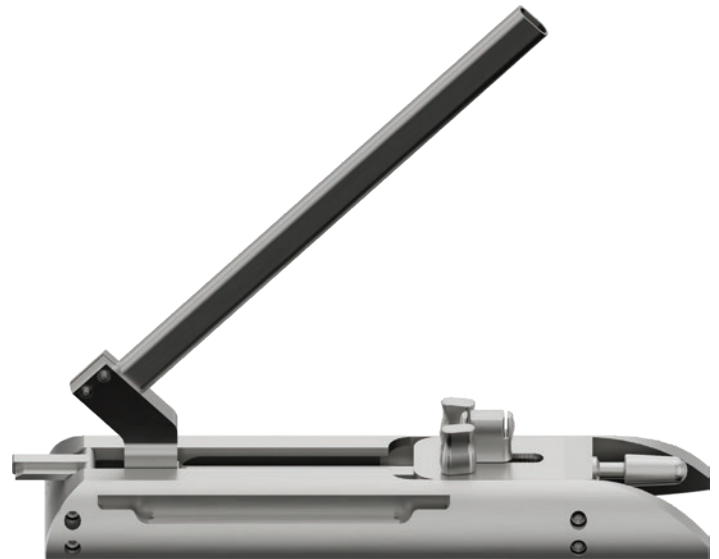

Fig. 2: Tabletop Bender



Fig. 3: Bending Irons

Plate insertion

When a plate insertion handle is desired, the surgeon may use the T15 fixed angle sleeve assembly. The T15 fixed angle sleeve assembly may be attached to any of the plate's universal holes (Fig. 1).

Using the T15 fixed angle sleeve assembly, the surgeon may insert the Extra Articular Distal Humerus Plate submuscularly (Fig. 2). Once the plate has been inserted, the surgeon may use the plate insertion handle as a joystick to adjust plate positioning (Fig.3).

Assembly instructions of the fixed angle sleeve and drill sleeve insert can be found on page 11.

Plate positioning

The extra articular distal humerus plate is designed to be applied on the lateral column using a posterior paratriciceptal approach where the triceps is mobilized but not split. Depending on fracture pattern, surgeon may use a triceps splitting approach.

Once fracture reduction is achieved and verified by fluoroscopy, the distal portion of the plate should be placed lateral to the trochlea on the posterior aspect of the distal humerus and lateral to the olecranon fossa to prevent impingement with the olecranon. The plate should be placed proximal to the joint surface to prevent impingement with the radial head with the elbow in full extension. This can be checked intra-operatively following provisional plate fixation.

The distal 2.0mm K-wire hole serves as a reference hole. The plate is in proper position when the trajectory of the K-wire bisects the capitellum (Fig. 4).

CAUTION

Avoid plate insertion through the muscle to prevent intramuscular vessel disruption. Minimize periosteal disruption while inserting the plate to help preserve bone blood supply.



Fig. 1: T15 fixed angle sleeve assembly used as a plate insertion handle or joystick

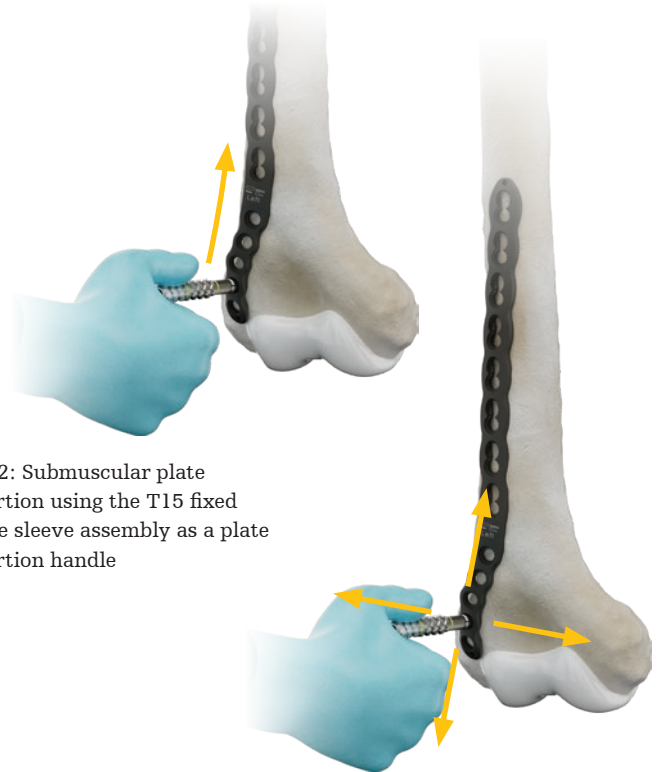

Fig. 2: Submuscular plate insertion using the T15 fixed angle sleeve assembly as a plate insertion handle

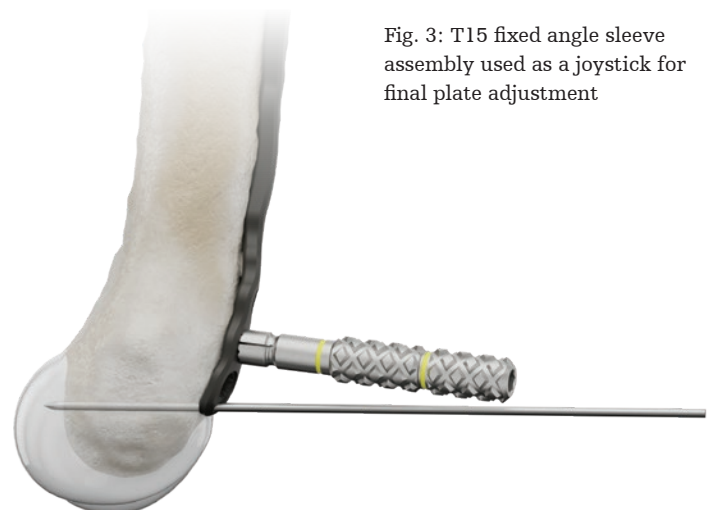

Fig. 3: T15 fixed angle sleeve assembly used as a joystick for final plate adjustment

Fig. 4: 2.0mm K-wire bisecting the capitellum to gauge plate position

Provisional plate fixation

Provisional plate fixation may be achieved in various ways:

- Ø1.6mm olive K-wire can be placed in any of the holes
- Ø2.0mm K-wire placed through the K-wire holes
- Ø2.0mm K-wire placed through the T15 fixed angle sleeve and drill sleeve insert
- Temporary plate fixator

CAUTION

Be careful when using sharp instruments such as drills, taps, K-wires and temporary plate fixators or when inserting screws to avoid damage to the soft tissue or vessels by going too far past the far cortex.

The temporary plate fixator is designed to provide provisional fixation and can be used to push the shaft of the plate to the bone (Fig. 2). There is a self-drilling, self-tapping tip for quick insertion into cortical bone. Bicortical purchase should be confirmed with fluoroscopy.

In order to protect surrounding soft tissues during pin insertion, the temporary plate fixator sleeve must be preassembled onto the temporary plate fixator pin with the self-drilling tip of the pin being flush with the tip of the sleeve (Fig. 3).

Once the device is inserted through the far cortex (Fig. 4), the threaded outer sleeve resting on the plate is turned clockwise until the desired plate position is achieved (Fig. 5).

If replacing the temporary plate fixator with definitive screw fixation is required, the surgeon must re-drill the hole using the appropriate drill and drill guide. This ensures that the pilot hole for the screw is the proper diameter and within the 30° cone.

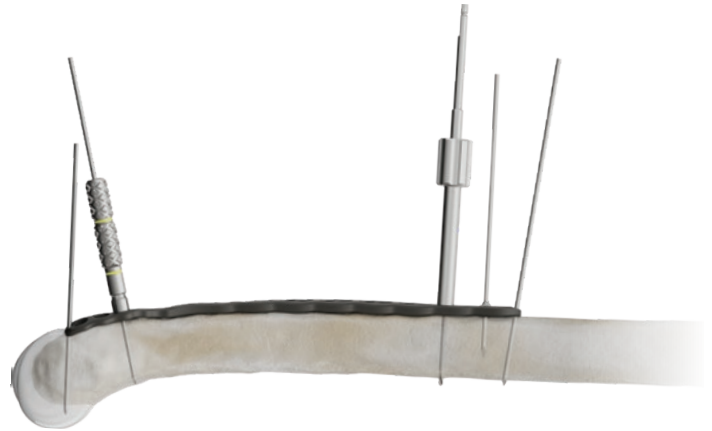

Fig. 1: Provisional fixation of Extra Articular Distal Humerus Plate

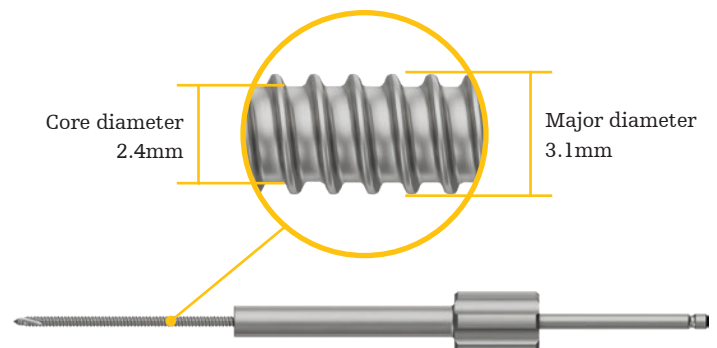
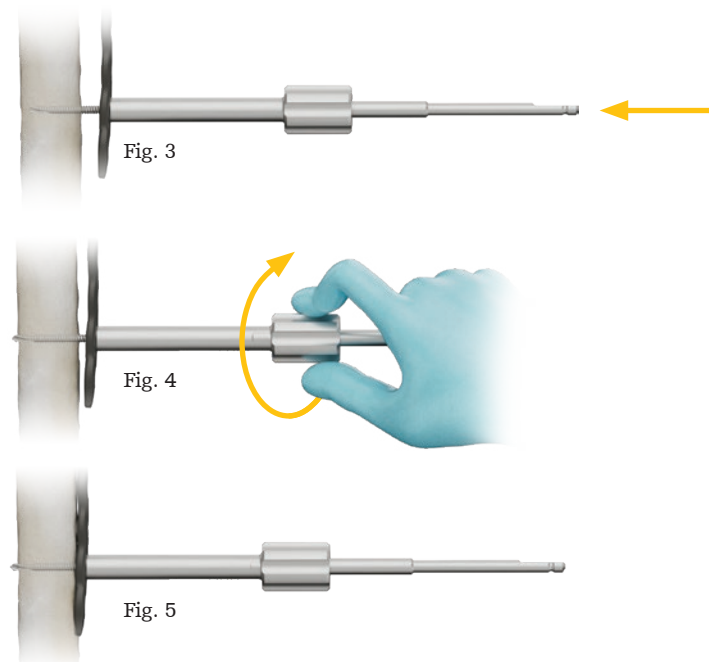

Fig. 2: Temporary plate fixator



Non-locking screw insertion

Insertion of a non-locking screw is started with the insertion of the appropriate drill guide for the screw hole.

To achieve the predetermined trajectory of the universal holes, use the T15 fixed angle sleeve with its respective drill sleeve insert (Fig. 1). Assembly instructions of the fixed angle sleeve and drill sleeve insert can be found on page 11. If a variable angle trajectory is desired, use the T15 variable angle drill guide (Fig. 2).

Next, using the 2.5mm drill bit, create a pilot hole by drilling through the selected drill guide (Fig. 3). The drill trajectory may be verified under fluoroscopy if required.

The depth may be measured utilizing the T15 depth gauge or the drill bit calibrations. The selected screw is then inserted into the pilot hole using the T15 screwdriver bit (Fig. 4).

The T15 screw capture sleeve may be used to aid in retention between the screw and screwdriver shaft during screw insertion.

CAUTION

Use bi-cortical fixation when possible.

CAUTION

If excessive resistance is felt during insertion, or if the bone is dense, it is recommended to use a tap.

CAUTION

It is recommended to insert the screws by hand. If power tools are used, use those at low speed to avoid improper alignment.

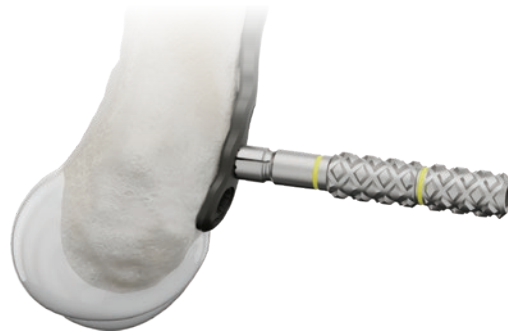

Fig. 1: T15 fixed angle sleeve assembly for predetermined screw trajectory

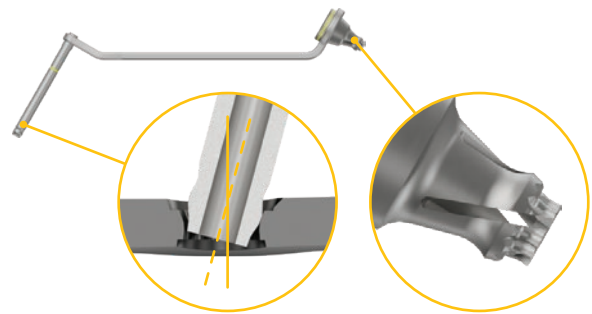

Fig. 2: Variable angle drill guide for variable angle drilling

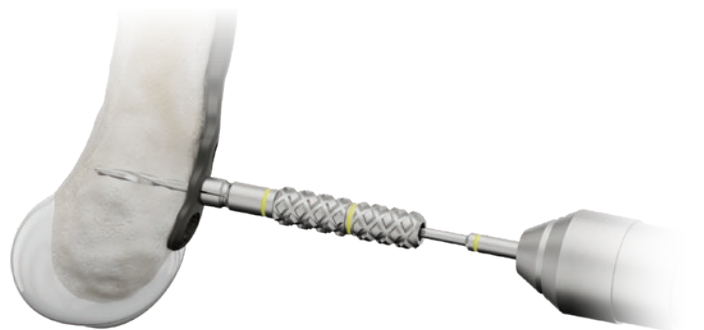

Fig. 3: Drill pilot hole with 2.5mm drill bit

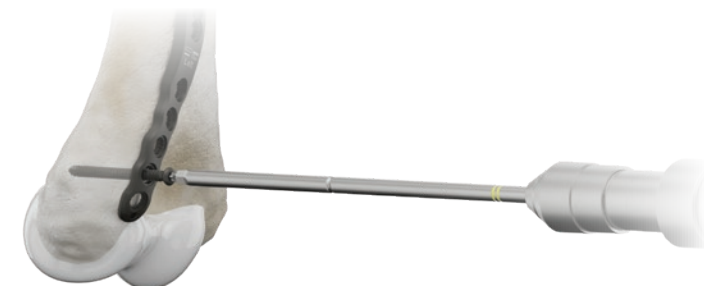

Fig. 4: Screw placement with T15 screwdriver

Locking screw insertion

Locking screws can be placed within a 30° cone in any universal screw hole.

Uni-cortical fixation is recommended when bi-cortical fixation cannot be achieved safely. For example, when bi-cortical fixation will cause screw penetration into the articular surface. In situations of uni-cortical screws, an increased screw count may be needed to obtain sufficient fixation.

To achieve the predetermined trajectory of the universal holes, use the T15 fixed angle sleeve with its respective drill sleeve insert (Fig. 1). Assembly instructions of the fixed angle sleeve and drill sleeve insert can be found on page 11. If a variable angle trajectory is desired, use the T15 variable angle drill guide (Fig. 2).

Next, using the 2.5mm drill bit, create a pilot hole by drilling through the selected drill guide. The drill trajectory may be verified with fluoroscopy if required (Fig. 3).

The depth may be measured utilizing either the T15 depth gauge or the drill bit calibrations. The selected screw is then inserted into the pilot hole using the T15 screwdriver bit.

The T15 screw capture sleeve may be used to aid in retention between the screw and screwdriver shaft during screw insertion.

Use the 4Nm torque limiting T-handle and T15 screwdriver bit to ensure proper seating of the locking screw. The torque limiter will produce an audible “click” when the required torque is achieved (Fig. 4).

WARNING

Always perform final tightening by hand using the appropriate torque limiter and screwdriver bit as final tightening with the power tool can cause over-torquing or damage to the screw-plate interface, which can lead to breaking or stripping screw heads.

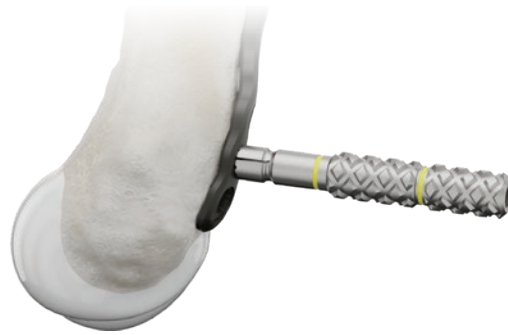

Fig. 1: T15 fixed angle sleeve assembly for predetermined screw trajectory

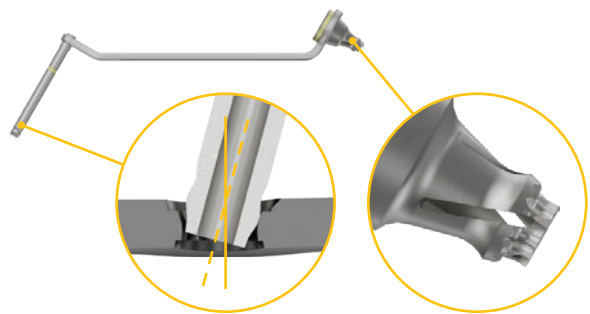

Fig. 2: Variable angle drill guide for variable angle drilling

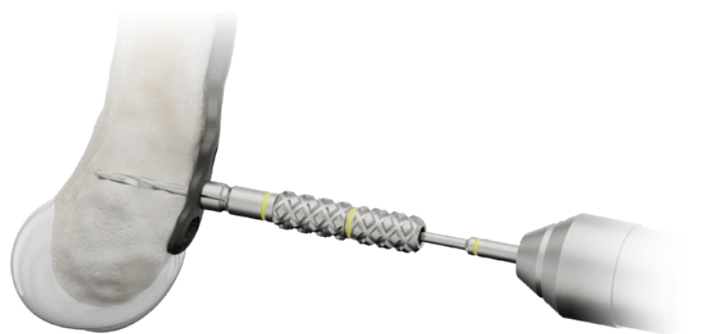

Fig. 3: Drill pilot hole with 2.5mm drill bit

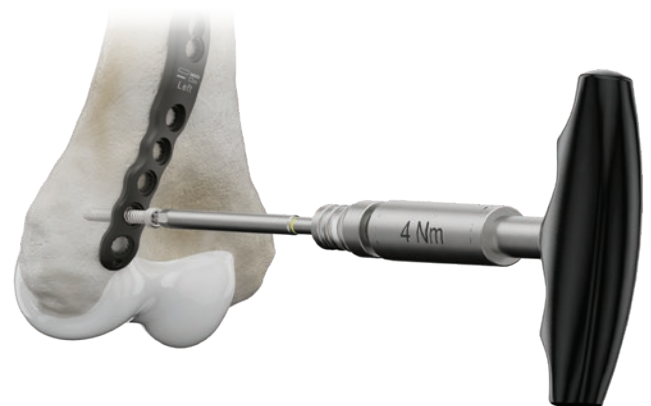

Fig. 4: Screw placement with 4.0Nm torque limiter

Lag screw technique

Independent lag screw

To insert an independent lag screw, select the appropriate lag screw drill guide for the desired lag screw size. Then use the serrated end of the guide and the appropriate overdrill to drill the near cortex (Step 1a).

Next, insert the self-centering end of the lag screw drill guide into the gliding hole and use the appropriate pilot drill to drill through the far cortex (Step 2a).

Measure the depth of the hole using the pilot drill or appropriate depth gauge and insert the selected cortex screw. If required, countersink the gliding hole or apply a washer to the screw. Upon screw insertion, this technique will serve to lag the far cortex towards the near cortex, thus applying compression (Step 3a).

Lag screw through plate

To insert a lag screw through a plate hole, use the serrated end of the appropriate lag screw drill guide and its respective overdrill to drill the near cortex through the plate hole (Step 1b).

Next, drill the far cortex with the appropriate size pilot drill by placing either the variable angle drill guide into the plate hole or the self-centering end of the lag screw drill guide into the gliding hole through the plate. When drilling the far cortex using a variable angle drill guide, ensure the trajectory of the pilot drill is co-linear with the gliding hole (Step 2b).

Measure the depth of the hole using the pilot drill or appropriate depth gauge and insert the selected cortex screw. Upon screw insertion, this technique will serve to lag the far cortex towards the near cortex, thus applying compression through the plate. Screw holes in the plate may be populated to complete the construct (Step 3b).

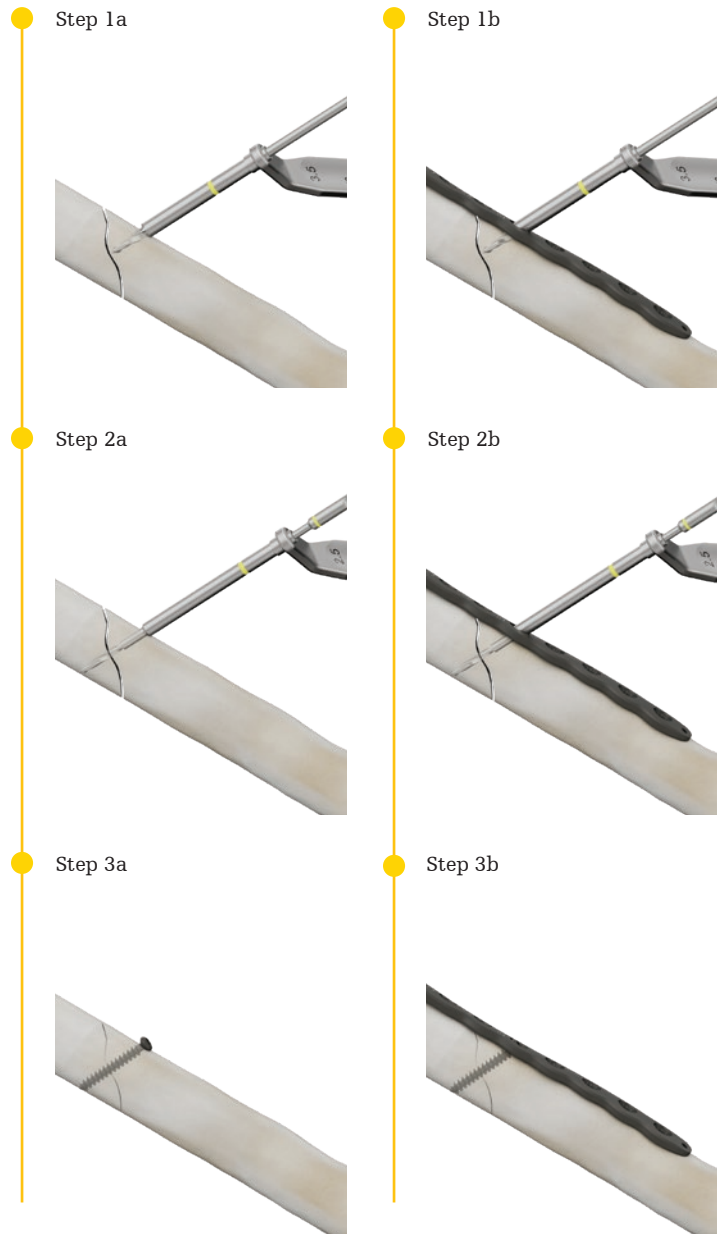

Compression technique

Once the plate is fixated distally, choose a Hybrid LC Hole on the proximal side of the fracture to obtain compression (Fig. 1). The chosen hole is normally the one closest to the fracture.

Use the T15 compression drill guide and 2.5mm pilot drill to drill a hole in the compression section of the Hybrid LC Hole. The arrow etched onto the compression drill guide barrel must be aiming toward the fracture line to correctly drill the hole eccentrically (Fig. 2).

Measure the screw depth and begin to insert the non-locking screw until fully seated. Prior to final tightening of the screw, remove any provisional plate fixation distally to allow for sliding of the plate in relation to the bone. Then firmly tighten the screw. The maximum shift per compression hole is approximately 2mm (Fig. 3).

After compression is achieved, any additional screws are to be inserted in the neutral position (Fig. 4).

Instrumentation

542009	Compression drill guide, T8 / T15, Ø2.0mm / Ø2.5mm
--------	--

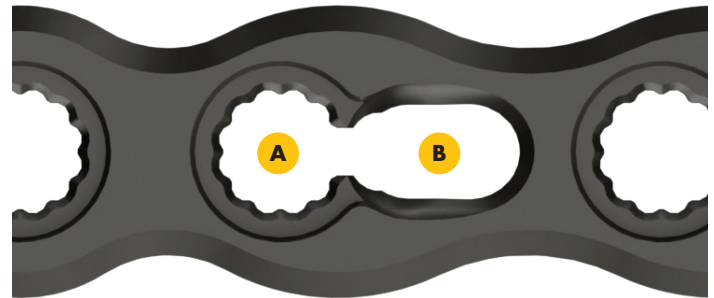

- A:** Universal: For locking or non-locking screws
- B:** Compression: For non-locking screws only

Hybrid LC Hole

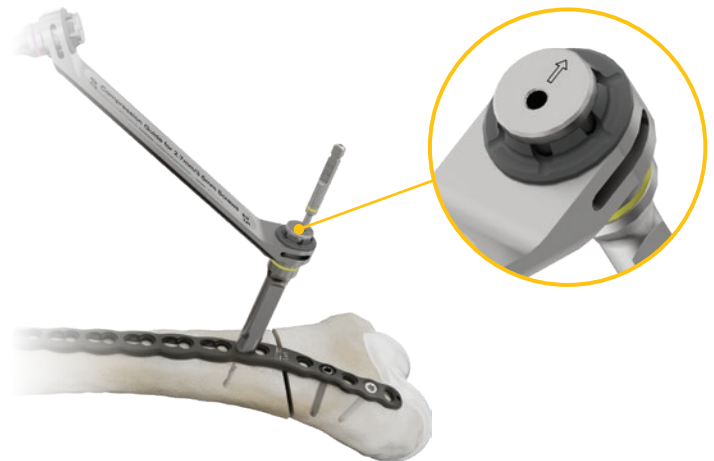

Fig. 2: To achieve compression, the arrow must point towards the fracture site



Fig. 3: Placement of non-locking screw providing compression



Fig. 4: Additional screws are populated

Note: If further compression is required, another compression screw may be used on the initial neutral side of the fracture provided that the initial neutral screw is removed from the plate before seating the additional compression screw.

Cables and cable plugs

Cable plug insertion

In any universal hole, cable plugs can be utilized in conjunction with Ø2.0mm vitallium cables from the Dall-Miles cable system.

The use of a cable plug helps to ensure positioning of a cerclage cable (Dall-Miles cable system) on the plate and can prevent slipping in oblique cable applications. These are only available in sterile packaging.

Insert a cable plug by “clicking” it into the desired screw hole and confirming its placement through an audible “click”. The cable plug is still able to freely rotate after proper placement in the universal hole.

Insert a cable through the eyelet of the cable plug, tighten the cable, and crimp the sleeve. Cut the cable near the crimped sleeve.

For complete instructions, refer to the Dall-Miles cabling system operative technique (DALLM-SP-1_21060).

Ref #	Instrumentation
541400S	3.5mm cable plug
6704-0-520	Ø2.0mm Vitallium beaded cable / sleeve set
6704-9-320	Single sided tensioner
6704-9-150	Crimp tool
6704-9-420	Cable cutter

Cable plug removal

If a cable plug has to be removed, simply cut or remove the cable and pull out the cable plug using forceps. The cable plug can be re-seated up to 3 times intraoperatively.

WARNING

When placing cable around the humerus, ensure radial nerve is not entrapped.

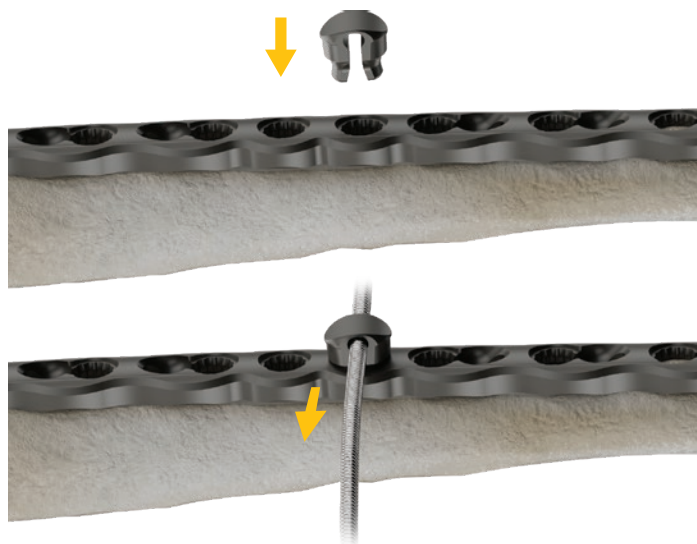

CAUTION

Do not exceed plate/cable plug relative angulation of 35° from the screw hole axis for universal holes and 25° from the screw hole axis for hybrid holes.



Final fluoroscopic check

After final fixation of the plate with all screws, the distal humerus is internally and externally rotated under continuous fluoroscopy; the true distance of all screws should be inspected in the AP, and lateral views to ensure none of the screws have penetrated the joint or are prominent.



WARNING

After the procedure, check that all implants are positioned correctly using an image intensifier.

Implant removal

Removal of the Pangea Humerus Plates is not required in general. The additional surgical trauma and the risks associated with additional anesthesia should be individually outweighed against the potential benefits for every patient.

In the case of implant removal, the scar of the previous incision is (partly) re-opened and the screws and the plate are successively removed.

Extra Articular Distal Humerus Plate

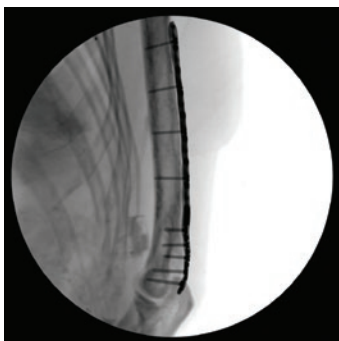
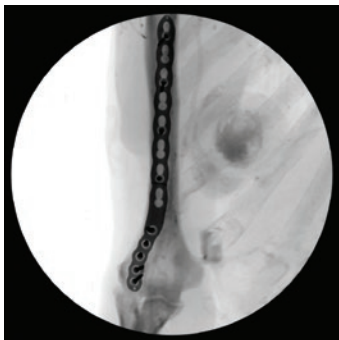

Predetermined trajectory



Screws in the predetermined screw trajectory

Variable angle trajectory

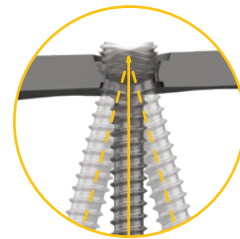

Screw trajectories using variable angle locking to obtain the widest allowable screw trajectory

NOTICE

In the extreme event of broken or stripped screws, the Stryker implant extraction set (literature number IES-ST-1) includes a variety of broken screw removal instruments.

Packaging details

The sterile extra articular distal humerus plates are packaged in a double peel pouch sterile barrier system, which is further protected by a cushion bag, a cardboard inlay and a box.

After the double peel pouch sterile barrier system is removed from the cushion bag, the outer pouch is peeled open to access the inner pouch, which is introduced in the sterile field.

The inner pouch is then peeled open allowing safe access to the sterile implant.



Step 1: Sterile packed extra articular distal humerus plate



Step 2: Image of the box being opened and the plate in the double packed peel pouch being removed



Step 3: Double packed peel pouch



Step 4: Protective bubble wrap is removed



Step 5: Image of the double packed peel pouch being opened and passed onto sterile field



Step 6: Image of inner pouch being opened by sterile gloves

Section 04

System Components

System components

The information in this section is not intended to be used for sales and/or promotional purposes. This information is solely intended to be used as a reference for clinical usage.

Extra Articular Distal Humerus Plate

Left ref #	Right ref #	Plate length	Shaft holes
540104S*	540834S*	130mm	4
540106S*	540836S*	164mm	6
540108S*	540838S*	198mm	8
540110S*	540840S*	232mm	10
540112S*	540842S*	266mm	12
540114S*	540844S*	300mm	14



*Sterile packed only

Note: All non-sterile plates and screws may be ordered sterile by placing an "S" at the end of the ref number. Sterile option availability varies by market

System components

Pangea Small Fragment Core Tray

Top level consisting of the instruments listed below:

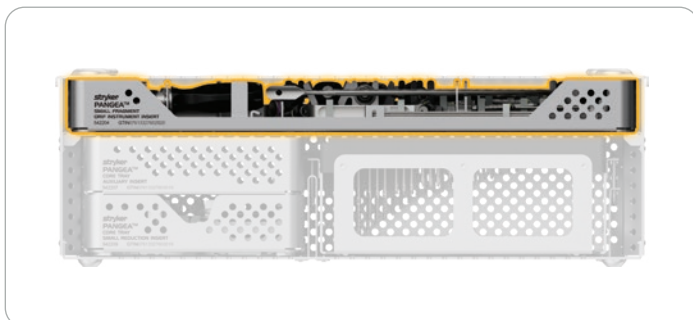

Ref #	Description
542201	Aluminum lid - universal
542203	Small fragment core tray base
542204	Small fragment ORIF instrument insert
542254	Small fragment std. torque handle insert

Pangea Small Fragment Core Tray - ORIF instrument insert

Ref #	Description
542005	Fixed angle sleeve, T8
542006	Drill sleeve insert, T8, 60mm, ø2.0mm
542008	Variable angle drill guide, T8, ø2.0mm
542009	Compression drill guide, T8 / T15, ø2.0mm / ø2.5mm
542010	Lag screw drill guide, T8, ø2.0mm / ø2.7mm
542011	Screwdriver bit, AO, T8, 93mm
542012	Screwdriver bit, AO, T8, 180mm
542016	Depth gauge, T8, 0-80mm
542015	Screw capture sleeve, T8
542017	Depth gauge, T15, 0-120mm
542025	Fixed angle sleeve, T15
542026	Drill sleeve insert, T15, 60mm, ø2.5mm
542028	Variable angle drill guide, T15, ø2.5mm
542030	Lag screw drill guide, T15, ø2.5mm / ø3.5mm
542031	Screwdriver bit, AO, T15, 93mm
542032	Screwdriver bit, AO, T15, 180mm
542035	Soft tissue elevator, T15
45-80040	Countersink for screws 2.7/3.5mm, AO fitting
542103	Threaded guide post, T15
542027	Screw capture sleeve, T15
542098	Delta handle, small, AO, T8 / T15
542099	Delta handle, large, AO, T20
542000	Drill bit, AO, Ø2.0mm x 135mm
542001	Drill bit, AO, Ø2.0mm x 175mm

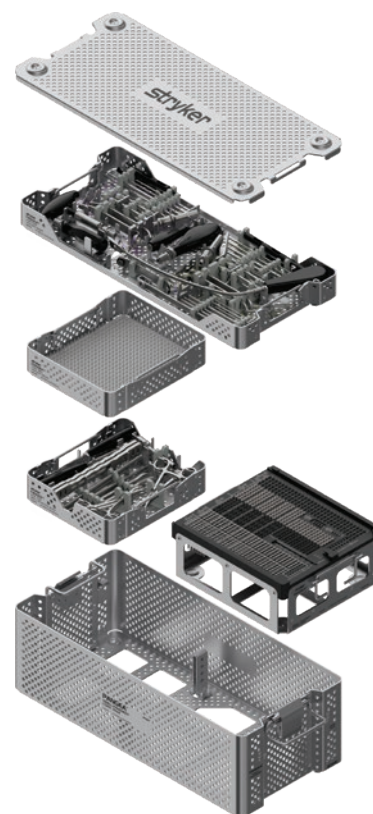

System components

Pangea Small Fragment Core Tray

Top level consisting of the instruments listed below:

Pangea Small Fragment Core Tray - ORIF instrument insert

Ref #	Description
542002	Drill bit, AO, Ø2.7mm x 125mm
542020	Drill bit, AO, Ø2.5mm x 135mm
542021	Drill bit, AO, Ø2.5mm x 215mm
542022	Drill bit, AO, Ø3.5mm x 135mm
542003	Tap, locking, AO, Ø2.7mm x 125mm
702801	Tap, AO, Ø2.7mm x 125mm
542023	Tap, locking, AO, Ø3.5mm x 125mm
702802	Tap, AO, Ø3.5mm x 125mm
702803	Tap, cancellous, Ø4mm x 125mm
705002	K-wire drill tip, Ø2.0mm x 234mm
390157	K-wire Ø1.25 x 150mm
390164	K-wire Ø1.6 x 150mm
390192	K-wire Ø2.0 x 150mm
542036	K-wire, olive tip, Ø1.6mm / 100mm

Torque limiter insert instruments

Ref #	Description
542014	Torque limiting Delta handle, AO, T8 1.7Nm
542034	Torque limiting T-handle, AO, T15 4.0Nm

System components

Pangea Small Fragment Core Tray - Instruments

Second level consisting of the instruments listed below:

This level can be removed and replaced with the optional inserts: Core tray ankle plate insert, core tray small fragment utility plate insert, or core tray Asnis III 4.0mm cannulated screw insert.



Ref #	Description
542207	Core tray auxiliary insert
542208	Silicone mat, auxiliary insert

System components

Pangea Small Fragment Core Tray - Instruments

Third level consisting of the instruments listed below:

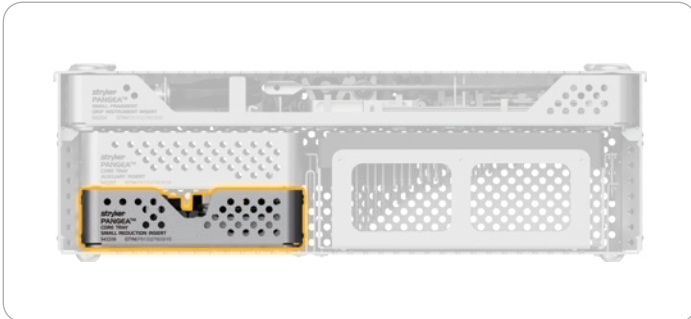

Ref #	Description
542209	Core tray small reduction insert

Pangea Small Fragment Core Tray - Core tray small reduction insert

Ref #	Description
700151	Hook
700153	Ball spike
700664	Hohmann retractor 6mm
700667	Hohmann retractor 15mm
705294	Periosteal elevator, round edge 6mm
705295	Periosteal elevator, flat blade 13mm
705297	Straight reduction clamp, broad
702932	Repositioning forceps, L143mm (lobster claw)
703938	Bending iron
705019	Temporary plate fixator, AO

System components

Pangea Small Fragment Core Tray - Optional ankle insert



Ref #	Description
542248	Core tray ankle plate insert

Implants

Ref #	Description	
540644	Distal lateral fibula plate, L	2.7/3.5mm, 81mm/4 holes
540664	Distal lateral fibula plate, R	2.7/3.5mm, 81mm/4 holes
540645	Distal lateral fibula plate, L	2.7/3.5mm, 95mm/5 holes
540665	Distal lateral fibula plate, R	2.7/3.5mm, 95mm/5 holes
540646	Distal lateral fibula plate, L	2.7/3.5mm, 109mm/6 holes
540666	Distal lateral fibula plate, R	2.7/3.5mm, 109mm/6 holes
540647	Distal lateral fibula plate, L	2.7/3.5mm, 123mm/7 holes
540667	Distal lateral fibula plate, R	2.7/3.5mm, 123mm/7 holes
540648	Distal lateral fibula plate, L	2.7/3.5mm, 137mm/8 holes
540668	Distal lateral fibula plate, R	2.7/3.5mm, 137mm/8 holes
541342	3.5 1/3 tubular plate	3.5mm, 26mm/2 holes
541343	3.5 1/3 tubular plate	3.5mm, 38mm/3 holes
541344	3.5 1/3 tubular plate	3.5mm, 50mm/4 holes
541345	3.5 1/3 tubular plate	3.5mm, 62mm/5 holes
541346	3.5 1/3 tubular plate	3.5mm, 74mm/6 holes
541347	3.5 1/3 tubular plate	3.5mm, 86mm/7 holes
541348	3.5 1/3 tubular plate	3.5mm, 98mm/8 holes
541349	3.5 1/3 tubular plate	3.5mm, 110mm/9 holes
541303	2.7 hook plate	2.7mm, 37mm/3 holes
541305	2.7 hook plate	2.7mm, 57mm/5 holes
541321	2.7 T-plate	2.7mm, 3Tx5
541331	3.5 T-plate	3.5mm, 3Tx5

For the full offering of lengths please refer to the fibula and small fragment utility plate optechs.

*Sterile packed only

Note: All non-sterile plates and screws may be ordered sterile by placing an "S" at the end of the ref number. Sterile option availability varies by market

Pangea Small Fragment Core Tray - Optional Asnis III 4.0mm cannulated screw insert

Ref #	Description
542245	Core tray Asnis III 4.0mm cannulated screw insert
940236	Screw rack Asnis III 4.0mm

Instruments

Ref #	Description
702465	Double drill guide, \varnothing 1.4mm/2.7mm
702446	Cannulated drill, AO, \varnothing 4.0mm
702449	Cannulated drill, AO, \varnothing 2.7mm
702459	Threaded guide wire, \varnothing 1.4x150mm
702454	Cannulated tap, AO, \varnothing 4.0mm
702473	Cannulated countersink, AO, \varnothing 4.0mm screws
702499	Direct measuring gauge for wires \varnothing 1.4/2.0x150mm
702482	Cannulated screwdriver, AO, hex 2.5mm
702485	Solid screwdriver, AO, hex 2.5mm
702489	Holding sleeve for screwdrivers, for screwheads \varnothing 5.0mm
702492	Cleaning stylet \varnothing 1.4mm
702496	Extractor, AO, \varnothing 4.0mm screws

Implants

Ref #	Description
604624	4.0 X 24mm TI cannulated screw
604626	4.0 X 26mm TI cannulated screw
604628	4.0 X 28mm TI cannulated screw
604630	4.0 X 30mm TI cannulated screw
604632	4.0 X 32mm TI cannulated screw
604634	4.0 X 34mm TI cannulated screw
604636	4.0 X 36mm TI cannulated screw
604638	4.0 X 38mm TI cannulated screw
604640	4.0 X 40mm TI cannulated screw
604642	4.0 X 42mm TI cannulated screw

Pangea Small Fragment Core Tray - Optional Asnis III 4.0mm cannulated screw insert**Implants**

Ref #	Description
604644	4.0 X 44mm TI cannulated screw
604646	4.0 X 46mm TI cannulated screw
604648	4.0 X 48mm TI cannulated screw
604650	4.0 X 50mm TI cannulated screw
604655	4.0 X 55mm TI cannulated screw
604660	4.0 X 60mm TI cannulated screw
604665	4.0 X 65mm TI cannulated screw
604670	4.0 X 70mm TI cannulated screw
604724	4.0 X 24mm TI cannulated screw, full thread
604726	4.0 X 26mm TI cannulated screw, full thread
604728	4.0 X 28mm TI cannulated screw, full thread
604730	4.0 X 30mm TI cannulated screw, full thread
604732	4.0 X 32mm TI cannulated screw, full thread
604734	4.0 X 34mm TI cannulated screw, full thread
604736	4.0 X 36mm TI cannulated screw, full thread
604738	4.0 X 38mm TI cannulated screw, full thread
604740	4.0 X 40mm TI cannulated screw, full thread
604742	4.0 X 42mm TI cannulated screw, full thread
604744	4.0 X 44mm TI cannulated screw, full thread
604746	4.0 X 46mm TI cannulated screw, full thread
604748	4.0 X 48mm TI cannulated screw, full thread
604750	4.0 X 50mm TI cannulated screw, full thread
619905	Washer

*Sterile packed only

Note: All non-sterile plates and screws may be ordered sterile by placing an "S" at the end of the ref number. Sterile option availability varies by market

Pangea Small Fragment Core Tray - Optional small fragment utility plate insert

Ref #	Description
542247	Core tray small utility plate insert

Implants

Ref #	Description	
541342	3.5 1/3 tubular plate	3.5mm, 26mm/2 holes
541343	3.5 1/3 tubular plate	3.5mm, 38mm/3 holes
541344	3.5 1/3 tubular plate	3.5mm, 50mm/4 holes
541345	3.5 1/3 tubular plate	3.5mm, 62mm/5 holes
541346	3.5 1/3 tubular plate	3.5mm, 74mm/6 holes
541347	3.5 1/3 tubular plate	3.5mm, 86mm/7 holes
541348	3.5 1/3 tubular plate	3.5mm, 98mm/8 holes
541349	3.5 1/3 tubular plate	3.5mm, 110mm/9 holes
541303	2.7 hook plate	2.7mm, 37mm/3 holes
541305	2.7 hook plate	2.7mm, 57mm/5 holes
541313	3.5 hook plate	3.5mm, 49mm/3 holes
541315	3.5 hook plate	3.5mm, 79mm/5 holes
541321	2.7 T-plate	2.7mm, 3TX5
541322	2.7 T-plate	2.7mm, 3TX10

Ref #	Description	
541331	3.5 T-plate	3.5mm, 3Tx5
541332	3.5 T-plate	3.5mm, 3Tx10
541036	3.5 straight narrow plate	3.5mm, 81mm/6 holes
541037	3.5 straight narrow plate	3.5mm, 104mm/7 holes
541038	3.5 straight narrow plate	3.5mm, 115mm/8 holes
541039	3.5 straight narrow plate	3.5mm, 138mm/9 holes
541040	3.5 straight narrow plate	3.5mm, 149mm/10 holes
541042	3.5 straight narrow plate	3.5mm, 183mm/12 holes
541004	2.7 straight narrow plate	2.7mm, 31mm/4 holes
541006	2.7 straight narrow plate	2.7mm, 46mm/6 holes
541008	2.7 straight narrow plate	2.7mm, 61mm/8 holes
541010	2.7 straight narrow plate	2.7mm, 76mm/10 holes
541020	2.7 straight narrow plate	2.7mm, 152mm/20 holes

For the full offering of lengths please refer to the fibula and small fragment utility plate optechs.

*Sterile packed only

Note: All non-sterile plates and screws may be ordered sterile by placing an "S" at the end of the ref number. Sterile option availability varies by market

System components

Pangea Small Fragment Core Tray - Screws

Screw rack consisting of the implants listed below:

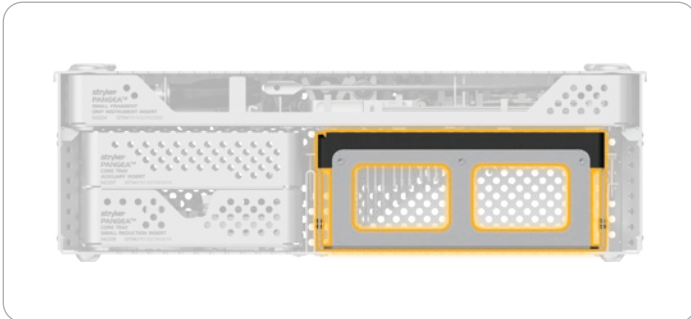

Ref #	Description
542205	Small fragment screw rack (with lid)
542206	Small fragment screw rack lid

2.7mm locking screw self-tapping, T8 drive

Ref #	Length (mm)	Ref #	Length (mm)
541408	8	541436	36
541410	10	541438	38
541412	12	541440	40
541414	14	541442	42
541416	16	541444	44
541418	18	541446	46
541420	20	541448	48
541422	22	541450	50
541424	24	541455	55
541426	26	541460	60
541428	28	541465	65
541430	30	541470	70
541432	32	541475S*	75
541434	34	541480S*	80



*Sterile packed only

Note: All non-sterile plates and screws may be ordered sterile by placing an "S" at the end of the ref number. Sterile option availability varies by market

System components

Pangea Small Fragment Core Tray - Screws

Screw rack consisting of the implants listed below:

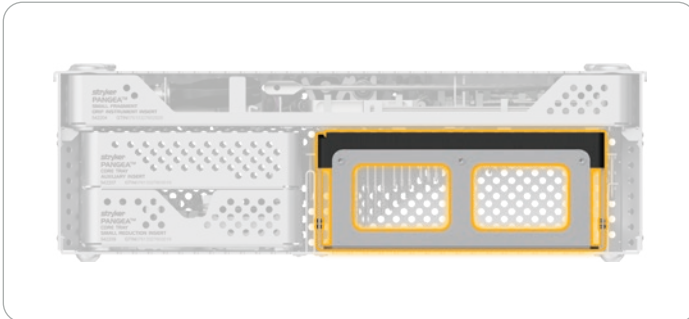

2.7mm cortex screw self-tapping, T8 drive

Ref #	Length (mm)	Ref #	Length (mm)
541708	8	541736	36
541710	10	541738	38
541712	12	541740	40
541714	14	541742	42
541716	16	541744	44
541718	18	541746	46
541720	20	541748	48
541722	22	541750	50
541724	24	541755	55
541726	26	541760	60
541728	28	541765	65
541730	30	541770	70
541732	32	541775S*	75
541734	34	541780S*	80



*Sterile packed only

Note: All non-sterile plates and screws may be ordered sterile by placing an "S" at the end of the ref number. Sterile option availability varies by market

System components

Pangea Small Fragment Core Tray - Screws

Screw rack consisting of the implants listed below:

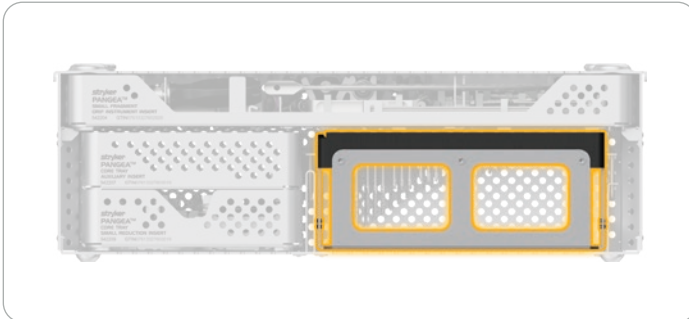

3.5mm locking screw self-tapping, T15 drive

Ref #	Length (mm)	Ref #	Length (mm)
541510	10	541546	46
541512	12	541548	48
541514	14	541550	50
541516	16	541555	55
541518	18	541560	60
541520	20	541565	65
541522	22	541570	70
541524	24	541575	75
541526	26	541580	80
541528	28	541585	85
541530	30	541590	90
541532	32	541595	95
541534	34	541600S*	100
541536	36	541605S*	105
541538	38	541610S*	110
541540	40	541615S*	115
541542	42	541620S*	120
541544	44		



*Sterile packed only

Note: All non-sterile plates and screws may be ordered sterile by placing an "S" at the end of the ref number. Sterile option availability varies by market

System components

Pangea Small Fragment Core Tray - Screws

Screw rack consisting of the implants listed below:

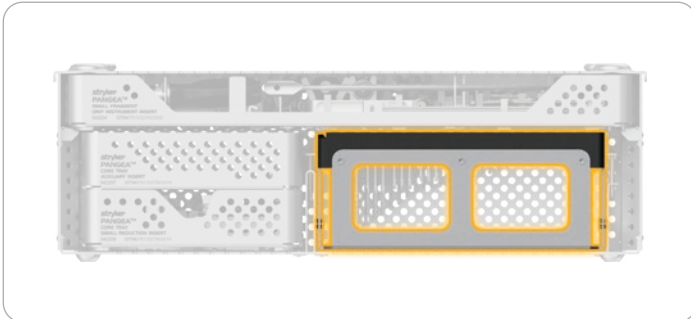

3.5mm cortex screw self-tapping, T15 drive

Ref #	Length (mm)	Ref #	Length (mm)
661410	10	661446	46
661412	12	661448	48
661414	14	661450	50
661416	16	661455	55
661418	18	661460	60
661420	20	661465	65
661422	22	661470	70
661424	24	661475	75
661426	26	661480	80
661428	28	661485	85
661430	30	661490	90
661432	32	661495	95
661434	34	661500S*	100
661436	36	661505S*	105
661438	38	661510S*	110
661440	40	661515S*	115
661442	42	661520S*	120
661444	44		



*Sterile packed only

Note: All non-sterile plates and screws may be ordered sterile by placing an "S" at the end of the ref number. Sterile option availability varies by market

System components

Pangea Small Fragment Core Tray - Screws

Screw rack consisting of the implants listed below:

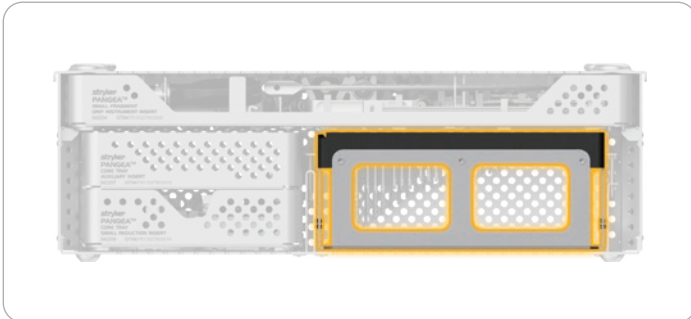

4.0mm cancellous screw full thread self-tapping, T15 drive

Ref #	Length (mm)	Ref #	Length (mm)
607310	10	607342	42
607312	12	607344	44
607314	14	607346	46
607316	16	607348	48
607318	18	607350	50
607320	20	607355	55
607322	22	607360	60
607324	24	607365	65
607326	26	607370	70
607328	28	607375	75
607330	30	607380	80
607332	32	607385	85
607334	34	607390	90
607336	36	607395	95
607338	38	607400S*	100
607340	40		



*Sterile packed only

Note: All non-sterile plates and screws may be ordered sterile by placing an "S" at the end of the ref number. Sterile option availability varies by market

System components

Pangea Small Fragment Core Tray - Screws

Screw rack consisting of the implants listed below:

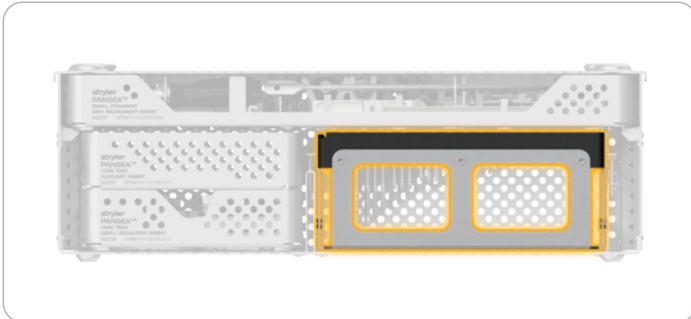

4.0mm cancellous screw partial thread self-tapping, T15 drive

Ref #	Length (mm)	Thread length (mm)	Ref #	Length (mm)	Thread length (mm)
607410	10	5	607442	42	15
607412	12	5	607444	44	15
607414	14	5	607446	46	15
607416	16	6	607448	48	15
607418	18	7	607450	50	15
607420	20	8	607455	55	16
607422	22	9	607460	60	16
607424	24	10	607465	65	16
607426	26	12	607470	70	16
607428	28	14	607475	75	16
607430	30	14	607480	80	16
607432	32	14	607485	85	16
607434	34	14	607490	90	16
607436	36	14	607495	95	16
607438	38	14	607500S*	100	16
607440	40	14			



Cable plugs and washers

Ref #	Description
541400S*	3.5mm cable plug
40-30900	Washer, T8
663001	Washer, T15



*Sterile packed only

Note: All non-sterile plates and screws may be ordered sterile by placing an "S" at the end of the ref number. Sterile option availability varies by market

System components

Pangea Large Fragment Core Tray

Top level consisting of the instruments listed below:

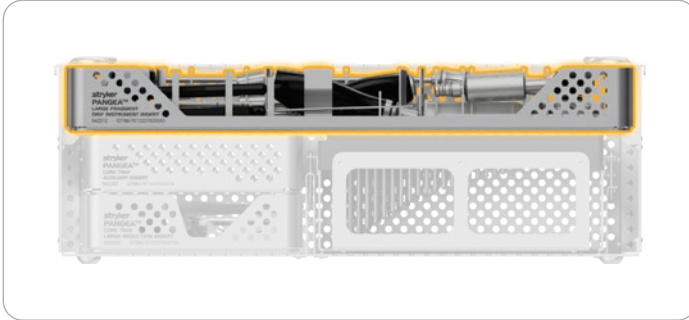

Ref #	Description
542201	Aluminum lid - universal
542211	Large fragment core tray base
542212	Large fragment ORIF instrument insert
542255	Large fragment std. torque handle insert

Pangea Large Fragment Core Tray - ORIF instrument insert

Ref #	Description
542058	Fixed angle sleeve, T20
542059	Drill sleeve insert, T20, 60mm, ø3.2mm
542060	Drill sleeve insert, T20, 60mm, ø4.3mm
542061	K-wire sleeve insert, T20, ø2.0mm
542062	Variable angle drill guide, T20, ø3.2mm
542063	Variable angle drill guide, T20, ø4.3mm
542064	Compression drill guide, T20, ø3.2mm
542065	Lag screw drill guide, T20, ø4.5mm / ø3.2mm
542066	Screwdriver bit, AO, T20, 93mm
542067	Screwdriver bit, AO, T20, 180mm
542099	Delta handle, large, AO, T20
702812	Countersink, AO, ø4.5/6.5mm
705014	Depth gauge, T20, 0-120mm
542105	Threaded guide post, T20
706416	Soft tissue elevator, T20
705019	Temporary plate fixator, AO
542069	Screw capture sleeve, T20
542050	Drill bit, AO, Ø3.2mm x 145mm
542051	Drill bit, AO, Ø3.2mm x 215mm
542052	Drill bit, AO, Ø4.3mm x 145mm
542053	Drill bit, AO, Ø4.3mm x 215mm
542054	Drill bit, AO, Ø4.5mm x 135mm
542024	Tap, locking, AO, Ø4.0mm x 145mm
542057	Tap, locking, AO, Ø5.0mm x 145mm
705054	Tap, Cancellous, Ø6mm x 180mm
702808	Tap, AO, Ø4.5 x 145mm
390192	K-wire, Ø2.0 x 150mm
705002	K-wire drill tip, Ø2.0 x 234mm

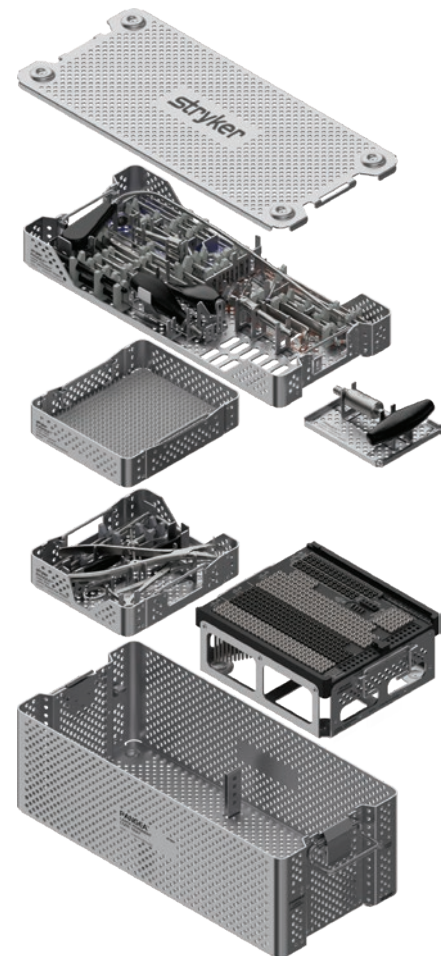

System components

Pangea Large Fragment Core Tray

Top level consisting of the instruments listed below:

Torque limiter insert instruments

Ref #	Description
542068	Torque limiting T-handle, AO, T20 6Nm

System components

Pangea Large Fragment Core Tray - Instruments

Third level consisting of the instruments listed below:

This level can be removed and replaced with the optional inserts: Core tray large fragment reduction insert or core tray Asnis III 4.0mm cannulated screw insert.

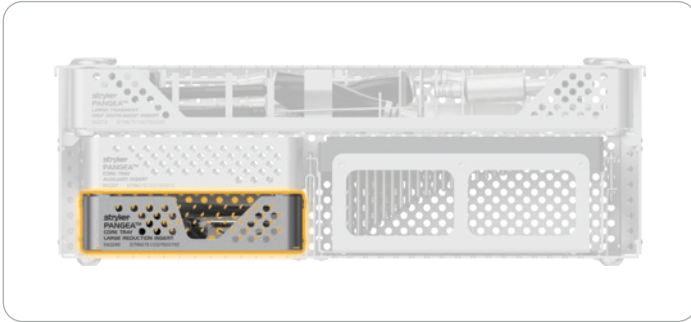

Ref #	Description
542207	Core tray auxiliary insert
542208	Silicone mat, auxiliary insert

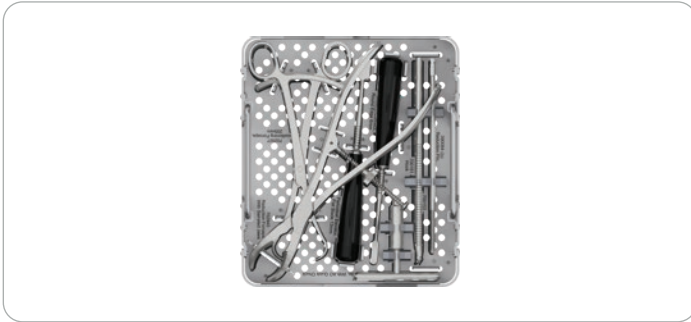
Pangea Large Fragment Core Tray - Optional large fragment reduction insert

Ref #	Description
542249	Core tray large reduction insert

Instruments

Ref #	Description
700151	Hook
700153	Ball spike
705294	Periosteal elevator, round edge 6mm
705295	Periosteal elevator, flat blade 13mm
702927	Repositioning forceps, L205mm
702940	Reduction forceps with serrated jaws
390084	Reduction pin, AO, Ø5.0 x 180mm
700367	T-handle, AO quick-chuck

System components

Pangea Large Fragment Core Tray - Screws

Screw rack consisting of the implants listed below:

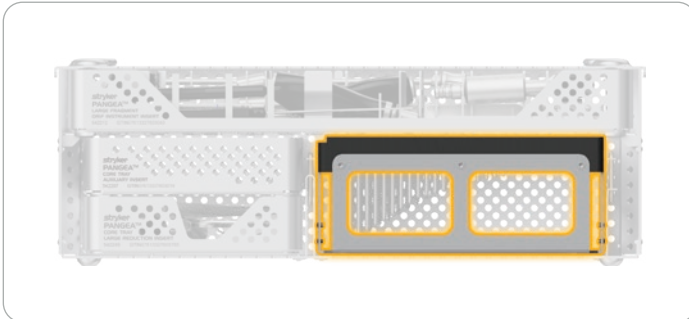

Ref #	Description
542213	Large fragment screw rack (with lid)
542214	Large fragment screw rack lid

4.0mm locking screw self-tapping, T20 drive

Ref #	Length (mm)	Ref #	Length (mm)
662214	14	662242	42
662216	16	662244	44
662218	18	662246	46
662220	20	662248	48
662222	22	662250	50
662224	24	662255	55
662226	26	662260	60
662228	28	662265	65
662230	30	662270	70
662232	32	662275	75
662234	34	662280	80
662236	36	662285	85
662238	38	662290	90
662240	40	662295	95



*Sterile packed only

Note: All non-sterile plates and screws may be ordered sterile by placing an "S" at the end of the ref number. Sterile option availability varies by market

System components

Pangea Large Fragment Core Tray - Screws

Screw rack consisting of the implants listed below:

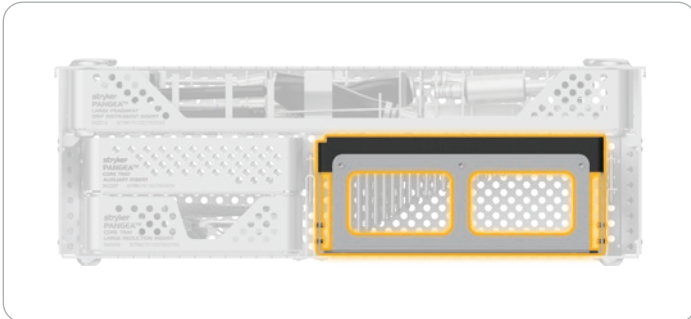

5.0mm locking screw self-tapping, T20 drive

Ref #	Length (mm)	Ref #	Length (mm)
662314	14	662348	48
662316	16	662350	50
662318	18	662355	55
662320	20	662360	60
662322	22	662365	65
662324	24	662370	70
662326	26	662375	75
662328	28	662380	80
662330	30	662385	85
662332	32	662390	90
662334	34	662395	95
662336	36	662400S*	100
662338	38	662405S*	105
662340	40	662410S*	110
662342	42	662415S*	115
662344	44	662420S*	120
662346	46		



5.0mm periprosthetic locking screw self-tapping, T20 drive

Ref #	Length (mm)	Ref #	Length (mm)
661210	10	661216	16
661212	12	661218	18
661214	14	661220	20



*Sterile packed only

Note: All non-sterile plates and screws may be ordered sterile by placing an "S" at the end of the ref number. Sterile option availability varies by market

System components

Pangea Large Fragment Core Tray - Screws

Screw rack consisting of the implants listed below:

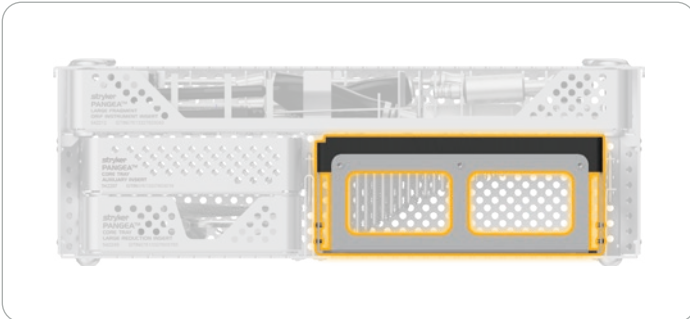

4.5mm cortex screw self-tapping, T20 drive

Ref #	Length (mm)	Ref #	Length (mm)
661714	14	661760	60
661716	16	661765	65
661718	18	661770	70
661720	20	661775	75
661722	22	661780	80
661724	24	661785	85
661726	26	661790	90
661728	28	661795	95
661730	30	661800S*	100
661732	32	661805S*	105
661734	34	661810S*	110
661736	36	661815S*	115
661738	38	661820S*	120
661740	40	661825S*	125
661742	42	661830S*	130
661744	44	661835S*	135
661746	46	661840S*	140
661748	48	661845S*	145
661750	50	661850S*	150
661755	55		



Cable plugs and washers

Ref #	Description
662202S*	5.0mm cable plug
663201	Washer, T20



*Sterile packed only

Note: All non-sterile plates and screws may be ordered sterile by placing an "S" at the end of the ref number. Sterile option availability varies by market

System components

Pangea Large Fragment Core Tray - Screws

Screw rack consisting of the implants listed below:

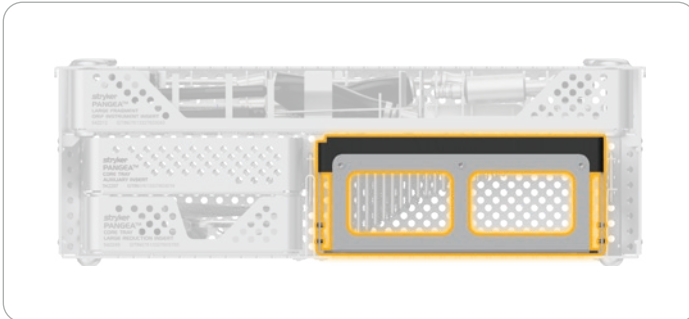

6.0mm cancellous screw full thread, T20 drive

Ref #	Length (mm)	Ref #	Length (mm)
608020	20	608090	90
608025	25	608095	95
608030	30	608100S*	100
608035	35	608105S*	105
608040	40	608110S*	110
608045	45	608115S*	115
608050	50	608120S*	120
608055	55	608125S*	125
608060	60	608130S*	130
608065	65	608135S*	135
608070	70	608140S*	140
608075	75	608145S*	145
608080	80	608150S*	150
608085	85		



*Sterile packed only

Note: All non-sterile plates and screws may be ordered sterile by placing an "S" at the end of the ref number. Sterile option availability varies by market

System components

Pangea Large Fragment Core Tray - Screws

Screw rack consisting of the implants listed below:

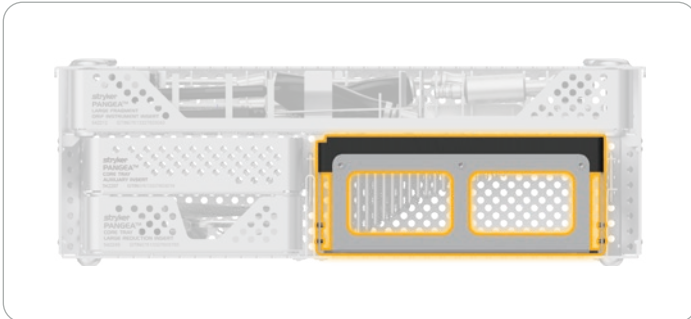

6.0mm cancellous screw, 16mm thread T20 drive

Ref #	Length (mm)	Ref #	Length (mm)
608230	30	608295	95
608235	35	608300S*	100
608240	40	608305S*	105
608245	45	608310S*	110
608250	50	608315S*	115
608255	55	608320S*	120
608260	60	608325S*	125
608265	65	608330S*	130
608270	70	608335S*	135
608275	75	608340S*	140
608280	80	608345S*	145
608285	85	608350S*	150
608290	90		



*Sterile packed only

Note: All non-sterile plates and screws may be ordered sterile by placing an "S" at the end of the ref number. Sterile option availability varies by market

System components

Pangea Large Fragment Core Tray - Screws

Screw rack consisting of the implants listed below:

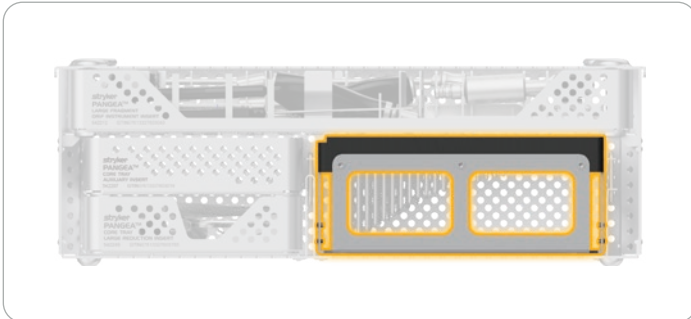

6.0mm cancellous screw, 32mm thread, T20 drive

Ref #	Length (mm)	Ref #	Length (mm)
608445	45	608500S*	100
608450	50	608505S*	105
608455	55	608510S*	110
608460	60	608515S*	115
608465	65	608520S*	120
608470	70	608525S*	125
608475	75	608530S*	130
608480	80	608535S*	135
608485	85	608540S*	140
608490	90	608545S*	145
608495	95	608550S*	150



*Sterile packed only

Note: All non-sterile plates and screws may be ordered sterile by placing an "S" at the end of the ref number. Sterile option availability varies by market

1. Schmidt, W et al. "Stryker Orthopaedic Modeling and Analytics (SOMA): A Review." *Surgical Technology International*, vol. 32 (2018): 315-324.

This document is intended solely for the use of healthcare professionals. A surgeon must always rely on his or her own professional clinical judgment when deciding whether to use a particular product when treating a particular patient. Stryker does not dispense medical advice and recommends that surgeons be trained in the use of any particular product before using it in surgery.

The information presented is intended to demonstrate a Stryker product. A surgeon must always refer to the package insert, product label and/or instructions for use, including the instructions for cleaning and sterilization (if applicable), before using any Stryker product. Products may not be available in all markets because product availability is subject to the regulatory and/or medical practices in individual markets. Please contact your Stryker representative if you have questions about the availability of Stryker products in your area.

The instructions for use, operative techniques, cleaning instructions, patient information leaflets and other associated labeling may be requested online at ifu.stryker.com or stryker.com. If saving the instructions for use, operative techniques, cleaning instructions from the above mentioned websites, please make sure you always have the most up to date version prior to use.

Stryker Corporation or its divisions or other corporate affiliated entities own, use or have applied for the following trademarks or service marks: Stryker, Axsos 3, Dall-Miles, and Pangea. All other trademarks are trademarks of their respective owners or holders.



Manufacturer:
Stryker GmbH
Bohnackerweg 1
2545 Selzach, Switzerland
www.stryker.com