

Gamma4™

Hip Fracture Nailing System



Operative technique



Gamma4

Hip Fracture Nailing System

Contents

1. Introduction	3	Compression / apposition	39
2. Indications and contraindications	4	RC Lag Screw	40
3. Warnings and precautions	5	RC Lag Screw insertion	40
4. MRI safety information	6	U-Blade insertion	41
5. Implant design	7	U-blade end cap Insertion	42
6. Operative technique	14	Set screw fixation	43
Pre-operative planning	14	Guided locking	45
Patient positioning and reduction	15	Trochanteric Nail distal locking	45
Incision	17	Intermediate Nail distal locking	48
Entry point	19	Assembly of Intermediate Targeting Sleeve	49
Entry point optimization	20	Locking	50
Preparation of the medullary canal	21	Disassembly	51
Long Nail selection	24	Long Nail distal locking	52
Targeting Arm	25	Introduction	52
Proximal Targeting Arm assembly	26	Assembly	53
Nail insertion	29	Pre-operative length verification	54
Implant positioning	30	Operative assembly	55
Implant positioning with One Shot Device	31	Oblique C-arm positioning	56
Sleeve insertion	32	Height and orbital rotation of the C-arm	57
Anti-Rotation Clip	33	Sleeve adjustment	58
Assembly	33	Locking	59
Insertion of Anti-Rotation Sleeve	33	Disassembly	60
Precision Pin™ placement	34	Freehand distal locking	61
Removal of Anti-Rotation Clip	34	Advanced Locking Screws	63
Lag Screw measurement	36	End Cap insertion	66
Lag Screw reaming	37	Post-operative care and rehabilitation	67
Lag Screw insertion	38	Extraction	68
		Optional bone void filler	71
		7. System components	74

This publication sets forth detailed recommended procedures for using Stryker devices and instruments. It offers guidance that you should heed, but, as with any such technical guide, each surgeon must consider the particular needs of each patient and make appropriate adjustments when and as required.

⚠ WARNING

Follow the instructions provided in our cleaning and sterilization guide (OT-RG-1). All non-sterile devices must be cleaned and sterilized before use.

⚠ CAUTION

Multicomponent instruments must be disassembled for cleaning. Please refer to the corresponding assembly / disassembly instructions.

Please remember that the compatibility of different product systems has not been tested unless specified otherwise in the product labeling. Consult Instructions for Use (www.ifu.stryker.com) for a complete list of potential adverse effects, contraindications, warnings and precautions.

⚠ WARNING

- The surgeon must advise patients of surgical risks, and make them aware of adverse effects and alternative treatments.
- The implantation affects the patient’s ability to carry loads and her/his mobility and general living circumstances. For this reason, the surgeon must counsel each patient individually on appropriate behavior and activity-level after the surgery.
- The patient should be advised that the device cannot and does not replicate a normal healthy bone, that the device can break or become damaged as a result of strenuous activity or trauma and that the device has a finite expected service life. Removal or revision of the device may be required sometime in the future due to medical reasons.

Introduction

The Gamma4 Hip Fracture Nailing System features a variety of neck-shaft angles (Centrum-Collum-Diaphyseal [CCD] angle), distal diameters, lengths and distal locking configurations (Trochanteric, Intermediate and Long Nails) in order to accommodate anatomical variations in the femur. The nails are designed to be fixated by Lag Screws in the femoral head and by Advanced/Locking Screws in the shaft. The pre-inserted and cannulated set screw is designed to control rotation and dynamization of the proximal fragment, allowing for controlled subsidence. The End Cap is designed for proximal closure of the nail to prevent bony ingrowth. For a general design and component overview of a Gamma4 nail, refer to the 'Implant and instrument design' section below.

The Gamma4 System is implanted using the indication specific instruments found in the Gamma4 Indication Kit (1420-0000), as well as general nailing instruments found in the IM Nailing Basic Instruments Kit (2356-0580). The IM Nailing Femur Antegrade Distal Targeting Kit (2356-0680) can be used for distal locking of long nails (refer to section 'Guided locking - Long Nail distal locking').

This operative technique has been devised in consultation with leading surgeons in many countries to be a basic guide, particularly for less experienced users of the Gamma4 System. It is acknowledged that several alternative approaches to certain elements of the procedure are available, and may have advantages for particular situations or surgeons.

For an overview of all components and compatibilities, refer to the 'System components' section below.

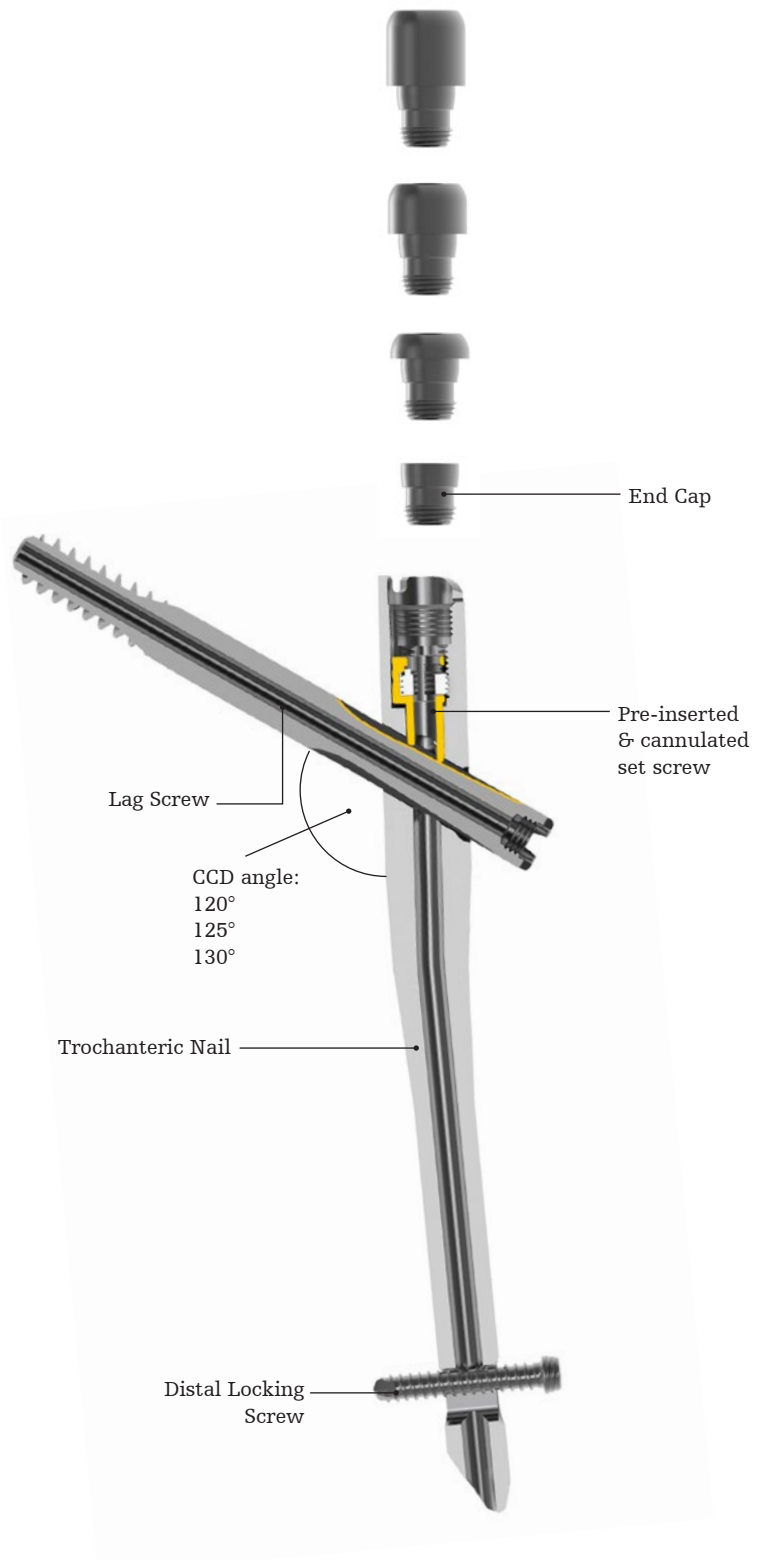

Indications and contraindications

Intended Use

The Gamma4 System is intended to achieve functionally stable osteosyntheses and stabilization of bones and bone fragments.

Indications

The Gamma4 System is indicated for the treatment of stable and unstable fractures as well as for stabilization of bones and correction of bone deformities in the intracapsular, trochanteric, subtrochanteric and shaft regions of the femur (including osteoporotic and osteopenic bone).

The RC Lag Screw is also indicated for rotationally unstable fractures.

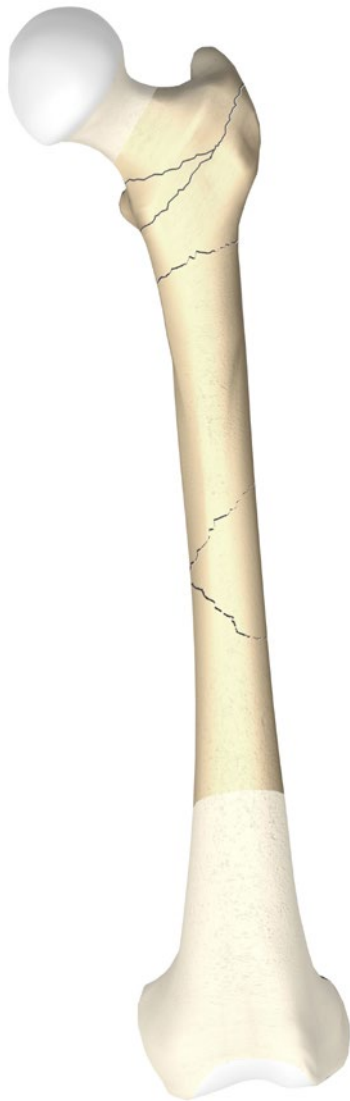

Contraindications

The physician's education, training and professional judgment must be relied upon to choose the most appropriate device and treatment. Conditions presenting an increased risk of failure include:

- Any active or suspected latent infection or marked local inflammation in or about the affected area.
- Compromised vascularity that would inhibit adequate blood supply to the fracture or the operative site.
- Bone stock compromised by disease, infection or prior implantation that can not provide adequate support and/or fixation of the devices.
- Material sensitivity, documented or suspected.
- Patients having inadequate tissue coverage over the operative site.
- Implant utilization that would interfere with anatomical structures or physiological performance.
- Any mental or neuromuscular disorder which would create an unacceptable risk of fixation failure or complications in postoperative care.
- Other medical or surgical conditions which would preclude the potential benefit of surgery.

Warnings and precautions

WARNING

Internal fixation of medial neck fractures is associated with high complication rates, but a successful treatment may preserve the patient's hip joint. The surgeon must use his or her own professional clinical judgment to thoroughly evaluate the potential advantages, disadvantages and all risks associated with the use of the Gamma4 System in medial neck fractures, and discuss them with the patient, when necessary.

For rotationally unstable fractures, additional fixation is strongly recommended.

WARNING

Single use devices must not be reused, as they are not designed to perform as intended after the first usage. Changes in mechanical, physical or chemical characteristics introduced under conditions of repeated use, cleaning and re-sterilization may compromise the integrity of the design and/or materials leading to diminished safety, performance and/or compliance with relevant specifications. Please refer to the device label to identify single or multiple use and/or cleaning and re-sterilization release.

WARNING

The Gamma4 Nail is designed for temporary implantation until bone consolidation occurs. Therefore if no bone consolidation occurs or if consolidation is not sufficient, the system may break. The aim of post-operative care must be to ensure the promotion of bone consolidation. The Gamma4 Nail is not intended for full weight bearing in patients with complex unstable fractures until sufficient bone consolidation is confirmed in the follow-up X-rays.

Long nails may provide higher stability due to longer distance between locking configuration and fracture line; especially important for subtrochanteric fractures and even more for shaft fractures.

CAUTION

Take care during drilling/reaming to avoid heterotopic ossification.

WARNING

Take care during the procedure to avoid unintended bone and soft tissue damage which could lead to severe post-operative complications, such as avascular necrosis, which may result in implant failure.

WARNING

The surgical outcome strongly depends on the selection of the correct implant dimensions and the implantation process. Be cautious to choose the correct implants as well as locking configurations and to follow the instructions in this operative technique.

WARNING

Do not engage the set screw prior to proper Lag Screw placement. This ensures that the set screw is not protruding into the Lag Screw bore hole and damaged during the procedure.

WARNING

Ensure that pins/wires do not get lodged in the cannulated instruments to avoid unintended bone or soft tissue damage. This should be monitored under X-ray.

MRI safety information

MRI safety information

A patient with the Gamma4 Implants may be safely scanned under the following conditions. Failure to follow these conditions may result in injury to the patient.

Device name	Gamma4
Static Magnetic Field Strength (T)	1.5 T and 3.0 T
Maximum Spatial Field Gradient	30 T/m (3000 gauss/cm)
RF Excitation	Circularly Polarized (CP)
RF Transmit Coil Type	Integrated Whole Body Transmit Coil
Operating Mode	Normal Operating Mode
Maximum Whole-Body SAR (W/kg)	2 W/kg (Normal Operating Mode)
Scan Duration	<p>1.5 Tesla 2 W/kg whole-body average SAR for 6 minutes of continuous RF (a sequence or back to back series/scan without breaks) followed by a wait time of 6 minutes if this limit is reached, for the total scanning session duration of up to 1 hour (or 60 minutes).</p> <p>3.0 Tesla 2 W/kg whole-body average SAR for 1 hour (or 60 minutes) of continuous RF (a sequence or back to back series/scan without breaks).</p>
MR Image Artifact	The presence of this implant produced an image artifact of approximately 27mm from the Gamma4 System when imaged with a spin echo or gradient echo pulse sequence and a 3.0 T MRI system.
Additional instructions	<p>⚠ CAUTION</p> <p>The MRI safety information provided is based on testing which did not include supplementary devices. If there are supplementary devices (i.e. plates, screws, wires, etc.) present in proximity to the Gamma4 System, this could result in additional MRI effects and the information provided above may not apply.</p>

Implant design

5.1. Trochanteric Nail

The Gamma4 Trochanteric Nail is 170mm long and has a 4° ML bend. Diameter options include 9,10,11,12 and 13mm. Due to the straight shaft it can be universally applied (left/right). The distance from the proximal end of the nail to the Lag Screw has been reduced by 5mm compared to the legacy system.

For design specifications, refer to Fig. 1.

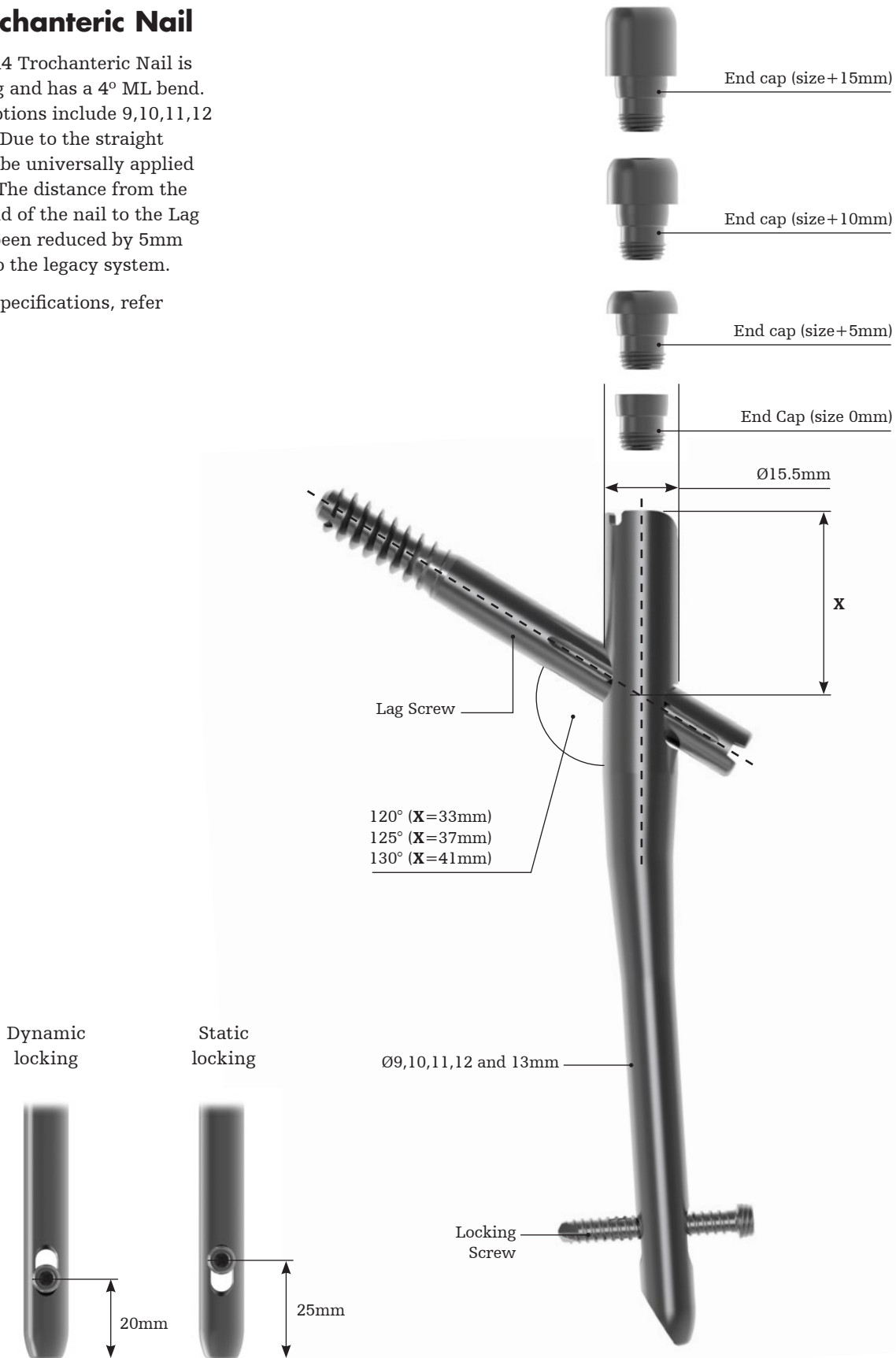

Fig. 1

Implant design

5.2. Intermediate Nail

The Gamma4 Intermediate Nail is 240mm long and has a 4° ML bend and 3° AP bend. Diameter options include 9,10,11,12 and 13mm. The shaft radius of curvature is approximately 750mm. The distance from the proximal end of the nail to the Lag Screw is identical to the Trochanteric Nail and Long Nail. For design specifications, refer to Fig. 2.

Distal Locking

- One static hole that accepts Advanced Locking Screws, as well as standard Locking Screws
- One oblong hole that accepts Locking Screws only

Remove this screw to allow for dynamization

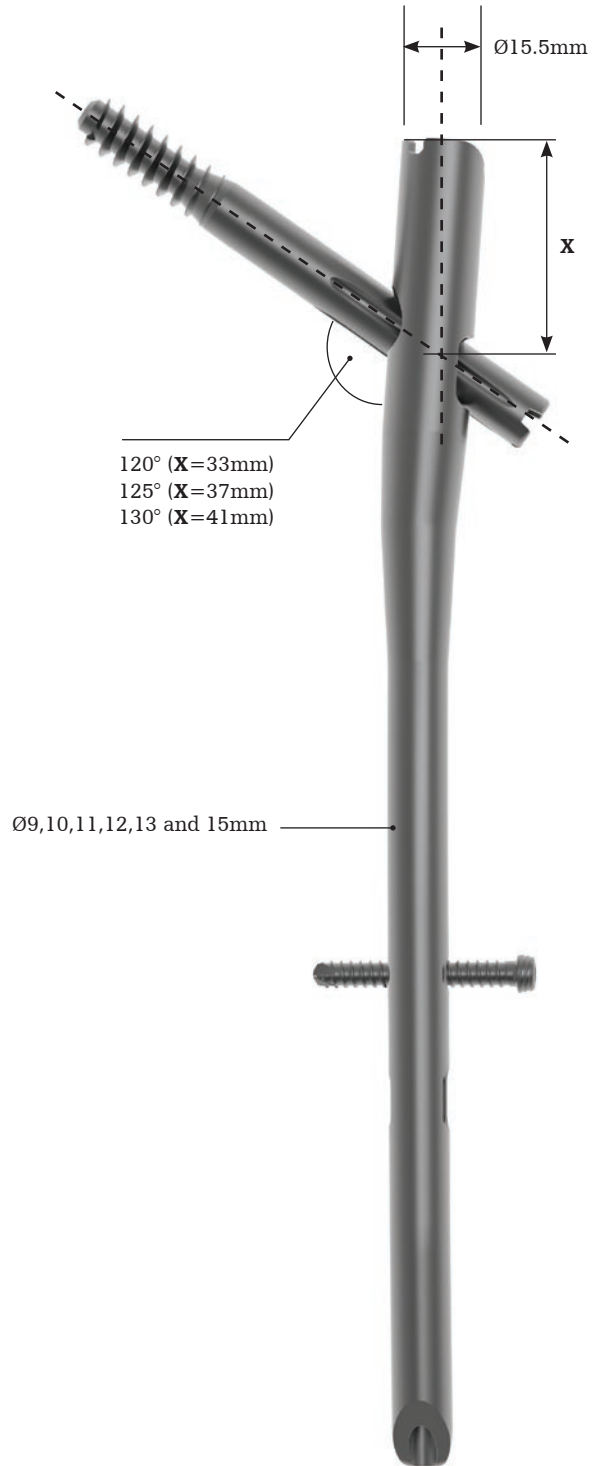
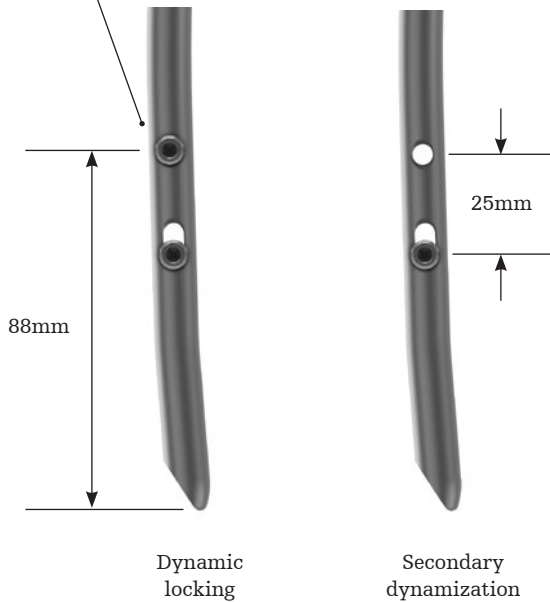

Fig. 2

Implant design

5.3. Long Nail

The Gamma4 Long Nail is available in lengths from 240mm to 480mm (20mm increments).

The proximal portion is identical to the Trochanteric Nail and Intermediate Nail. Specific features of the Long Nail include:

Lag Screw opening

- 10° anteversion

Shaft

- Diameter options of 9,10,11,12,13 and 15mm
- 3° AP bend, 4° ML bend
- Length-dependent radii of curvature ranging from 0.75-1.35m

Length dependent radius of curvature

Length (mm)	RoC (m)
240	0.75
260	0.80
280	0.85
300	0.90
320	0.95
340	1.00
360	1.05
380	1.10
400	1.15
420	1.20
440	1.25
460	1.30
480	1.35

Distal Locking

- Two static holes that accept Advanced Locking Screws, as well as standard Locking Screws
- One oblong hole that accepts Locking Screws only

For design specifications, refer to Fig. 3.

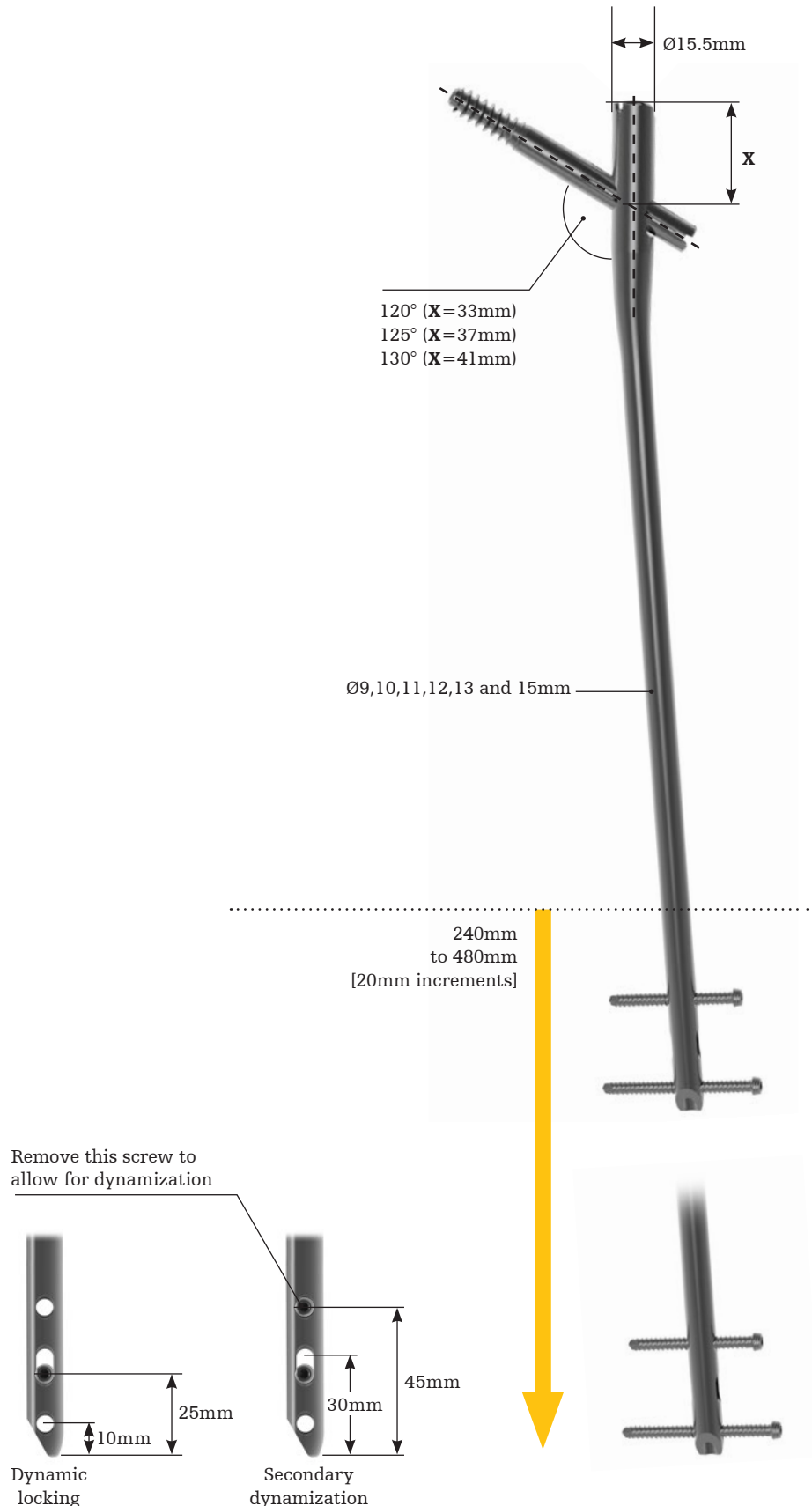

Fig. 3
9

Implant design

5.4. Screws and accessories

Lag Screw

The Lag Screw is available in two different types: Lag Screw (Fig. 4a) and RC Lag Screw (Fig. 4b and 4c). Both lag screw options are available in lengths from 70 to 130mm in 5mm increments. The diameter of all Lag screws is 10.5mm. The RC Lag Screw is designed to provide additional rotational stability and fixation performance.*

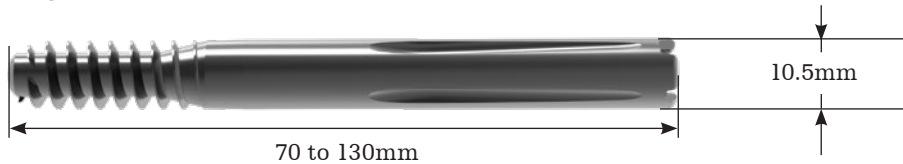

Fig. 4 a

The RC screw consists of three parts: RC Lag Screw, U-blade and U-blade end cap (Fig. 4b). It will be delivered disassembled in the packaging.

When the U-blade is assembled to the RC Lag Screw, the width of the tip is increased to 12.5mm due to the spread of the U-blade (Fig. 4c).



Fig. 4b



Fig. 4c

Set screw

The set screw (Fig. 5) is pre-inserted and cannulated in all Gamma4 nails. The set screw mechanism allows for control of rotation and for lateral dynamization of the proximal fragment, while preventing medial migration of the Lag Screw.



Fig. 5

*Born et al. Hip screw Migration Testing: First Results for Hip Screws and Helical Blades utilizing a newoscillating Test Method. J Orthop Res. 2011 May;29(5):750-6.

Implant design

Locking Screw

The Locking Screws (IMN Screws System) are used to control rotational and axial fixation of the nail. It is available in lengths from 25 to 120mm in 5mm increments. Additionally, 2.5mm increments are available from 25 to 60mm. Refer to Fig. 6.

The Ø5mm Advanced Locking Screws (Fig. 7) are designed to limit the relative axial and angular movement between the nail and screw construct. These implants are designed to increase construct stability within unstable fracture patterns and/or poor bone quality. They are available in lengths from 60 to 100mm in 5mm increments. Additionally, 2.5mm increments are available from 30 to 60mm. They can be used in all round holes.

Locking screw

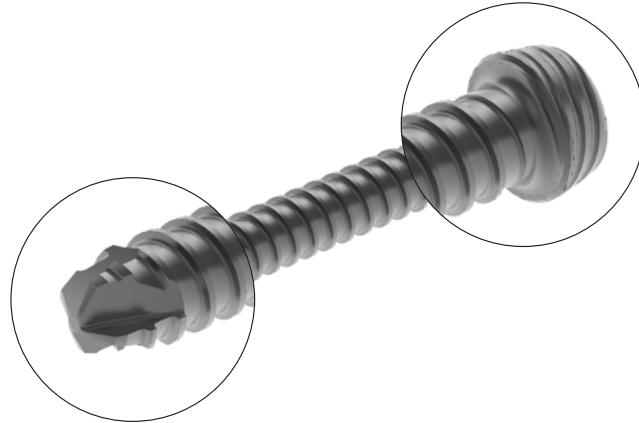
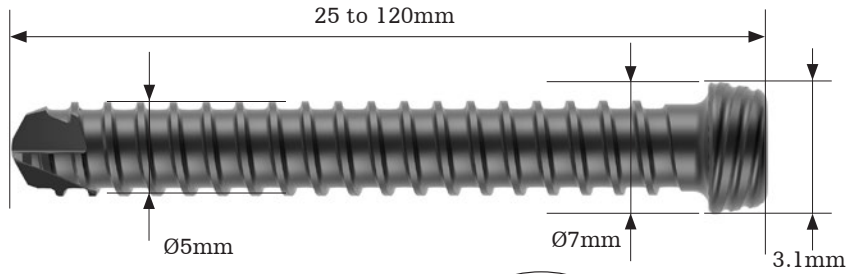

Fig. 6

Advanced Locking Screw

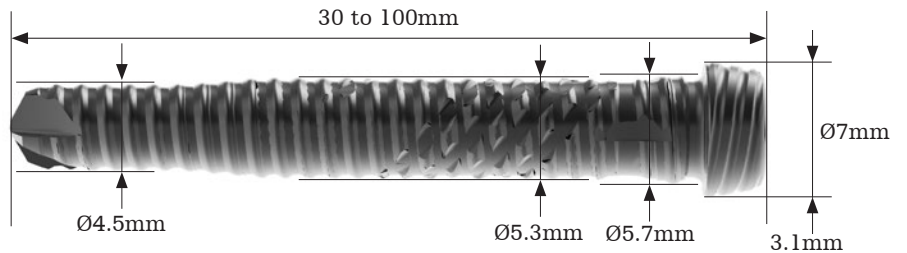

Fig. 7

End Cap

The End Cap is designed for proximal closure of the nail to prevent bony ingrowth. It is available in four different sizes: 0mm, 5mm, 10mm, 15mm. Refer to Fig. 8.



size 0mm

size +5mm

size +10mm

size +15mm

Fig. 8

Implant design

Packaging

The implants of the Gamma4 and IMN Screws System include packaging that minimizes user contact with the implant prior to implantation. After the pouch is opened, all implants include a sheath that is introduced into the sterile field.

Example 1: nail is removed from pouch (Fig. 9), sheath is opened (Fig. 10), then the sterile nail is attached to the Proximal Targeting Arm with the Nail Holding Screw (Fig. 11).

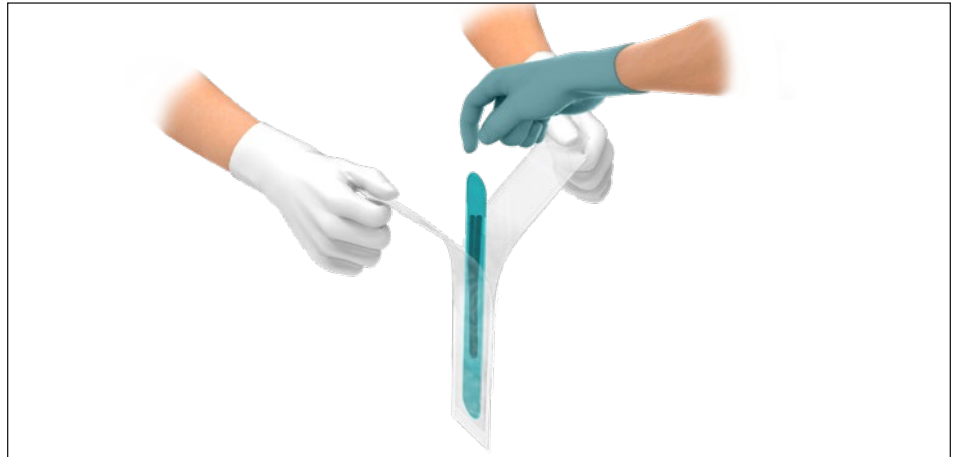

Fig. 9

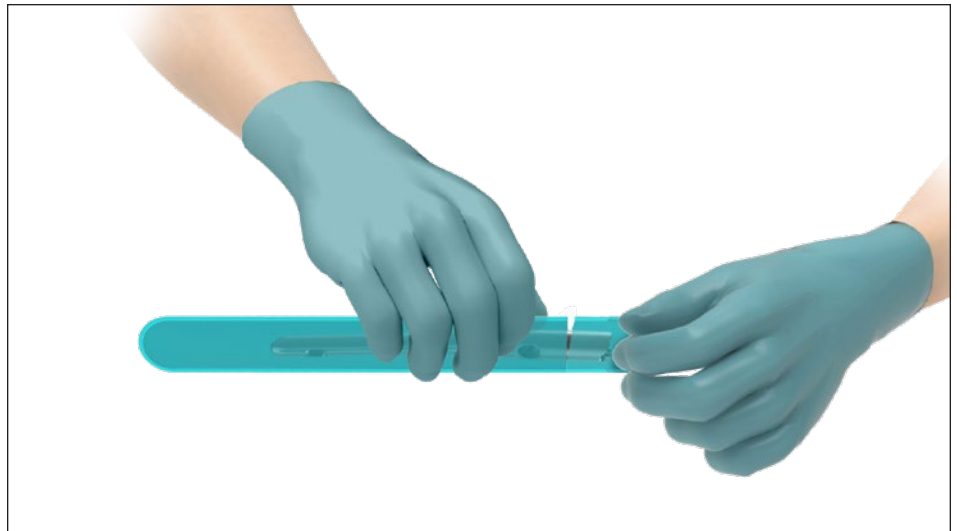

Fig. 10



Fig. 11

Implant design

Example 2: After removal from pouch (Fig. 12), Locking Screw, End Cap or other implant is attached to the corresponding screwdriver (Fig. 13).



Fig. 12

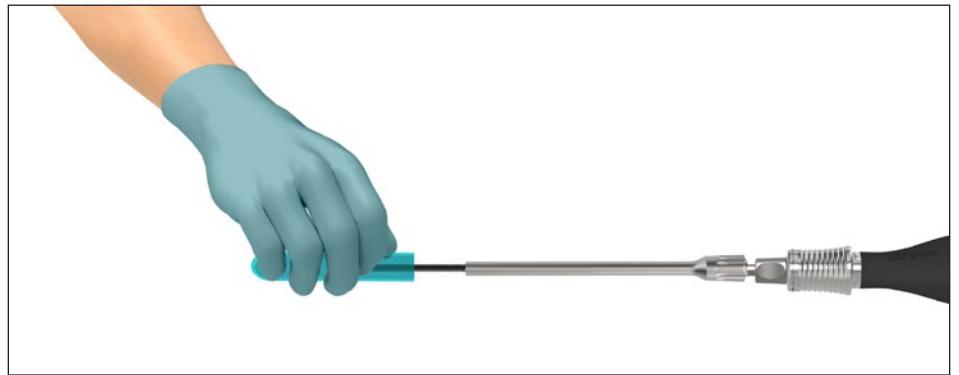

Fig. 13

Operative technique

Pre-operative planning

The Gamma4 X-ray templates can be provided digitally or as a physical overlay. The use of these templates in association with adequate X-ray/fluoroscopy are strongly recommended. These may assist in the selection of an appropriately sized implant (length, diameter and CCD angle) during pre-operative planning.

Physical templates show the true implant size at a magnification of 15% in anterior-posterior frontal view. If accurate anatomical reduction has been achieved, the X-ray can be taken from the fractured hip or from the contralateral side. An accurate neck-shaft angle can only be measured if the X-ray projection is adapted to the anatomical anteversion. This projection can be achieved by adjusting the X-ray beam 90° off a true lateral, where the femoral neck axis is parallel to the proximal diaphysis. Alternatively the CCD angle, the angle between the femoral shaft axis and the femoral neck axis, could be measured using a goniometer. The implant fit to the patient's anatomy should be strongly considered prior to implant use.

Operative technique

Patient positioning and reduction

Patient positioning for femoral nail insertion is surgeon dependent. The patient is typically placed in a supine position on a fracture table and closed reduction of the fracture is recommended. The unaffected limb can be extended (Fig. 14) or abducted (Fig. 15) to facilitate the procedure. Reduction should be achieved as anatomically as possible. If this is not achievable in a closed procedure, open reduction may be necessary. Positioning of the patient on a flat top table in a lateral position may also be considered, but may be difficult to obtain the necessary images.

Position the C-arm in order to easily obtain both anterior-posterior (A-P) and mediolateral (M-L) projections of the affected trochanteric region of the femur (Fig. 16). Center the C-arm's axis of rotation on the femoral neck of the affected femur. It is important to ensure that a view of both the distal and proximal ends of the nail can be obtained during the procedure without obstruction by the fracture table.

To counter misalignment, the trunk may be shifted to the opposite side and held in position by a thoracic rest or by a large drape. This tightens the gluteus medius muscles and relaxes the psoas, externally rotating the proximal fragment into alignment and exposing the greater trochanter for easier introduction of the nail.

Traction should be applied to the fracture while keeping the leg straight.

While maintaining traction, internally rotating the affected limb 10-15 degrees may help complete fracture reduction.

When positioning the drapes, bear in mind that the incision will be 2-3 cm proximal to the greater trochanter.

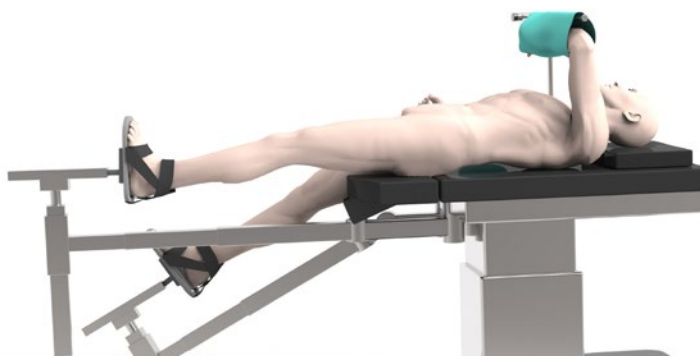

Fig. 14

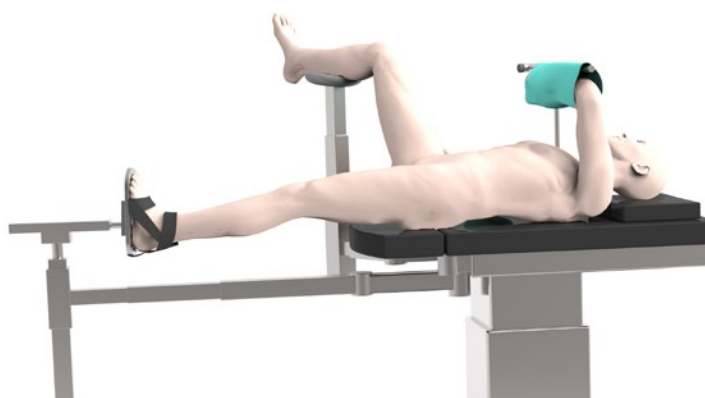

Fig. 15

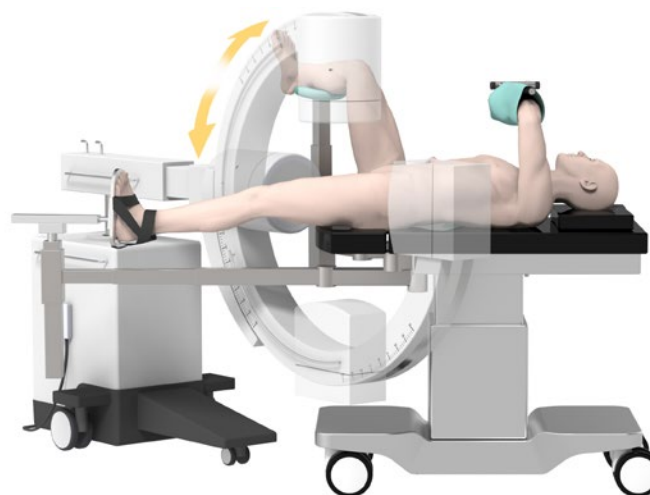

Fig. 16

⚠ WARNING

Reduction should be achieved as anatomically as possible. Insufficient reduction may lead to post-operative complications.

Operative technique

Alternative 1: Linear Reduction Clamp

The Linear Reduction Clamp may be used to help facilitate reduction of the bone and provisional fixation (Fig. 17, 18). Depending on the fracture pattern, the Linear Reduction Clamp has multiple attachments that can be passed through an incision (Fig. 19). Please be aware that the positioning of the instrumentation or any provisional fixation should not interfere with the Gamma4 instrumentation and procedure (Fig. 20, 21). Eight different hook orientation options and the removable handle may allow for more intraoperative flexibility while also allowing for clamp positioning that does not interfere with surrounding equipment. For more information please contact your local Stryker representative.

Ref #	Description
1320-0225	Reduction Spatula



Fig. 17

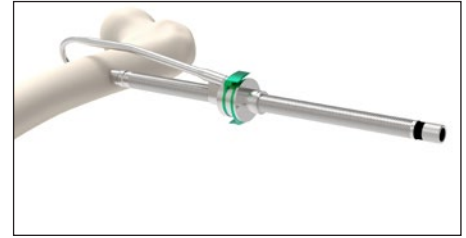

Fig. 18

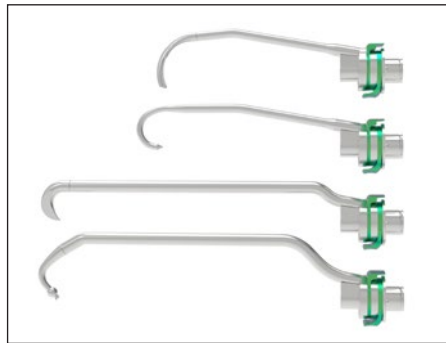

Fig. 19

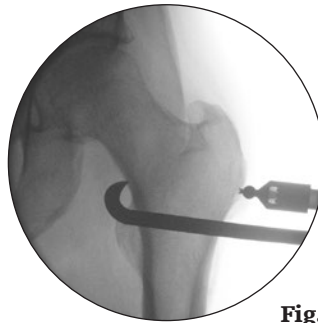

Fig. 20

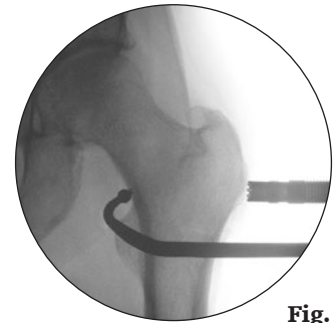

Fig. 21

Alternative 2: Reduction Spatula

The Reduction Spatula can be introduced through the entry point incision and slid along the surface of the trochanter until reaching the fracture (Fig. 22). Use the handle to manipulate the displaced fragment and hold this position until the Lag Screw is inserted.

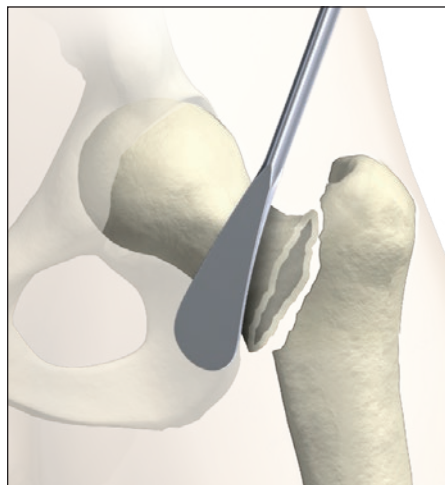

Fig. 22

Operative technique

Incision

Two alternatives for making the incision are described below.

Alternative 1:

The tip of the greater trochanter is located by palpation (Fig. 23). A horizontal incision is started approximately 2cm cranial, depending on the patient's body habitus. The incision is extended approximately 2-3cm, or more for obese patients, towards the iliac crest (Fig. 24). A small incision is made through the fascia lata, splitting the gluteal muscle approximately 1–2cm above the tip of the greater trochanter, thus exposing it.

Ref #	Description	Dimensions
1420-0060S	Precision Pin™	Ø3.9mm × 450mm
1420-0065S	Precision Pin™, tapered	Ø3.2/3.9mm × 450mm
2351-0390S	Locking Scalpel	



Fig. 23

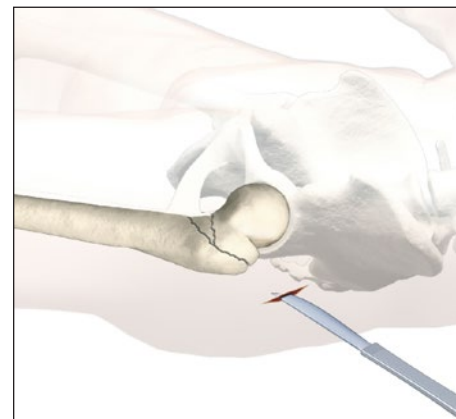

Fig. 24

Alternative 2:

The Precision Pin™ (450mm) is placed on the lateral side of the leg, centered with the proximal anatomy and passing through the desired entry point. The positioning is confirmed with a lateral X-ray (Fig. 25). A line is drawn on the skin (Fig. 26).

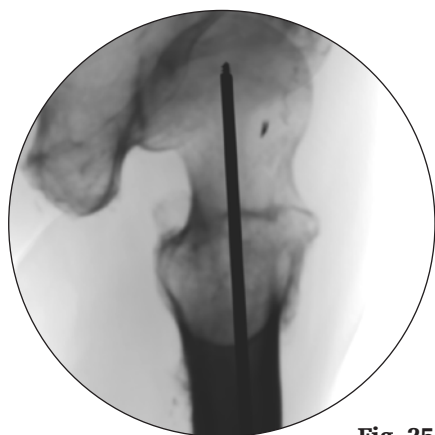

Fig. 25

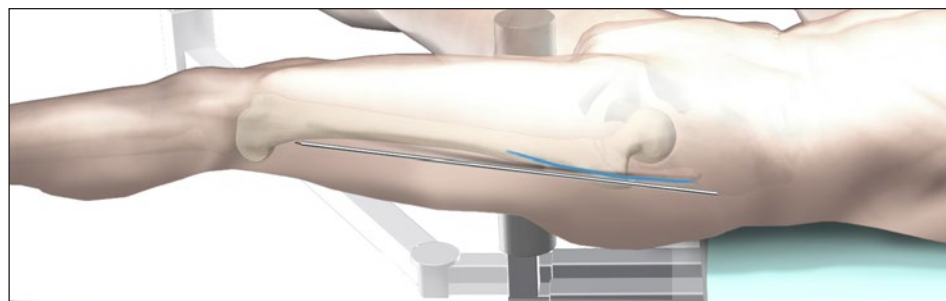

Fig. 26

Operative technique

The C-arm is rotated to provide an A-P image with the pin positioned on the tip of the greater trochanter.
(Fig. 27, 28).



Fig. 27

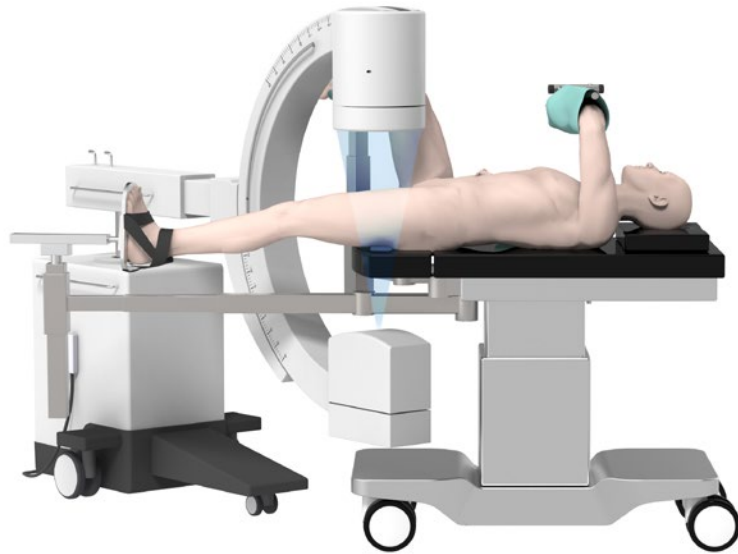

Fig. 28

A vertical line is drawn onto the skin (Fig. 29). The skin incision is made as described above in 'Alternative 1' and shown in Figures 30 and 31. You should now be able to feel the tip of the greater trochanter (Fig. 31).

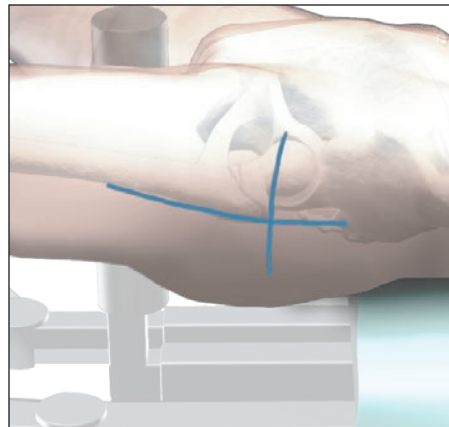

Fig. 29

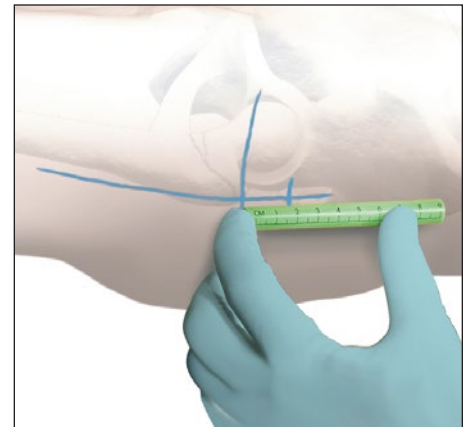

Fig. 30

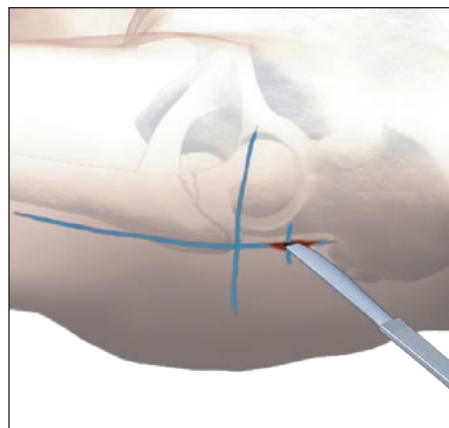

Fig. 31

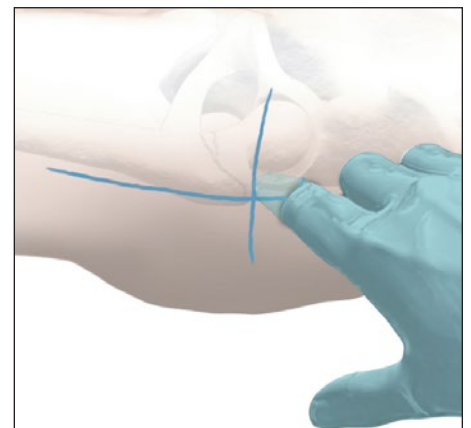

Fig. 32

Operative technique

Entry point

In the A-P view, the entry point is located on the tip of the greater trochanter. In order to define the optimal entry point in the lateral view, nail fit in the proximal diaphysis and Lag Screw placement in the femoral neck should be considered. In elderly patients, the optimal entry point is typically located slightly anterior from the center of the greater trochanter (Fig. 33). In smaller bones or narrow intramedullary canals (e.g. young patients) a rather posterior position may be chosen.

⚠ CAUTION

The correct entry point is essential for a good surgical outcome. Take care during entry point creation to avoid any unintended prolongation of surgery time, bone or soft tissue damage. Ensure to avoid slipping on bone during usage of opening instruments.

The entry point should be monitored under image intensification. Insert the Precision Pin™ at the entry point approximately 2-3cm into the bone.

Alternative:

The Curved Awl and Awl Plug can be used to find the entry point and open the cortex. The Ø3mm Guide Wire can be inserted through the cannulated awl.

Ref #	Description	Dimensions
1420-0060S	Precision Pin™	Ø3.9mm × 450mm
1420-0065S	Precision Pin™, tapered	Ø3.2/3.9mm × 450mm
2351-0010	Curved Awl	
2351-0011	Awl Plug	
2351-3100S	Guide Wire with Ruler Tube (optional)	

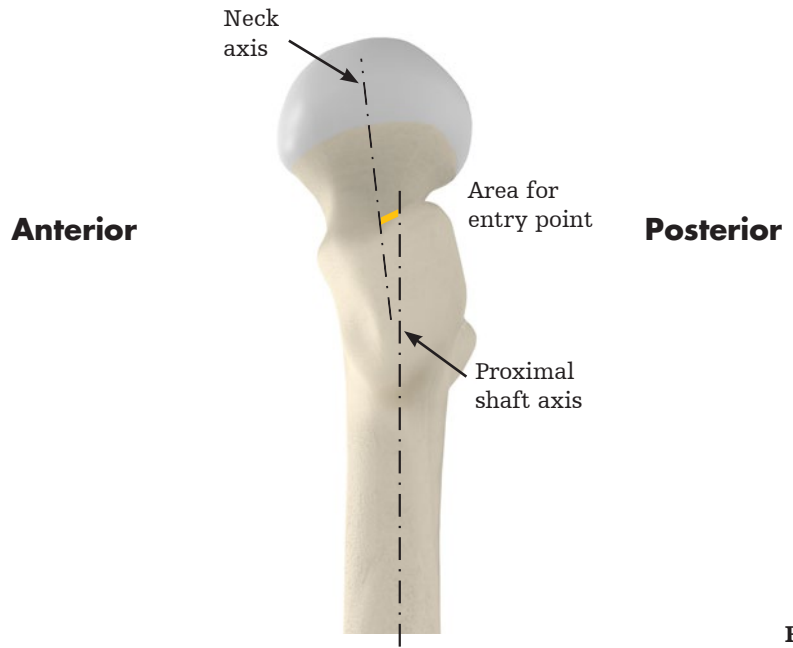

Fig. 33

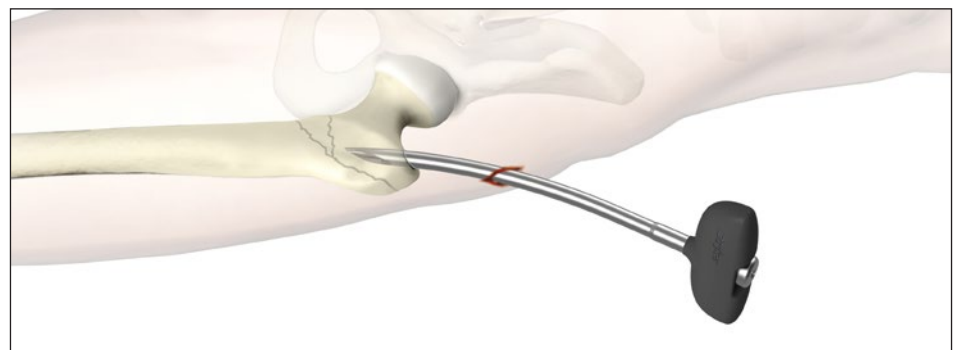

Fig. 34

Operative technique

Entry point optimization

The pin position may be corrected using a second pin in combination with the Opening Guide (Fig. 35). Two additional eccentric holes offer corrections with off-sets of 5 or 10mm, depending on if starting wire/pin is inserted in the center or eccentric hole.

Assemble the Opening Reamer Handle, Opening Sleeve and Opening Guide. Guide the assembly over the Ø3.9mm Precision Pin™, or Ø3mm Guide Wire, through the center hole until fully seated on the bone. Rotate the Opening Guide and use the eccentric holes to achieve the desired start position. Use imaging in the anterior and lateral views to confirm placement.

Ref #	Description	Dimensions
1420-0055	Opening Guide	
1420-0050	Opening Sleeve	
2351-6000	Opening Reamer Handle	
1420-0060S	Precision Pin™	Ø3.9mm × 450mm
1420-0065S	Precision Pin™, tapered	Ø3.2/3.9mm × 450mm
2351-3100S	Guide Wire with Ruler Tube (optional)	

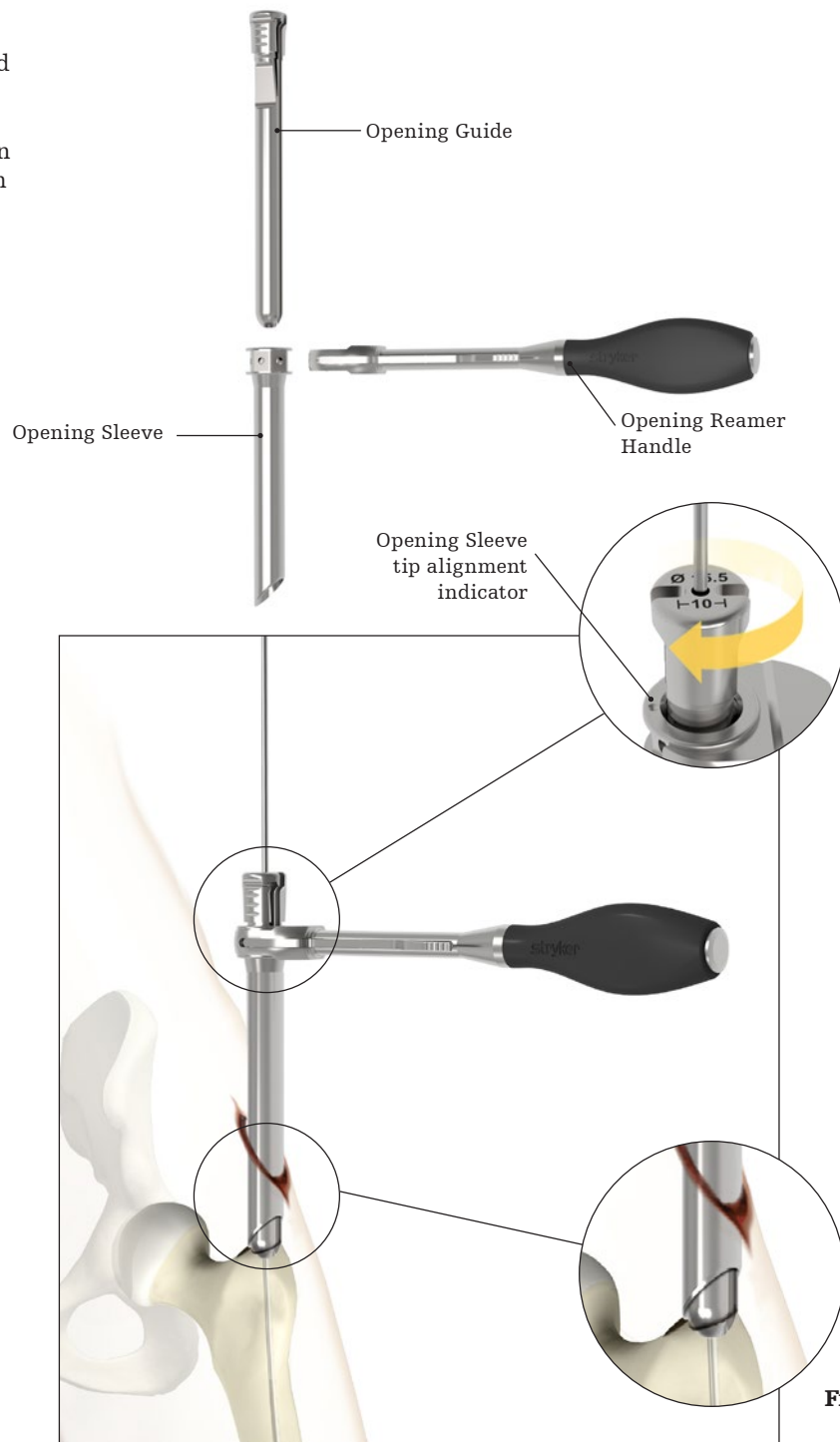

Fig. 35

Operative technique

Preparation of the medullary canal

In order to accommodate the proximal part of the nail, the proximal femur must be reamed up to Ø15.5mm to at least the level of the lesser trochanter. Two options to open the medullary canal are described below. In some cases, reaming of the subtrochanteric and diaphyseal region of the femoral cavity may not be required, particularly in elderly patients with wide medullary canals. In these cases, the nail may be inserted after opening of the canal.

Alternative 1: Reaming the medullary canal

The Guide Wire Handle is designed to control Guide Wire/pin placement with a single hand. The handle can be used for pins and wires ranging from 1.8 – 4mm in diameter. Counter-clockwise rotation of the adjustment wheel will allow for larger diameters.

The handle should be released when introducing the wire/pin (#1-2). Pulling the fixation handle temporarily clamps the wire/pin.

The Guide Wire Handle features a spring-loaded grip-pliers function to lock the wire/pin to the handle. With the wire/pin inserted, release the adjustment wheel (counter-clockwise) until the fixation handle can be fully closed (#3). Then tighten the adjustment wheel clockwise until it stops (#4). Open the fixation handle with the release lever (#1) and turn the wheel another ¼ turn (#4). Now the wire/pin can be locked to the Guide Wire Handle (#3). Fine adjustment of the spring force can be achieved with the adjustment wheel when the handle is unlocked. For cleaning purposes, the adjusting wheel can be removed and the fixation handle pulled out along the internal slots. Assembly is done vice-versa.

The Reduction Rod and Quick-Lock Delta Handle assembly may be used as a fracture reduction tool to facilitate Guide Wire insertion through the fracture site (Fig. 38) once the proximal femur is reamed. Advance the Ball Tip Guide Wire through the fracture site to the level of the distal epiphyseal scar or the mid pole of the patella (Fig. 38a, 38b). Verify position of the Guide Wire tip in the anterior and lateral views.

Ref #	Description
2351-3100S	Guide Wire with Ruler Tube
2351-0030	Guide Wire Handle
1420-0050	Opening Sleeve
2351-6000	Opening Reamer Handle
2351-0020	Reduction Rod (optional)
2351-0140	Quick-Lock Delta Handle (optional)
2351-0380	Guide Wire Pusher (optional)

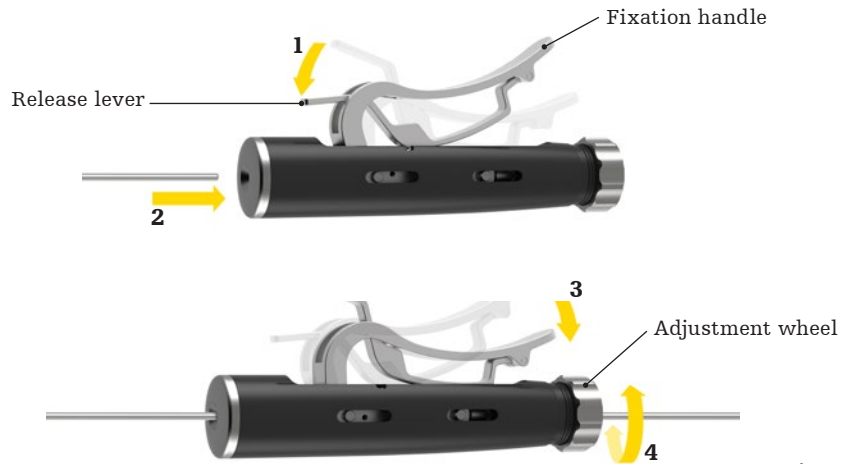

Fig. 36

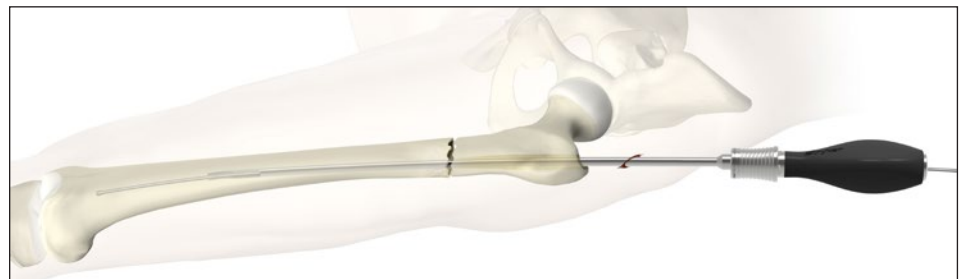

Fig. 37

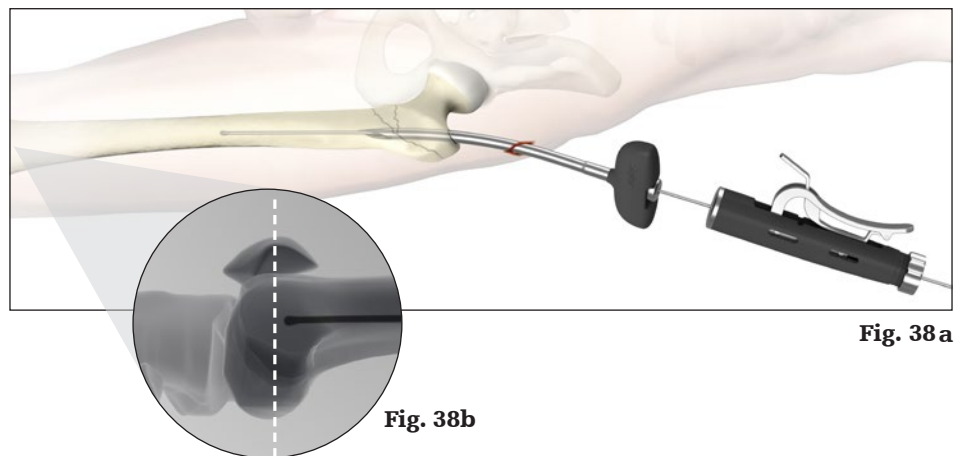

Fig. 38a

Fig. 38b

Operative technique

Once the Guide Wire is positioned as desired, remove the instruments used for insertion. You may use the Stryker Bixcut Reaming System and begin reaming in $\text{Ø}0.5\text{mm}$ increments (Fig. 39) until at least $\text{Ø}1.5\text{mm}$ larger than the desired nail diameter is achieved and the proximal femur is opened to $\text{Ø}15.5\text{mm}$. In some narrow medullary canals, over reaming may be required. The ball tip at the end of the Guide Wire will stop the reamer head.

To help maintain the position of the Guide Wire during reamer extraction, press the funnel tip end of the Guide Wire Pusher (Fig. 40) to the end of the power tool.

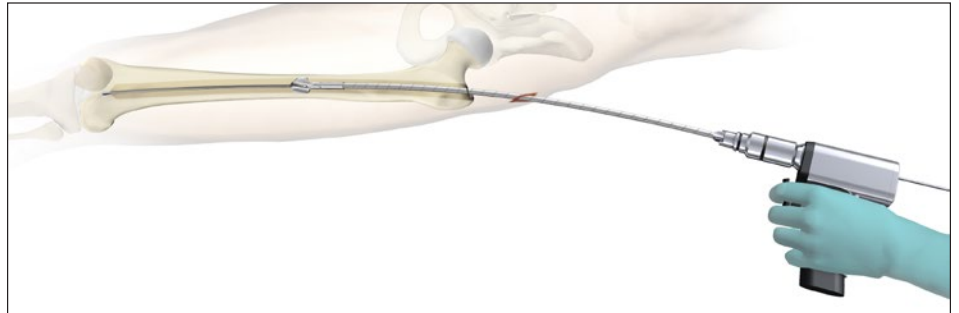

Fig. 39

CAUTION

For soft tissue protection, the Opening Sleeve should be used during reaming.

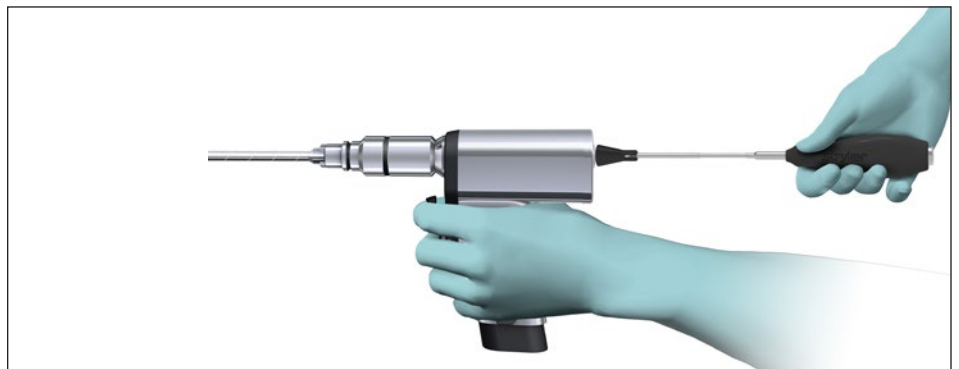

Fig. 40

WARNING

Care must be taken with reamers for the intramedullary canal. Ensure that:

- **the Guide Wire with ball tip is used**
- **the Guide Wire is correctly positioned (not advanced into the knee joint)**
- **the Guide Wire is not displaced laterally during reaming (could lead to an offset position for the nail and a higher risk of an iatrogenic fracture)**

Operative technique

Alternative 2: Opening Reamer

The Opening Reamer may be used to prepare the proximal canal of the femur (Fig. 41) to Ø15.5mm.

Without using power, the Opening Reamer is inserted through the Opening Sleeve and over the Guide Wire/pin until contact with bone. Once verified that the Opening Reamer and Opening Sleeve are fully seated on the bone, the Opening Reamer can be advanced carefully by using power. If hand powered reaming is preferred, attach the Quick-Lock Delta Handle and rotate the reamer assembly. The Opening Reamer hits a positive stop when the correct depth is reached. If a Precision Pin™ was used, it should now be replaced with a Guide Wire to facilitate implant insertion.

CAUTION
The Opening Reamer is a front and side cutting instrument and should be used with care to ensure that the sharp edges of the reamer do not inadvertently damage bone or soft tissue.

Ref #	Description
1420-0080	Opening Reamer
1420-0050	Opening Sleeve
2351-6000	Opening Reamer Handle
2351-0140	Quick-Lock Delta Handle (optional)

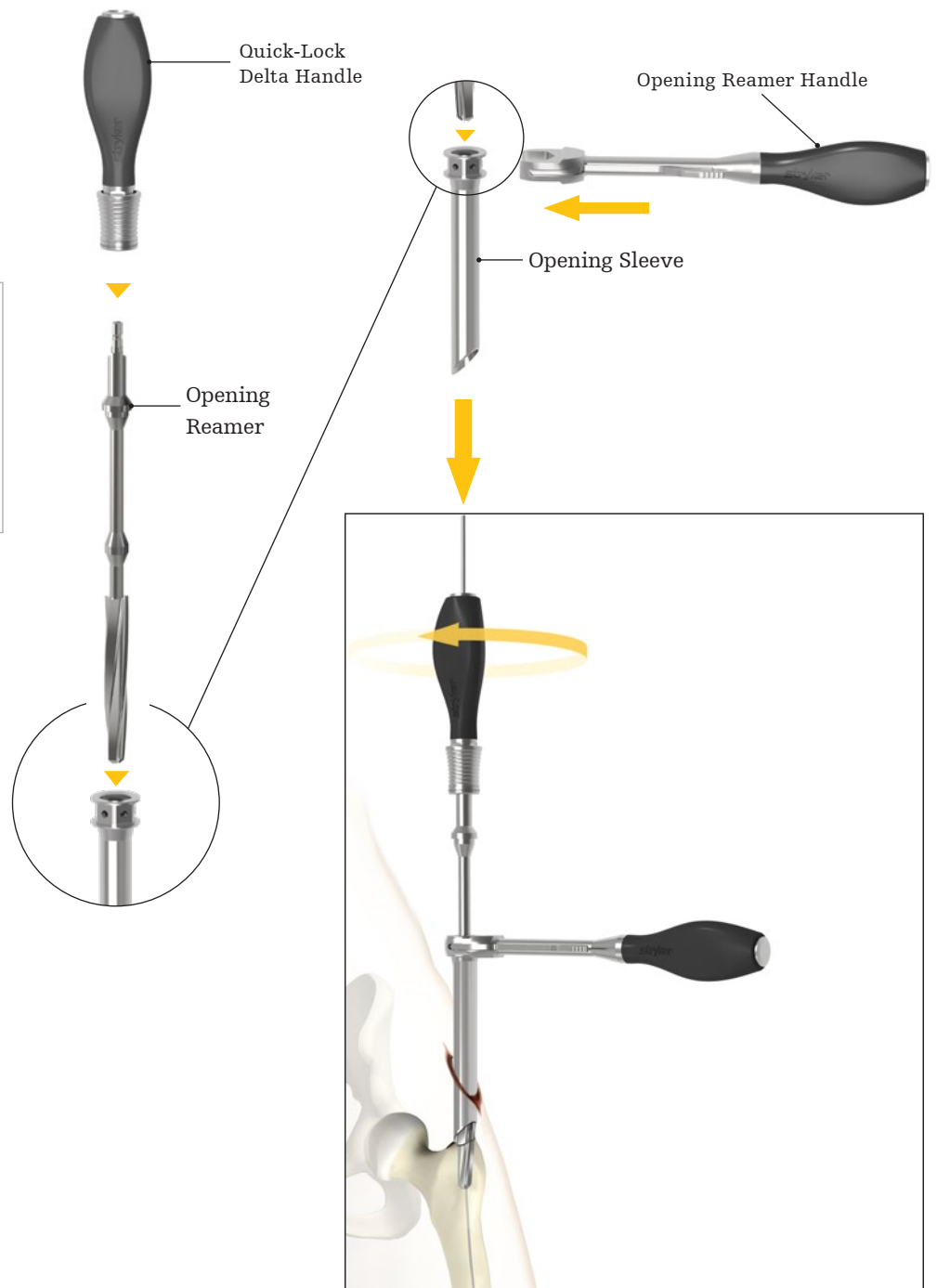

Fig. 41
23

Operative technique

Long Nail selection

Diameter

The diameter of the selected Gamma4 nail should be at least 1.5mm smaller than that of the last reamer used. The diameter may be determined by using the X-Ray Ruler at the smallest diameter of the medullary canal at the femoral isthmus under fluoroscopy (Fig. 42).

Length

Place the Guide Wire and read the correct nail length at the end of the Guide Wire on the Guide Wire Ruler (Fig. 43). Ensure that the tip of the Guide Wire Ruler is fully seated on the bone prior to determining the measurement. If the Guide Wire is between two length markings, use of the shorter nail is recommended.

As an alternative, the Guide Wire Ruler Tube may be used to obtain the implant length (Fig. 44a, 44b). The same steps and considerations as described above should be followed.

Ref #	Description
2351-0420	X-Ray Ruler
1806-0022	Guide Wire Ruler
2351-3100S	Guide Wire with Ruler Tube

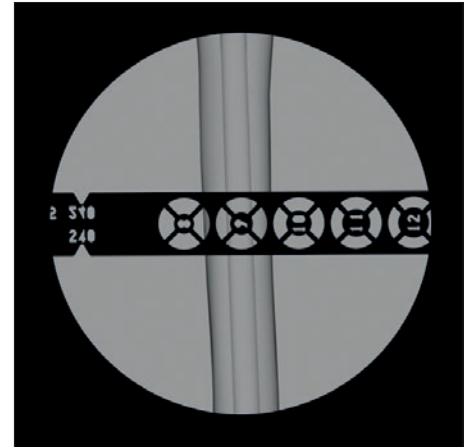
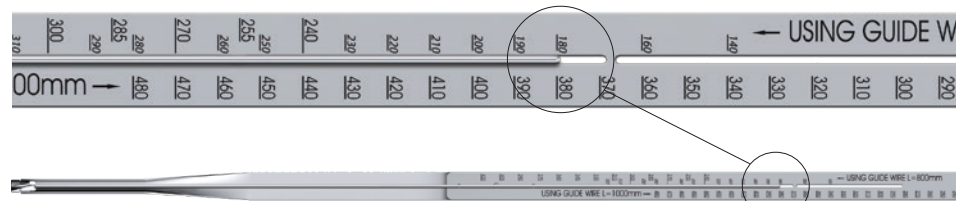

Image indicates an estimated canal diameter/width of 9mm.

Fig. 42

CAUTION

Ensure by fluoroscopy that curvature, length and diameter (at least 1.5mm smaller than reamer) of selected nail fits the patient's anatomy.



End of the Guide Wire Ruler is the measurement reference

Fig. 43

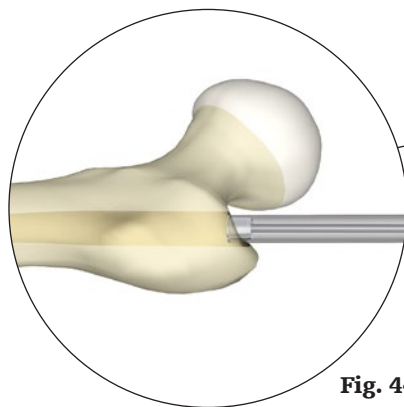

Fig. 44a

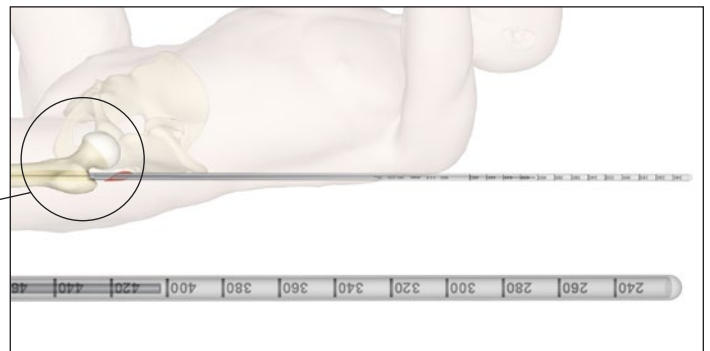

Fig. 44b

Operative technique

Targeting Arm

The targeting arm aids in placement of the implants and guidance of the instrumentation that facilitate the procedure.

The Gamma4 System offers two targeting arm options: Proximal Targeting Arm (Figure 45a) and Plus Targeting Arm (Figure 45b).

Ref #	Description
1420-0100	Proximal Targeting Arm
1420-0105	Nail Holding Screw
1420-0120	Plus Targeting Arm
1420-0125	Plus Nail Holding Screw

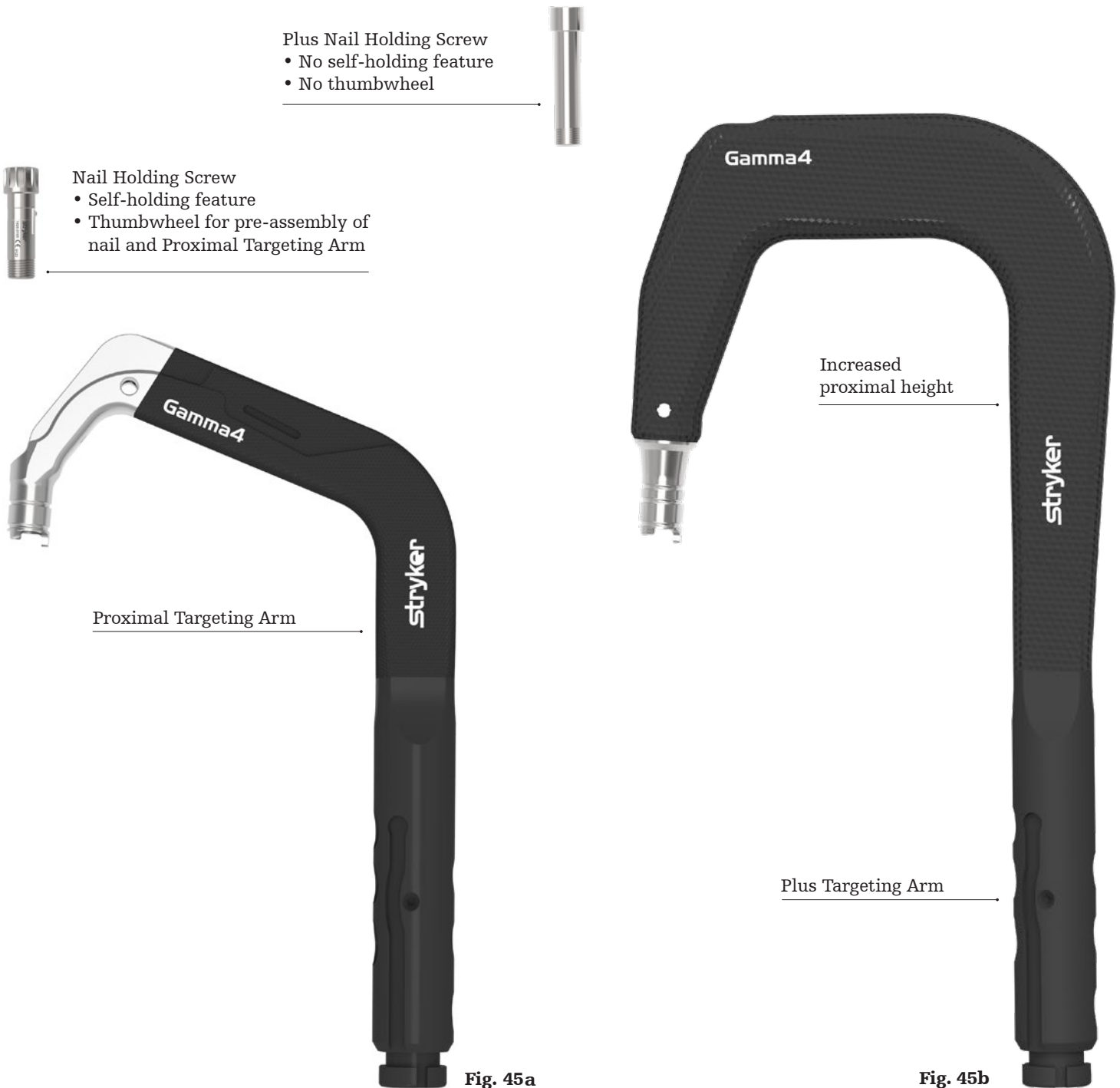

Operative technique

Proximal Targeting Arm assembly

1. Assembly of Proximal Targeting Arm and Targeting Sleeve

The Proximal Targeting Arm and Targeting Sleeve assembly (Fig. 46a-d) is designed to allow for guided Lag Screw locking of all nails and distal locking of Trochanteric Nails. For guided distal locking of long nails, refer to the 'Long Nail distal locking' section.

The Targeting Sleeve has two parts (sleeve and knob). These components are stored next to each other in two distinct spots of the tray. Without attaching the sleeve to the Proximal Targeting Arm, screw the knob clockwise past the point of increased resistance or fully tighten the knob to the sleeve (Fig. 46a). If fully tightened, carefully unscrew the knob until you meet resistance, which should occur when roughly half of the Targeting Sleeve threads are shown (Fig. 46b).

Now you may align the arrow of the Proximal Targeting Arm and Targeting Sleeve assembly, then push until you feel the magnetic connection (Fig. 46b). If assembled correctly, the Targeting Sleeve should provide resistance to rotation. If the Targeting Sleeve rotates without resistance, hold the Targeting Sleeve to the Proximal Targeting Arm and tighten the knob past the point of increased resistance.

To rotate the Targeting Sleeve to the desired neck-shaft (CCD) angle, push the Targeting Sleeve up (cranial) and rotate to the desired position (Fig. 46c). A click should be felt when you reach the desired position. At this point, the knob can be fully locked (clockwise) to prevent any loosening during nail insertion (Fig. 46d). For the Trochanteric Nail, the static or dynamic distal locking position is selected in the same way.

To unlock the Targeting Sleeve for insertion of the Lag Screw Sleeve, the knob has to be turned counter-clockwise until the increased resistance is felt.

Ref #	Description
1420-0110	Targeting Sleeve (2-part design)
2351-0040	Ball Tip Screwdriver
1420-0112	Targeting Sleeve Knob (spare part)

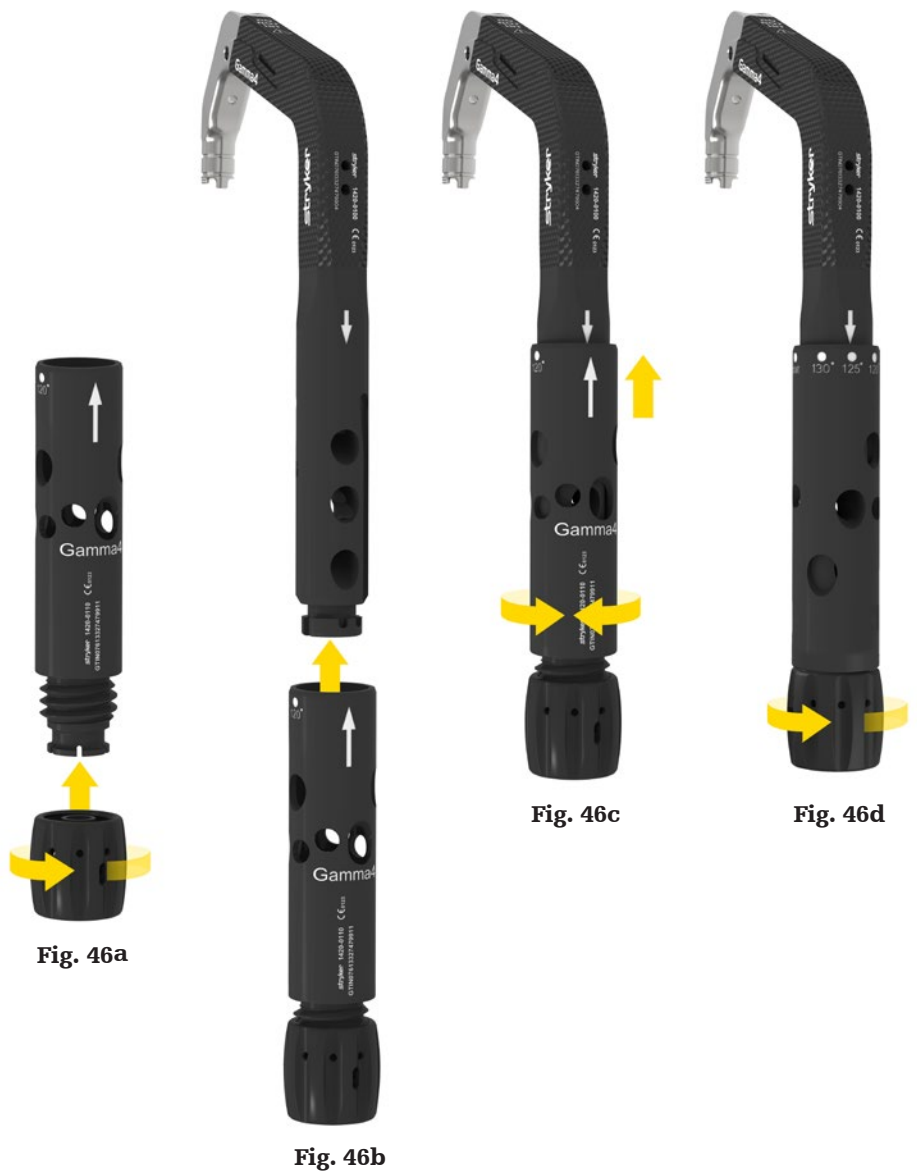

Operative technique

2. Assembly of Proximal Targeting Arm and nail

Insert the Nail Holding Screw into the Proximal Targeting Arm until a click is felt, this engages the self-retaining feature. Attach the nail and ensure that the Proximal Targeting Arm pins fit into the corresponding notches of the nail. The assembly may be pre-tightened by rotating the Nail Holding Screw by hand (Fig. 47). Use the Ball Tip Screwdriver to tighten the assembly until secured (Fig. 48).

CAUTION
 Fully tighten the Nail Holding Screw with the Ball Tip Screwdriver so that it does not loosen during nail insertion. Ensure that it is still fully tightened after nail insertion.

CAUTION
 There are two different types of nail holding screws available for the Proximal Targeting Arm and Plus Targeting Arm. Ensure to choose the correct nail holding screw to allow for proper assembly.



Fig. 47

Ref #	Description
1420-0100	Proximal Targeting Arm
1420-0105	Nail Holding Screw



Fig. 48

Operative technique

⚠ CAUTION

Ensure that the selected neck-shaft angle (CCD) matches the corresponding nail angle and distal locking configuration chosen.

Ensure the CCD angle matches the nail angle chosen by inserting the Lag Screw Sleeve and Lag Screw Reamer (Fig. 49). To perform this check, the knob of the Targeting Sleeve assembly must be unlocked (counterclockwise) to insert the instruments, and then locked (clockwise) to prevent mis-alignment. There should be no interference when passing the reamer through the nail.

These same steps should be followed to check that the correct distal locking configuration (static or dynamic) is chosen by using the corresponding sleeves and drills (Fig. 50).

Ref #	Description
1420-0160	Lag Screw Sleeve
1420-0240	Lag Screw Reamer
2351-0070	Tissue Protection Sleeve, Long
2351-4280	Locking Drill Sleeve, Long
2351-4236S	Locking Drill



Fig. 49



Fig. 50

Operative technique

Nail insertion

The nail is advanced through the entry point passing the fracture site until an appropriate Lag Screw position can be achieved (for details, refer to section 'Implant positioning' below). The Femoral Insertion Technology™ (aka FIT) of our nails includes a 5mm reduced proximal end, a beveled distal tip, as well as a length-dependent radius of curvature (Long Nails only) that is designed to facilitate nail insertion. The beveled distal tip is oriented in the M-L direction for Trochanteric Nails and the A-P direction for Long Nails.

Positioning of the nail should be carried out by hand (Fig. 51). If dense bone is encountered, first re-evaluate that sufficient reaming has been achieved, then, if necessary, the Strike Plate and/or Universal Rod can be attached to the Proximal Targeting Arm, or Final Impactor with Plus Targeting Arm and the Slotted Hammer may be used with caution for final positioning (Fig. 52a, Fig. 52b). The Nail Holding Screw should be re-tightened after hammering.

⚠ CAUTION

If the Slotted Hammer is used, please ensure that the Targeting Sleeve is locked (prevent loosening) and that the targeting arm is never struck (prevent breakage or deformation).

⚠ DANGER

The nail must progress smoothly, without excessive force. If too much resistance is encountered, removal of the nail and additional reaming is recommended.

Ref #	Description
2351-0060	Slotted Hammer (optional)
1806-0150	Strike Plate (optional)
1806-0110	Universal Rod (optional)
1320-0175	Final Impactor (optional)

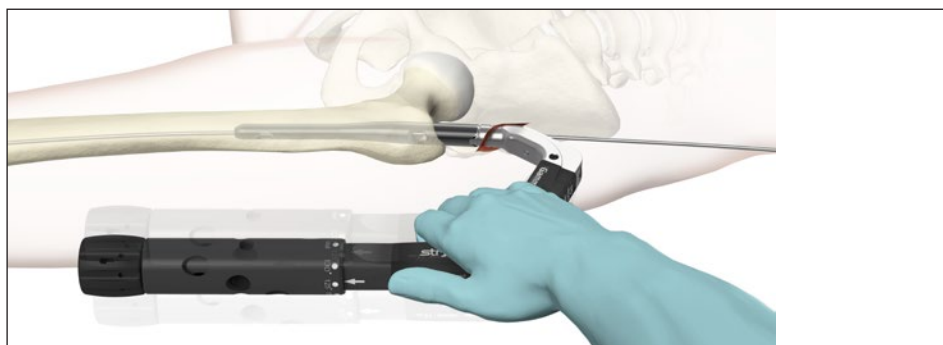

Fig. 51

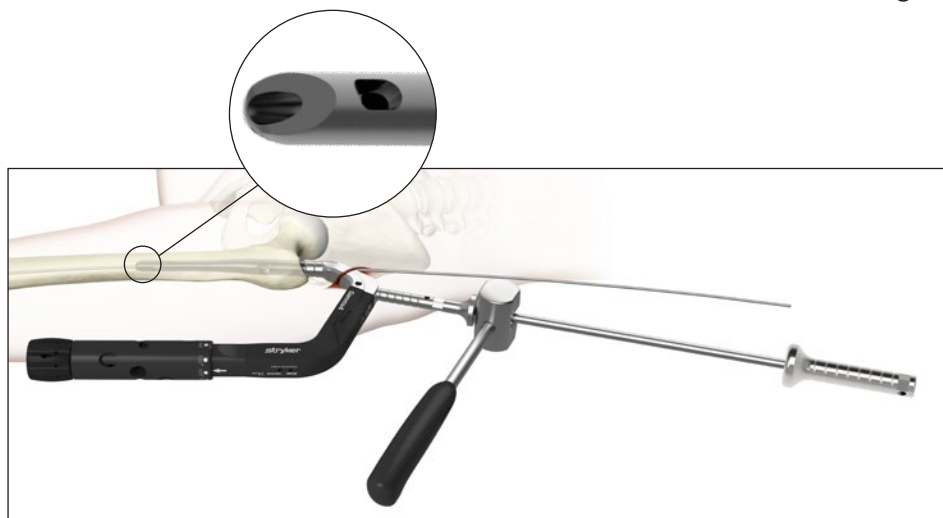

Fig. 52a



Fig. 52b

Operative technique

Implant positioning

Proper nail insertion depth and rotation ensures an optimal placement of the Lag Screw in the femoral head. The objective is to position the Lag Screw either in the center or slightly inferior in the femoral head in the A-P view and centrally in the lateral view.

Place the Lag Screw Sleeve up to the level of the skin and acquire an A-P X-ray image. To insert the sleeve, ensure that the Targeting Sleeve is unlocked. The Lag Screw Sleeve may be used to determine the optimal nail insertion depth (Fig. 53). Additionally, the Precision Pin™ may be inserted through the nail junction indication hole on the Proximal Targeting Arm (Fig. 54). This helps to identify the junction of the nail and insertion post so you may identify nail depth under X-ray.

Once satisfied with the nail depth, rotate the C-arm to the lateral position and acquire an X-ray image. A true lateral image can be achieved by orbital rotation of the C-arm, then ensuring on the X-ray image that the femoral neck axis is parallel to the proximal diaphysis. Tilting the fracture table may help with alignment. Rotate the Proximal Targeting Arm until the axis of the Proximal Targeting Arm and nail points towards the femoral head center (Fig. 55). The Precision Pin™ can be placed through the lateral indication hole in the Proximal Targeting Arm (Fig. 56). This may help with obtaining alignment under X-ray (Fig. 57). Place the pin with care to avoid soft tissue damage due to the sharp tip.

The One Shot Device may be used to help with alignment (refer to section 'Implant positioning with One Shot Device' below).

Ref #	Description	Dimensions
1420-0160	Lag Screw Sleeve	
1420-0060S	Precision Pin™	Ø3.9mm × 450mm
1420-0065S	Precision Pin™, tapered	Ø3.2/3.9mm × 450mm

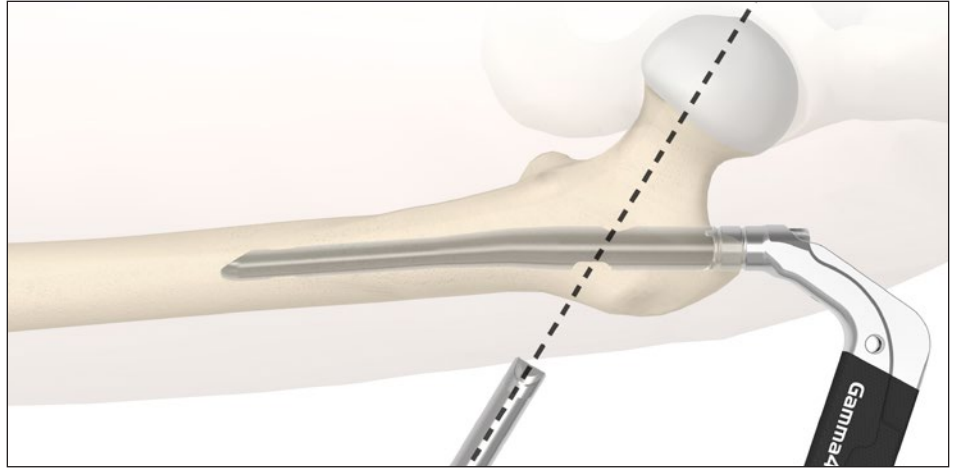

Fig. 53

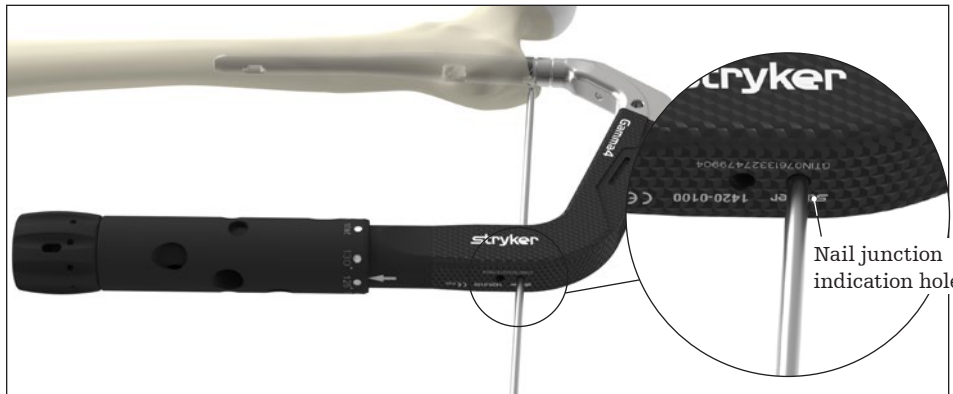

Fig. 54



Fig. 55

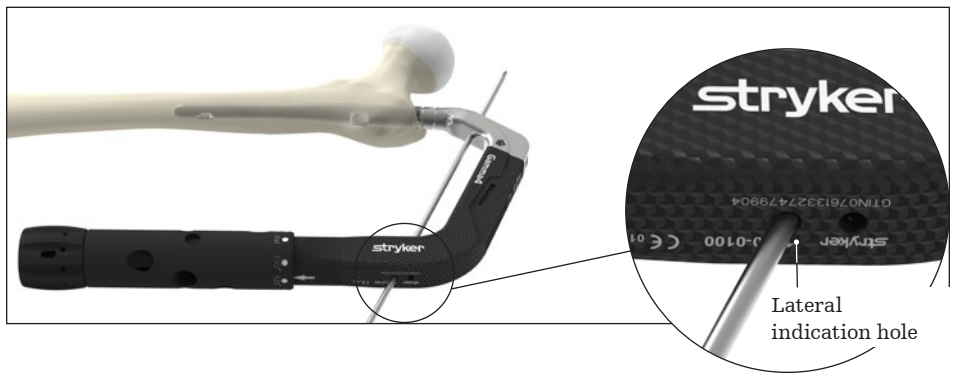

Fig. 56

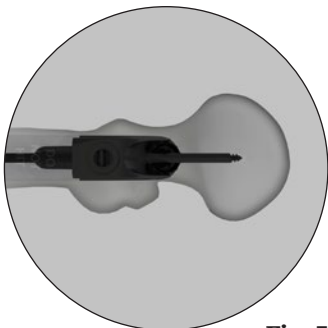

Fig. 57

Operative technique

Implant positioning with One Shot Device

The One Shot Device may be used to predict the Lag Screw position in both A-P and lateral views.

Prior to making an incision, it is attached to the Lag Screw Sleeve by pressing the clothes-pin mechanism and attaching to the sleeve (Fig. 58). The One Shot Device should be secured to the sleeve so it cannot translate but is able to rotate. Take an A-P image to confirm positioning of the One Shot Device.

If triangular shapes appear (Fig. 58a), rotate the One Shot Device around the Lag Screw Sleeve. The tips of the triangles indicate the direction the One Shot Device should be rotated. Once the triangles appear as solid lines on top of the dotted line, the trajectory of the Lag Screw is indicated (Fig. 58b). If the trajectory is not optimally positioned, adjust the placement of the nail until the trajectory is in the center of the femoral head or slightly inferior. The position can be adjusted by hand or by using the Strike Plate/Universal Rod and Slotted Hammer.

Rotate the C-arm and One Shot Device into a lateral position (Fig. 60). Independent from the C-arm and One Shot Device alignment, the first step should be to rotate the nail and Proximal Targeting Arm onto the plane of anteversion (Fig. 59a). Rotate the Proximal Targeting Arm until the dotted line of the One Shot Device is parallel to the femoral neck axis (Fig. 59b).

The One Shot Device is then rotated until the solid lines show up on top of the dotted line, which predicts the center line of the Lag Screw position (Fig. 59c). Rotate the Proximal Targeting Arm and repeat the aforementioned steps until a center position in the femoral head is achieved.

Ref #	Description
1420-0160	Lag Screw Sleeve
2351-0240	One Shot Device
2351-0060	Slotted Hammer (optional)
1806-0150	Strike Plate (optional)
1806-0110	Universal Rod (optional)



Fig. 58

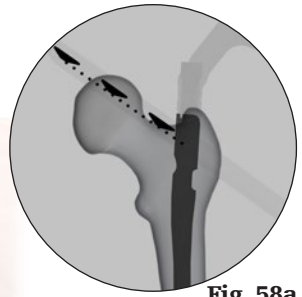

Fig. 58a

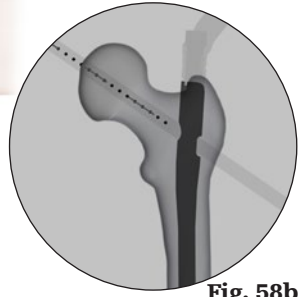

Fig. 58b

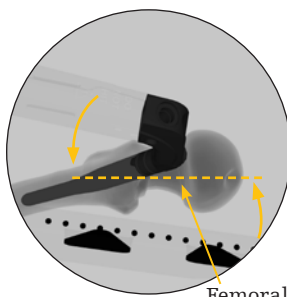

Fig. 59a

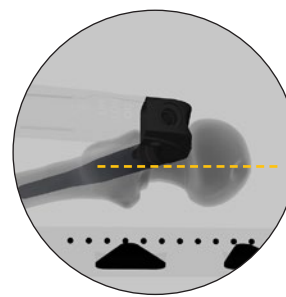

Fig. 59b

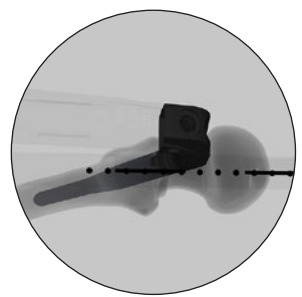

Fig. 59c

⚠ CAUTION

Prior to skin incision, check the position of the Lag Screw Sleeve and the projected trajectory of the Lag Screw (i.e. One Shot Device). If the position of the sleeve assembly has to be corrected afterwards, the tissue pressure may lead to mal-alignment and misdrilling.



Fig. 60

Operative technique

Sleeve insertion

The Proximal Targeting Arm may be held by an assistant to prevent its weight from externally rotating the nail until the next stage is completed.

Assemble the Lag Screw Sleeve with the Precision Sleeve™ and pass them through the Proximal Targeting Arm to the level of the skin. Mark the position and make the skin incision down to the bone (Fig. 61). Advance the sleeve assembly until it rests on the lateral cortex (Fig. 63).

The Lag Screw Sleeve/Precision Sleeve™ paddle tip (aka “half moon”) tip is designed to facilitate smooth insertion by rotating while simultaneously pushing the sleeves in. For accurate Lag Screw measurement, ensure the Lag Screw Sleeve is oriented so the sleeve head is parallel to the floor and locked in place by turning the knob of the Targeting Sleeve clockwise (Fig. 62).

The legacy Gamma3® Paddle Trocar may be used to aid in insertion. When the tip of the paddle trocar catches the fascia lata, twist it manually. There is a mark at the head of the Paddle Trocar that provides the direction of the tip.

Ref #	Description
1420-0160	Lag Screw Sleeve
1420-0220	Precision Sleeve™
2351-0390S	Locking Scalpel (optional)
1320-0133	Paddle Trocar (optional)



Fig. 61

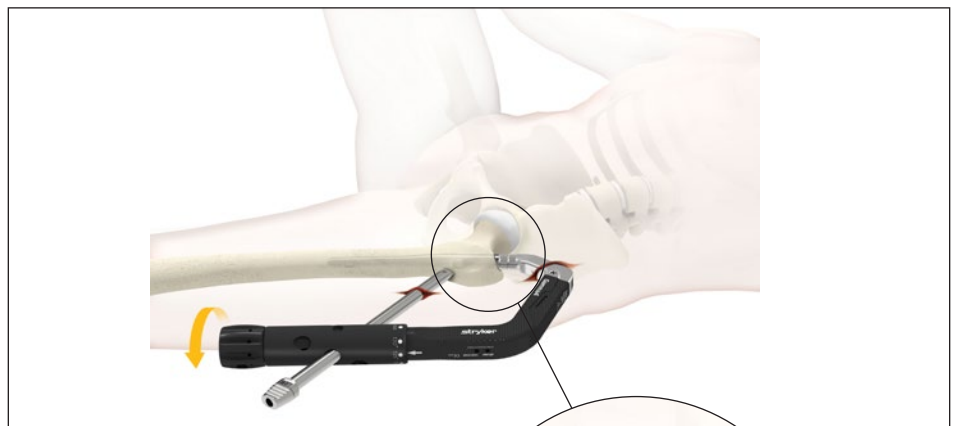

Fig. 62

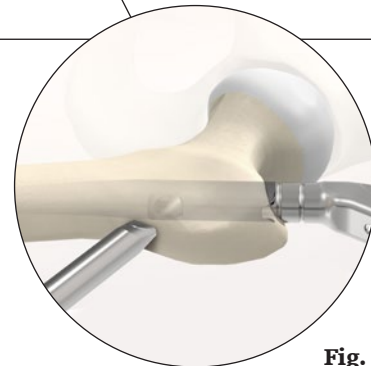

Fig. 63

NOTICE

Before proceeding, check that the Guide Wire with ball tip has been removed.

Operative technique

Anti-Rotation Clip

The Anti-Rotation Clip (Fig. 64) is designed to provide stability in rotationally unstable femoral head-neck fragments by temporary fixation of the femoral head fragment during reaming and Lag Screw insertion.

Assembly

Assemble the Anti-Rotation Clip with the open lever arm onto the inserted Lag Screw Sleeve (locked with Targeting Sleeve) and then onto the Proximal Targeting Arm (Fig. 65). A snap is felt if the Anti-Rotation Clip is placed correctly onto the Lag Screw Sleeve.

Make sure that the Anti-Rotation Clip is positioned in close contact with the Proximal Targeting Arm (Fig. 65). Close the lever arm firmly to stabilize the Anti-Rotation Clip (Fig. 66). Resistance is felt if the lever arm is in its final position.

Insertion of Anti-Rotation Sleeve

Advance the Anti-Rotation Sleeve through the appropriate hole (typically anterior) of the Anti-Rotation Clip (Fig. 67).

Pushing the Anti-Rotation Sleeve to the level of the skin may indicate the site for a small incision down to the bone.

The Anti-Rotation Sleeve is now advanced through the incision and should be firmly pushed against the cortical bone for proper anchorage and prevention of anterior displacement. The beveled tip of the Anti-Rotation Sleeve should be placed as shown in Fig. 67 (opening indicated by flat sleeve head).

Ref #	Description
1420-0190	Anti-Rotation Clip
1420-0192	Anti-Rotation Sleeve



Fig. 64



Fig. 65



Fig. 66

⚠ CAUTION

The pointed tip of the Anti-Rotation Sleeve should be rotated towards the center of the femur (Fig. 67) in order to support proper anchorage in the bone and guidance of the Precision Pin™.

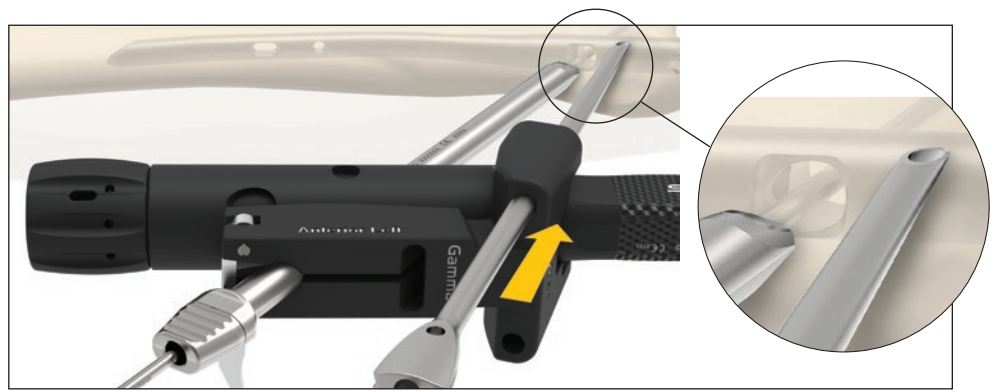

Fig. 67

Operative technique

Precision Pin™ placement

The Precision Pin™ is inserted through the cannulation of the Anti-Rotation Sleeve and should be placed within the femoral head to allow for stabilization of the head-neck fragment (Fig. 68, 69, 70). In order to prevent interference of the pin with the Lag Screw Reamer and/or Lag Screw, it is recommended to pass the fracture line with the pin just until sufficient bone fixation is achieved. For Lag Screw insertion, refer to sections 'Precision Pin™ placement', 'Lag Screw measurement', 'Lag Screw reaming' and 'Lag Screw insertion' below.

Removal of Anti-Rotation Clip

Remove the Precision Pin™ used for rotational control after Lag Screw fixation (and before compression takes place).

Remove the Anti-Rotation Sleeve (Fig. 71) and then remove the Anti-Rotation Clip by opening the lever arm (Fig. 72).

⚠ CAUTION

The Anti-Rotation Clip should only be used if the size of the femoral neck allows for Precision Pin™ insertion without penetrating the cortex of the femoral neck. To avoid damaging surrounding tissues it is recommended to only place the Precision Pin™ anteriorly.



Fig. 68



Fig. 69



Fig. 70



Fig. 71

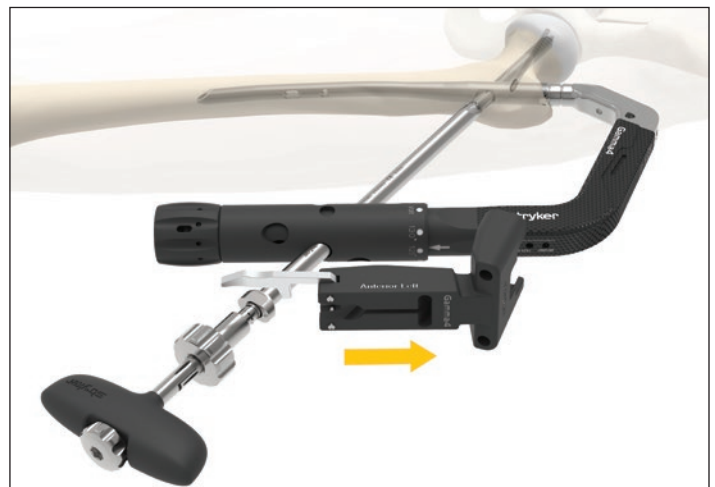

Fig. 72

Operative technique

Precision Pin™ placement

The Precision Pin™ is inserted through the Precision Sleeve™ and should be advanced to subchondral bone (Fig. 73) using the Guide Wire Handle or a power tool with a large collet (up to Ø4.0mm). Ensure that the Precision Pin™ is placed either center or slightly inferior in the A-P view and centrally in the lateral view (Fig. 74a, 74b) under X-ray monitoring.

The Precision Pin™, tapered can be used with the standard size collet (up to Ø3.2mm) due to the taper at the end of the pin (Fig. 75). The tapered pin has markings in 5mm increments (Fig 75a) which matches the drill-thread length (Fig 75b) and may be used for depth indication while inserting it to the subchondral bone. The Gamma4 pins are not compatible with the Gamma3® system (i.e. Lag Screw Reamer).

Ref #	Description	Dimensions
1420-0060S	Precision Pin™	Ø3.9mm × 450mm
1420-0065S	Precision Pin™, tapered	Ø3.2/3.9mm × 450mm
2351-0030	Guide Wire Handle (optional)	



Fig. 73

⚠ WARNING
 Ensure that the Precision Pin™ does not protrude into the pelvis which may damage large blood vessels or cause other serious injuries. Check the Precision Pin™ position with the image intensifier in both the A-P (center or slightly inferior) and M-L (center) views during Precision Pin™ placement, Lag Screw reaming and placement.

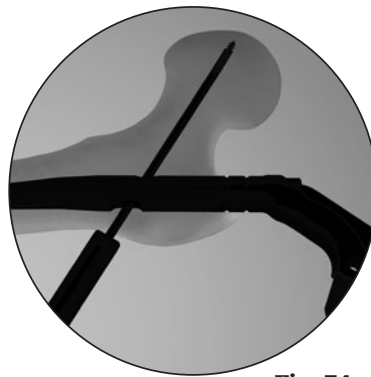

Fig. 74a

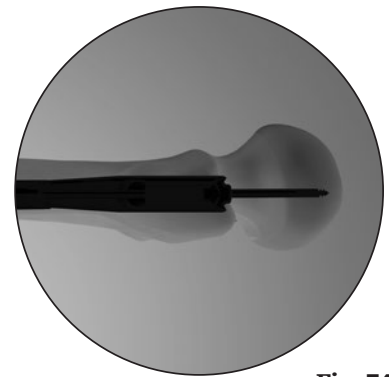

Fig. 74b

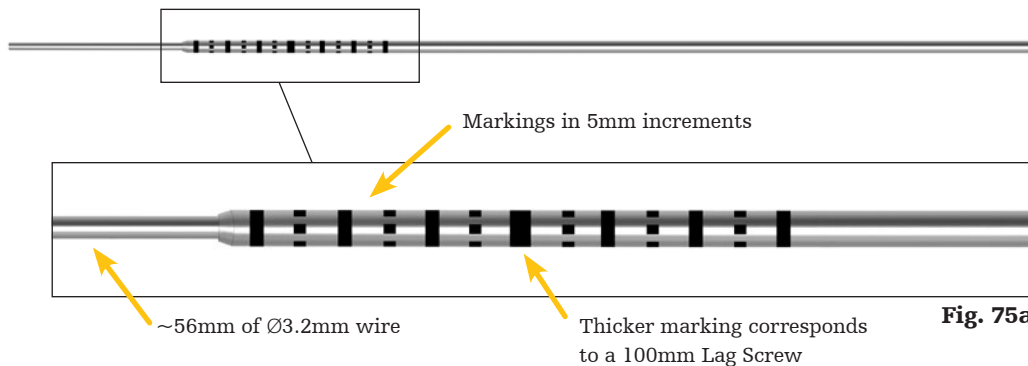

Fig. 75a

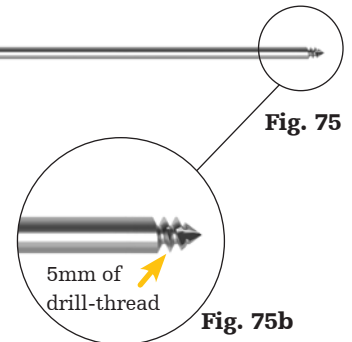

Fig. 75b

Operative technique

Lag Screw measurement

After satisfactorily positioning the Precision Pin™, the Lag Screw length is measured by rotating the head of the Precision Sleeve™ counter-clockwise and pulling it back until it is flush with the end of the Precision Pin™. For accurate measurement, ensure that the Precision Pin™ is not accidentally pushed inside of the sleeve and that the Lag Screw Sleeve is still pressed firmly against the lateral cortex of the femur (Fig. 76) with the “half moon” visible in the frontal plane.

Please note that the measurement technique has been changed from the legacy Gamma3® System. The scale measures from the tip of the Precision Pin™, as shown on the Precision Sleeve™ in Fig 78. It is recommended that the Lag Screw should be inserted to the base of the Precision Pin™ thread (5mm from tip). These 5mm should be taken into consideration when reading the measurement from the Precision Sleeve™ and choosing a Lag Screw size. In the example shown (Fig. 77, 78), a 100mm Lag Screw is inserted to the base of the Precision Pin™ thread.

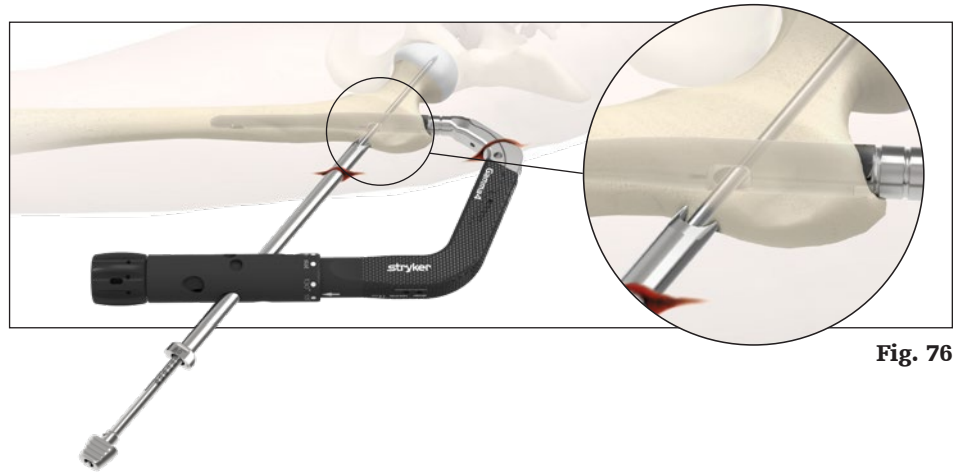

Fig. 76

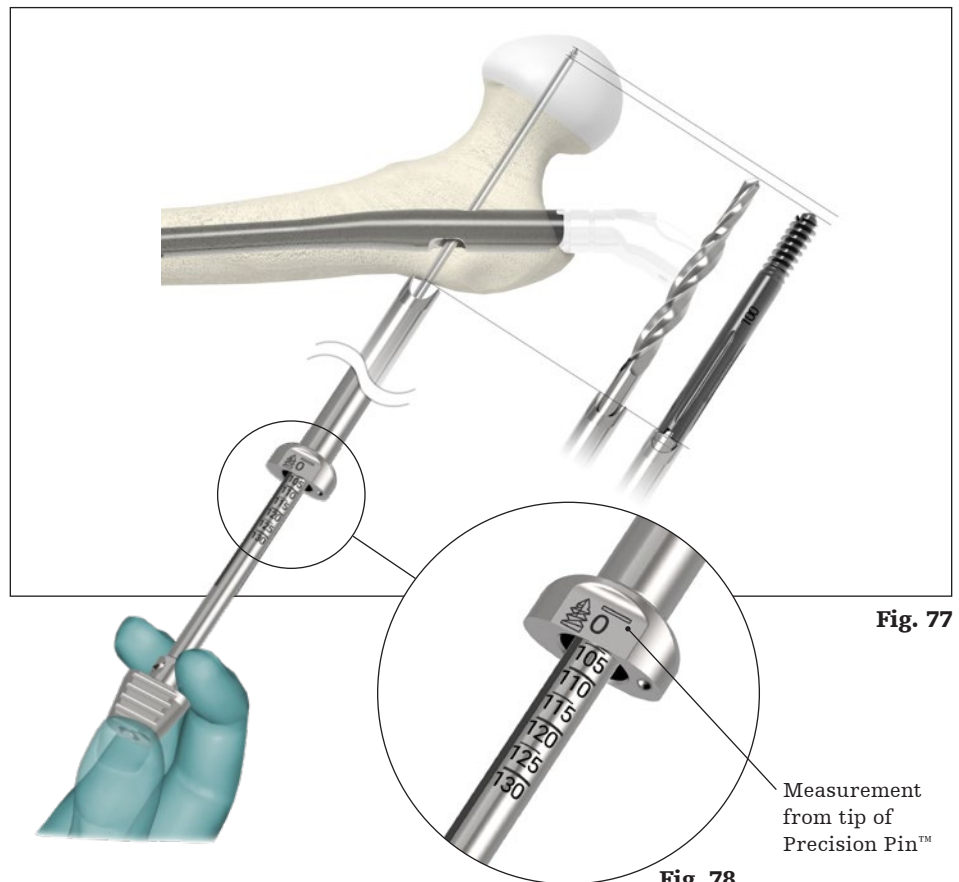

Fig. 77

Fig. 78

Measurement from tip of Precision Pin™

⚠ WARNING

The Precision Sleeve™ ruler measures from the tip of the Precision Pin™. Ensure that the Lag Screw Sleeve is in contact with the lateral cortex. Insufficient Lag Screw placement may lead to severe post-operative complications.

The pre-set drilling depth for the Lag Screw Reamer and the selection of the Lag Screw length should follow the recommendations for an optimal tip apex distance but still avoid subchondral cortex penetration. Lag screws are available in 5mm length increments. If compression/apposition is required, make sure to take the fracture gap into account as this will affect the measurement. For compression/apposition, refer to section 'Compression / apposition' below. If not taken into account, the Lag Screw may cause soft tissue irritation around the lateral cortex.

Operative technique

Lag Screw reaming

The value of the measurement is now transferred to the adjustable stop on the Lag Screw Reamer. The value (e.g. 100) must be visible in the window (Fig. 79).

The Precision Sleeve™ is now removed. The position of the Precision Pin™ inside the Lag Screw Sleeve may indicate rotational malalignment of the Proximal Targeting Arm. Center the Precision Pin™ in the Lag Screw Sleeve by rotating the Proximal Targeting Arm (Fig. 80). If malleting was performed, you may also check that the Nail Holding Screw is still fully tightened. If “chatter” is felt or heard during reaming, please check the position of the pin within the Lag Screw Sleeve (Fig. 80) and/or the position of the Precision Pin used for rotation control with the Anti-Rotation Clip.

The calibrated Lag Screw Reamer is passed over the Precision Pin™, through the Lag Screw Sleeve in order to prepare the lag screw channel (Fig. 81). Ensure that the knob of the Targeting Sleeve is still locked so the mechanical stop will prevent over-insertion of the Lag Screw Reamer (Fig. 81a). The window of the Lag Screw Reamer provides an additional method to check the Precision Pin™ end position (Fig. 81b). If following the pin placement and measurement technique described above, the 5mm thread should minimize bony build up which may allow for reamer removal without extraction of the pin. Additionally, instruments like the Guide Wire Pusher may be used to neutralize the pulling force on the pin (Fig 82).

If extremely strong bone is encountered, the Gamma3® Lag Screw Tap and T-Handle may be used with the Gamma3® K-Wire to allow for easier insertion. The selected length of the Lag Screw Reamer, the Lag Screw Tap and the Lag Screw should all be the same (in this example 100mm).

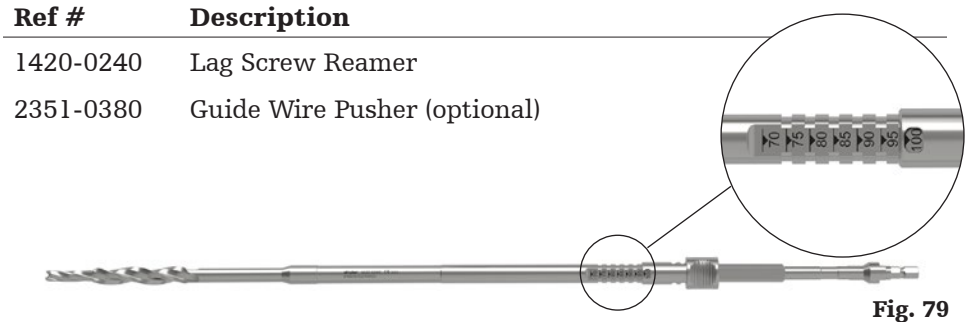

Fig. 79



Fig. 80

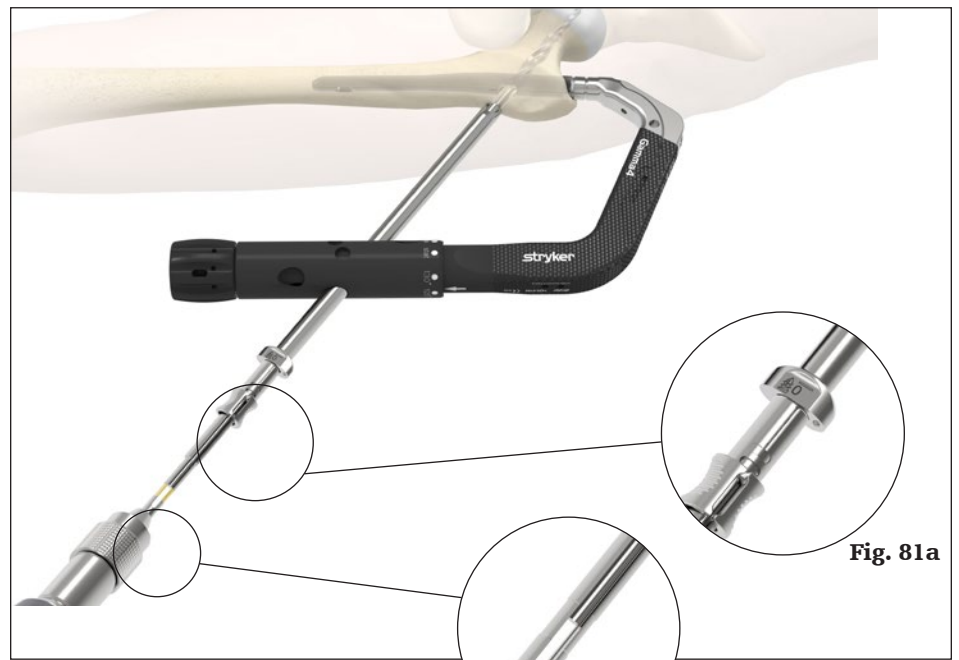

Fig. 81a

Fig. 81b

Fig. 81

⚠ WARNING

Additional reaming for corrections may compromise fixation of the Lag Screw.

⚠ WARNING

Ensure that the Precision Pin™ is centered within the Lag Screw Sleeve (Fig. 71) when reaming in order to avoid collision with the nail which may reduce the fatigue strength of the implant. The Lag Screw Reamer shall pass through the nail with ease.

⚠ WARNING

Observe the Precision Pin™ tip during drilling on the image intensifier. Avoid hip joint penetration and ensure that under no circumstances the Precision Pin™ or the Lag Screw Reamer is advanced into the pelvis, as this may cause serious injuries.

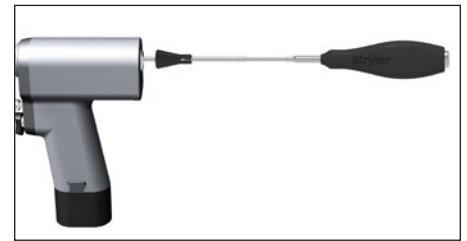

Fig. 82

Operative technique

Lag Screw insertion

The Lag Screw is then assembled to the Lag Screw Driver (Fig. 83).

Ensure that the pins of the Lag Screw Driver are in the slots of the Lag Screw (two assembly orientations, 180° rotation) (Fig. 83a) and the thread of the fixation rod is engaged inside the Lag Screw. Hand tighten the thumbwheel. The Ball Tip Screwdriver may be used to tighten the assembly.

The Lag Screw assembly is now passed over the Precision Pin™ and inserted to its desired position under X-ray monitoring (Fig. 84a). The indicator mark (solid black line) on the Lag Screw Driver shaft may help identify the final Lag Screw position during insertion (Fig. 84b).

The handle of the Lag Screw Driver must be parallel or perpendicular (for the Lag Screw) or perpendicular (90°) (for the RC Lag Screw) to the Proximal Targeting Arm to ensure that the set screw is able to fit into one of the four grooves of the Lag Screw or one of the two grooves of the RC Lag Screw (Fig. 85, Fig. 86).

The set screw alignment indicator will help to find the correct position of the handle (Fig. 84b).

Ref #	Description
1420-0260	Lag Screw Driver (3-part design)
2351-0040	Ball Tip Screwdriver

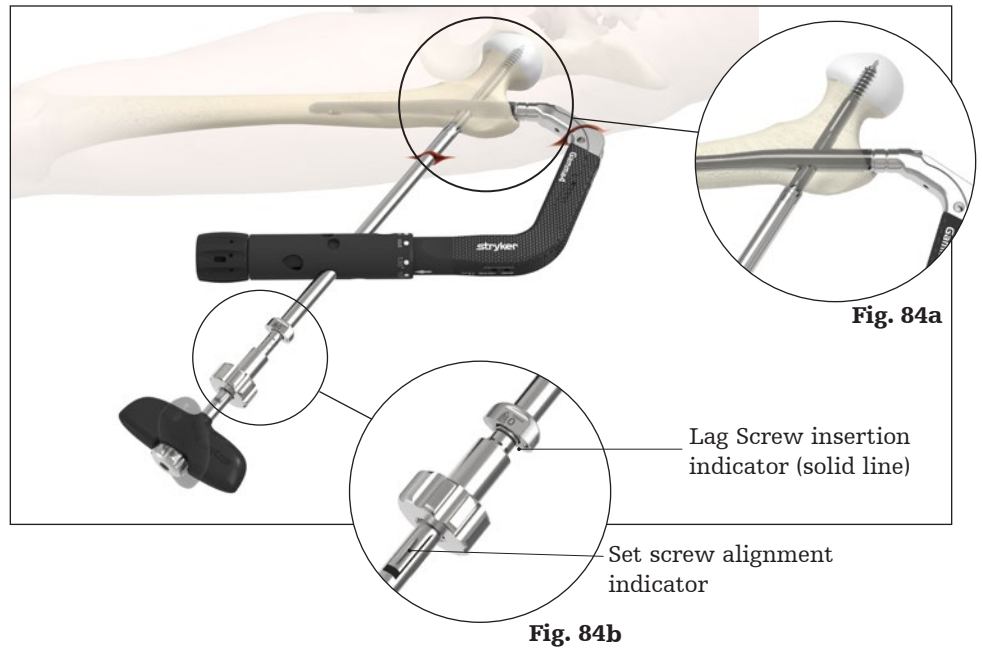
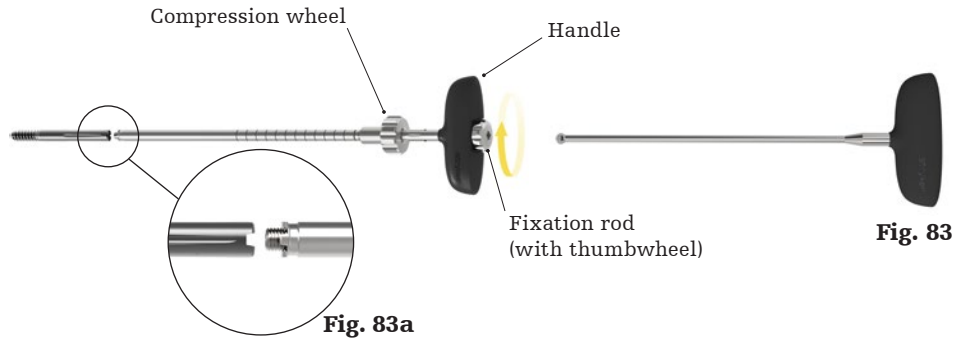

⚠ WARNING

Ensure that the Lag Screw, Precision Pin™ and femoral head fragment position is monitored under X-ray control. It is recommended to place the Lag Screw close to subchondral bone to provide maximum resistance against cut-out.

⚠ WARNING

Ensure that the Lag Screw Driver handle is parallel or perpendicular (90°) (for Lag Screw) and perpendicular (90°) (for RC Lag Screw) to the Proximal Targeting Arm. Take care during set screw insertion to avoid any implant damage, this may compromise implant performance.

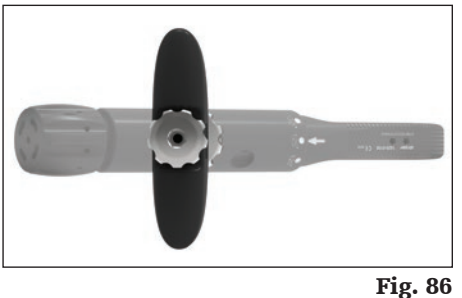
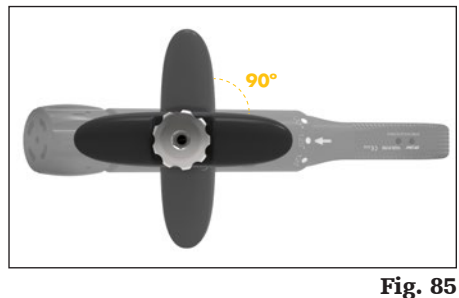

Operative technique

Compression / apposition

If compression or apposition of the fracture gap is required, this can be achieved by gently turning the compression wheel of the Lag Screw Driver clockwise against the Lag Screw Sleeve (Fig. 88, 89). To prevent migration of the Lag Screw Sleeve, ensure that the knob of the Targeting Sleeve is in the locked position (clockwise). A maximum of 15mm of compression is possible.

NOTICE

In case of compression, the Lag Screw length should be chosen shorter based on the expected amount of compression.

⚠ WARNING

To prevent Lag Screw pullout, take care when applying compression (especially in osteoporotic bone).



Fig. 87



Fig. 88

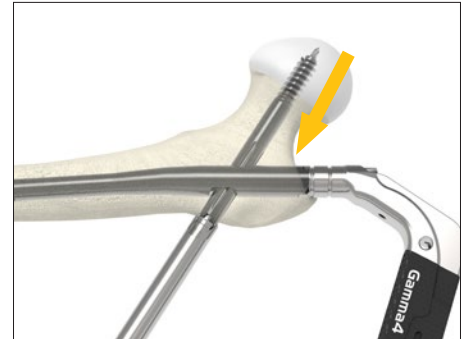

Fig. 89

Operative technique

RC Lag Screw

If additional rotational stability and fixation performance is desired, the RC Lag Screw may be used as an option.

RC Lag Screw insertion

Attach the RC Lag Screw (without the U-blade and U-blade end cap) to the Lag Screw Driver and tighten the thumbwheel (Fig. 90). The RC Lag Screw is now passed over the Precision Pin™ through the Lag Screw Sleeve and is placed in the desired position within the femoral head under X-ray visualization. A double check of the end position is also possible with the indicator ring (dotted line) on the Lag Screw Driver when it reaches the end of the Lag Screw Sleeve (Fig. 91). The design of the RC Lag Screw provides two set screw grooves (standard lag screw provides four). For correct RC Lag screw alignment, the handle of the Lag Screw Driver must be perpendicular to the Proximal Targeting Arm (Fig. 92). The U-blade laser markings at the set screw groove indicators must point towards caudal and cranial indicating the orientation of the U-blade in-situ.

Insert the set screw (refer to section 'Set screw fixation') before insertion of the U-blade.

If compression or apposition of the fracture gap is required, refer to the section 'Compression/apposition' above (occurs before U-blade insertion).

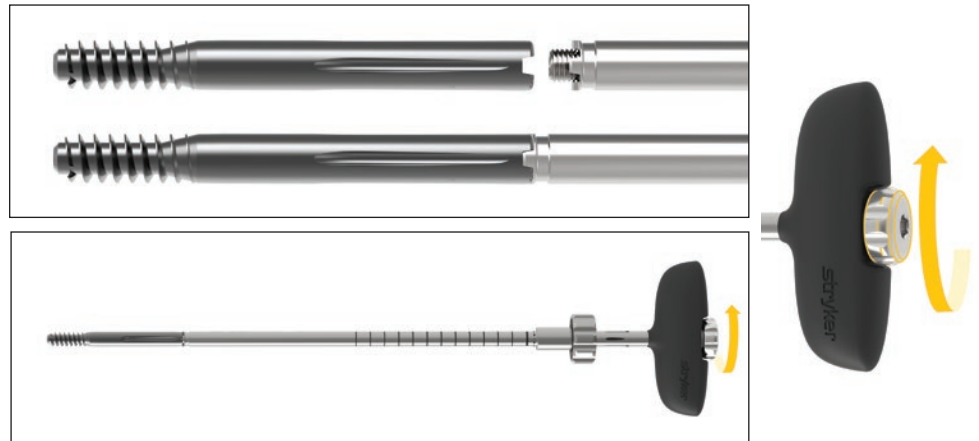

Fig. 90



Fig. 91

⚠ WARNING

In osteoporotic bone it is recommended to use the RC Lag Screw for additional migration resistance. The RC Lag Screw is also indicated for rotationally unstable fractures.

⚠ CAUTION

The set screw has to be placed before U-blade insertion.

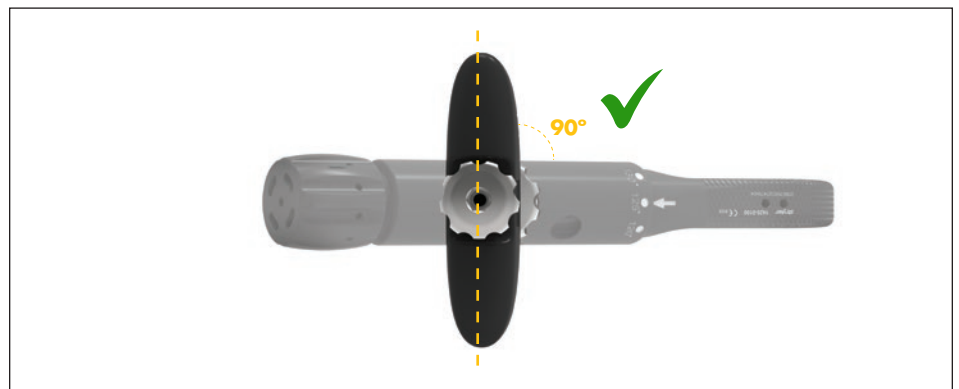

Fig. 92

Operative technique

U-Blade insertion

Before inserting the U-blade, disconnect the Lag Screw Driver from the RC Lag Screw by turning the thumbwheel counterclockwise. Remove the Lag Screw Driver and Precision Pin™.

Attach the RC Guide to the RC Lag Screw by turning the RC Guide clockwise by hand (Fig. 93a and 93b).

Connect the U-blade to the RC Inserter by turning the RC Inserter clockwise by hand (Fig. 94a and 94b).

Push the U-blade assembly gently over the RC Guide (Fig. 95) and into the flutes of the RC Lag Screw.

The insertion is done by hand until the U-blade spreads open and starts to contact the surrounding bone. At this point, the U-blade should be approximately 25mm away from its final position. Refer to Fig. 96a and 96b.

Use the Slotted Hammer and apply careful hammer strokes to the strike plate of the RC Inserter in order to insert the U-blade until its final position.

The final position of the U-blade is indicated when the indicator ring of the RC Guide is aligned with the indicator ring of the RC Inserter (Fig. 97).

A visual check with the image intensifier in the lateral view is recommended to confirm the U-blade's final position.

Remove the RC Inserter and RC Guide.

⚠ CAUTION

Take care during U-blade insertion with the hammer to avoid implant and/or bone damage. Observe the indicator rings of the RC Guide and RC Inserter to stop hammering when the U-blade is in its final position (indicator rings aligned).

⚠ CAUTION

Use the RC Guide for guidance of the U-blade to prevent damage of the U-blade and RC Lag Screw during insertion of the U-blade with the RC Inserter as well as to allow for U-blade depth indication (alignment of laser markings on RC Guide and RC Inserter).

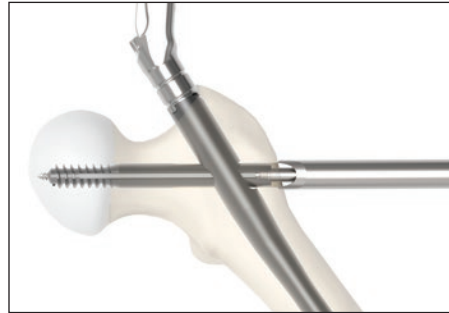

Fig. 93a

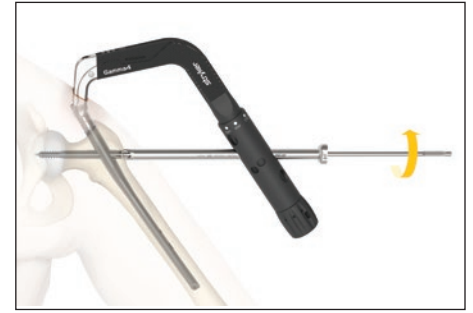

Fig. 93b



Fig. 94a

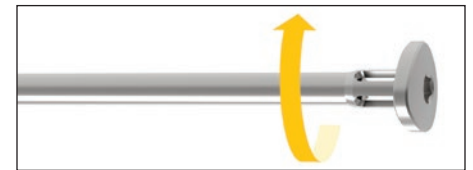

Fig. 94b

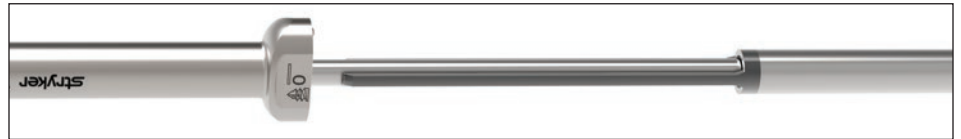

Fig. 95

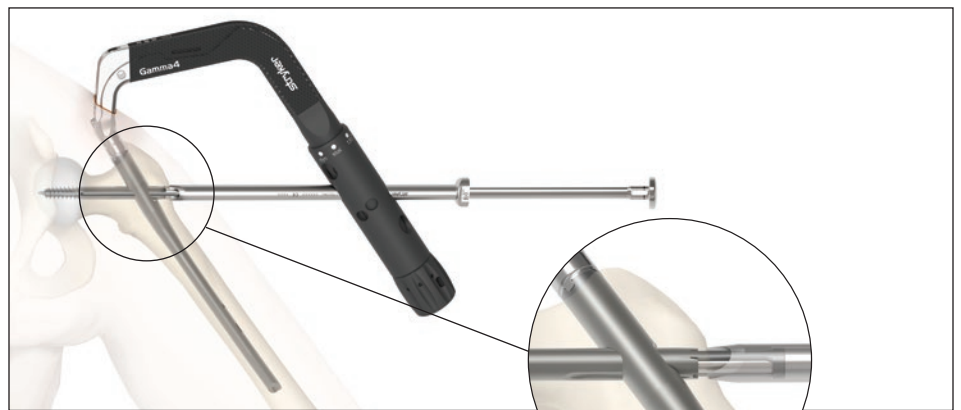

Fig. 96a

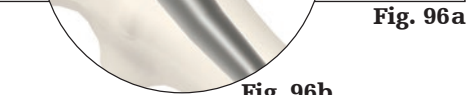

Fig. 96b



Fig. 97

⚠ CAUTION

Ensure the U-blade advances into the flutes of the Lag Screw and gently advance to final position to avoid breakage.

Operative technique

U-blade end cap Insertion

Insert the U-blade end cap through the Lag Screw Sleeve using the Set Screw Driver (Fig. 98a) and tighten firmly (Fig. 98b).

Remove the Set Screw Driver and the Lag Screw Sleeve (Fig. 99).

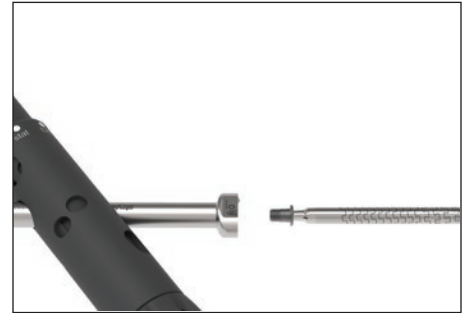

Fig. 98a



Fig. 98b

WARNING

Fixation of the U-blade is always completed by securely fastening the U-blade end cap into the RC Lag Screw. Omitting the end cap or insufficient fixation may lead to loss of fixation and post-operative complications.



Fig. 99

Operative technique

Set screw fixation

WARNING

The set screw must be used. Insufficient set screw placement could lead to loss of Lag Screw fixation and post-operative complications.

Connect the Set Screw Driver to the Quick-Lock Delta Handle (Fig. 100). Insert the Set Screw Driver through the Nail Holding Screw and into the nail until it engages with the preinserted set screw (Fig. 101). The ADAPT Clip may be used to facilitate insertion of the Set Screw Driver (the ADAPT Clip is not compatible with the Plus Targeting Arm).

Turn the Set Screw Driver clockwise. You may notice resistance during insertion due to the self-retaining feature of the set screw thread. Keep turning until you feel contact in one of the grooves of the Lag Screw (Fig 102).

Ref #	Description
2351-0140	Quick-Lock Delta Handle
1420-0270	Set Screw Driver
1320-0234	Set Screwdriver, Flexible (optional)



Fig. 100

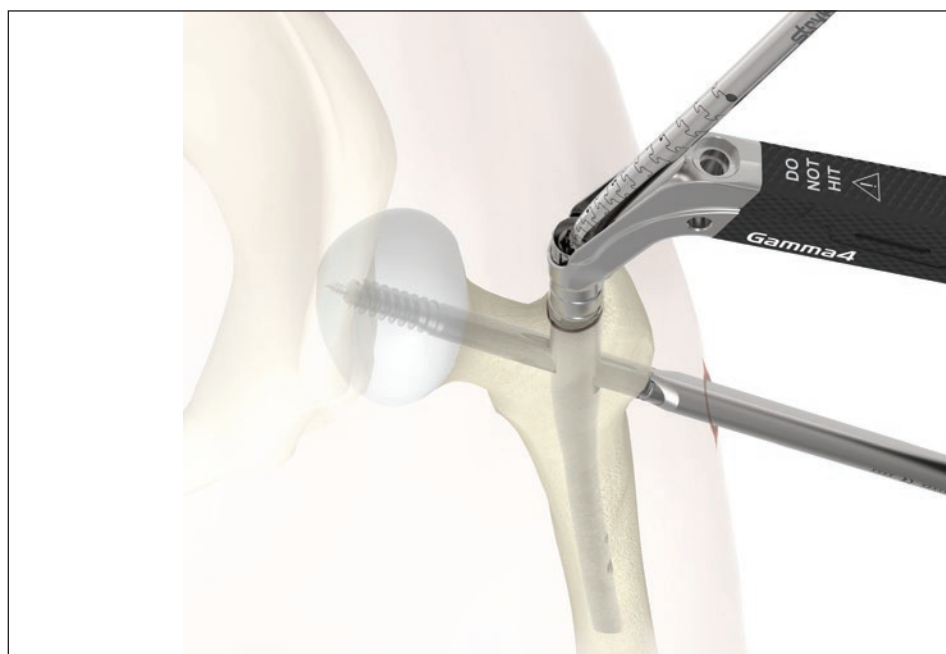

Fig. 101



Fig. 102

Operative technique

To verify the correct position of the set screw, try to turn the Lag Screw Driver (Fig. 103). It is not possible to turn the Lag Screw Driver if the set screw is engaged with the Lag Screw groove.

After tightening the set screw, unscrew the set screw by no more than a quarter (1/4) of a turn, until a small amount of rotation can be felt at the Lag Screw Driver (Fig. 104). This ensures controlled subsidence of the proximal fragment while still preventing medial migration of the Lag Screw.

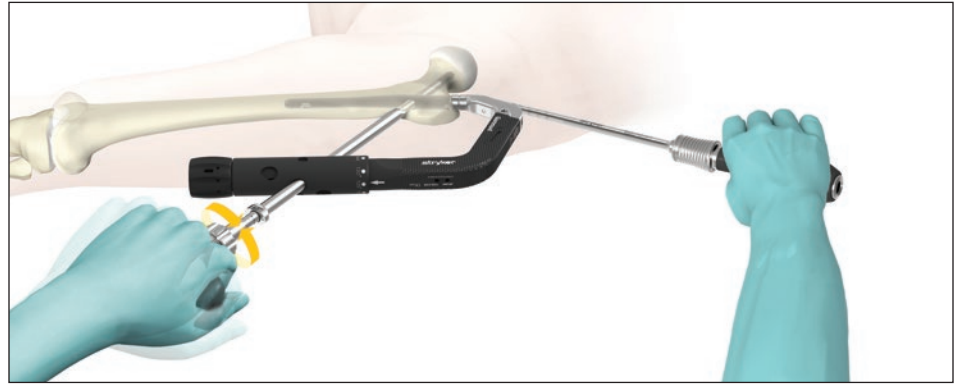

Fig. 103

WARNING

Do not unscrew the set screw more than 1/4 of a turn. Insufficient contact between Lag Screw and set screw could lead to loss of fixation and post-operative complications.

Remove the Lag Screw Driver, Precision Pin™ and Lag Screw Sleeve.

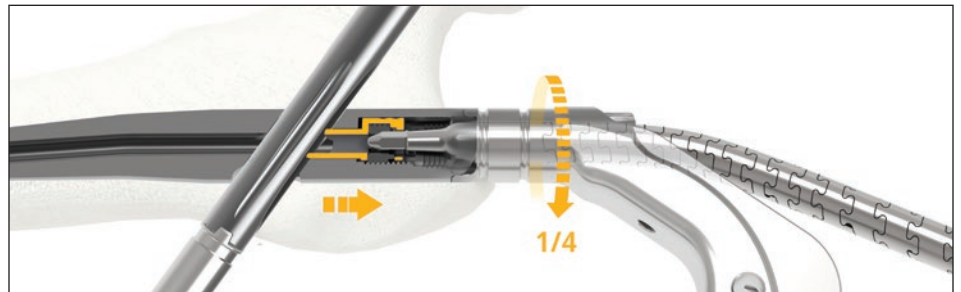

Fig. 104

Operative technique

Guided locking

Trochanteric Nail distal locking

Trochanteric Nails offer the possibility to be locked distally in a dynamic or static position (Fig. 105).

The knob of the Targeting Sleeve must be unlocked (counter-clockwise) until resistance is felt to allow for rotation of the Targeting Sleeve to the static or dynamic position. Push upwards (cranial) and rotate the Targeting Sleeve to the desired locking position.

For more instructions, please refer to section 'Proximal Targeting Arm assembly'.

The Tissue Protection Sleeve together with the Locking Drill Sleeve and Locking Trocar are positioned through the appropriate hole in the targeting assembly (Fig. 106).

⚠ CAUTION

Ensure that the incision through the fascia lata matches the sleeve axis (collinear) to avoid soft tissue pressure on the sleeve.

Make a small skin incision at the sleeve entry point, down to the lateral cortex and advance the assembly through the incision until contact is made with the lateral cortex.

If using the Locking Scalpel, push the sleeve assembly against the skin to leave a mark (Fig. 106), remove the sleeves and insert the scalpel through the appropriate hole of the targeting assembly and make an incision to accommodate the path of the sleeves (Fig. 107).

Ref #	Description
2351-0070	Tissue Protection Sleeve, Long
2351-4280	Locking Drill Sleeve, Long
2351-4290	Locking Trocar, Long
2351-4236S	Locking Drill
2351-0110	Screwdriver Bit, Long
2351-0140	Quick-Lock Delta Handle
2351-0390S	Locking Scalpel (optional)
2351-0150	Guided Depth Gauge (optional)

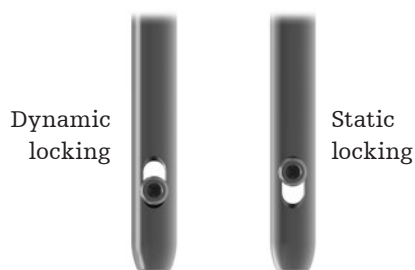

Fig. 105

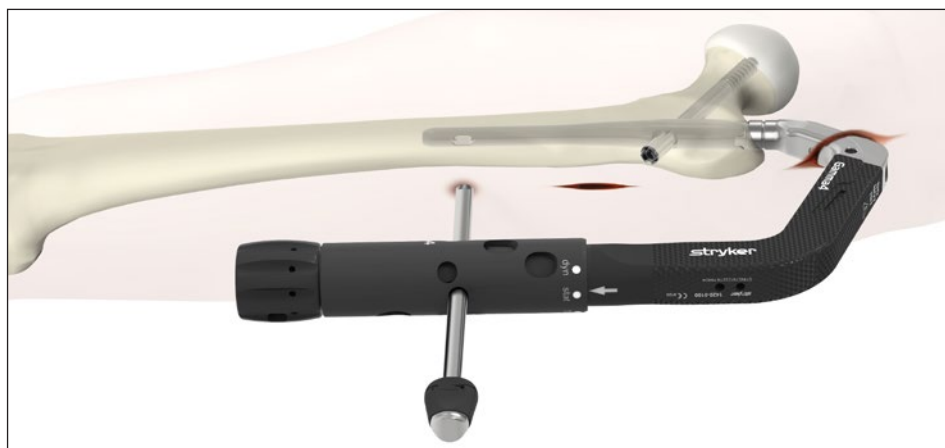

Fig. 106

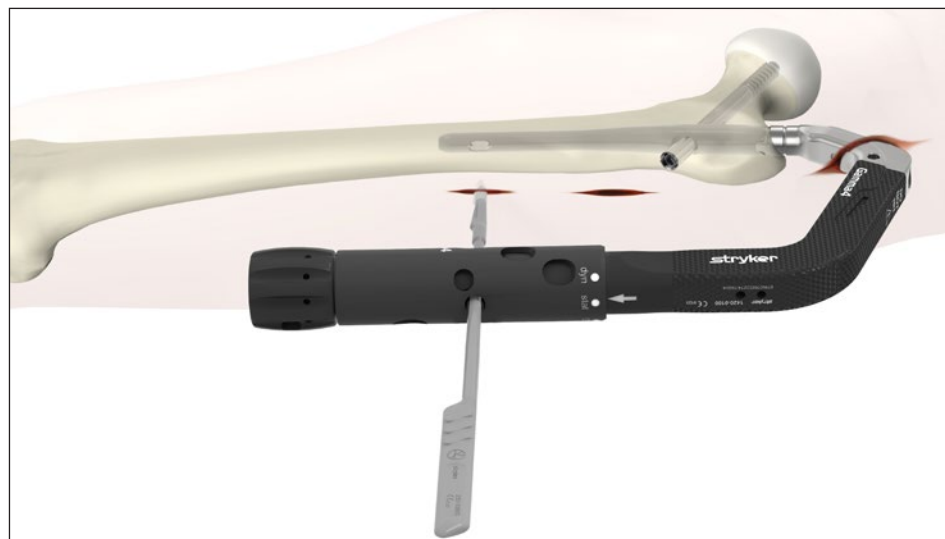

Fig. 107

Operative technique

As soon as the Tissue Protection Sleeve is fully seated on the cortex, the head of the trocar will pop out from the sleeve assembly (Fig. 108a).

Remove the trocar and ensure that the paddle tip of the Tissue Protection Sleeve is positioned in the frontal plane and is fully seated on the bone (Fig. 108b).

Advance the Ø4.2 x 360mm Locking Drill through the Locking Drill Sleeve and onto the lateral cortex (Fig. 109). Drill until the medial cortex is reached. Determine the length measurement by rotating the grip of the Locking Drill Sleeve and pulling the sleeve towards the drill attachment until the sleeve hits the stop. Read the measurement on the Locking Drill Sleeve at the end of the Tissue Protection Sleeve and add the thickness of the medial cortex (Fig. 110). Then drill through the medial cortex.

Alternative:

The Guided Depth Gauge can be used through the Tissue Protection Sleeve to read off the length at the end of the sleeve (Fig. 111).

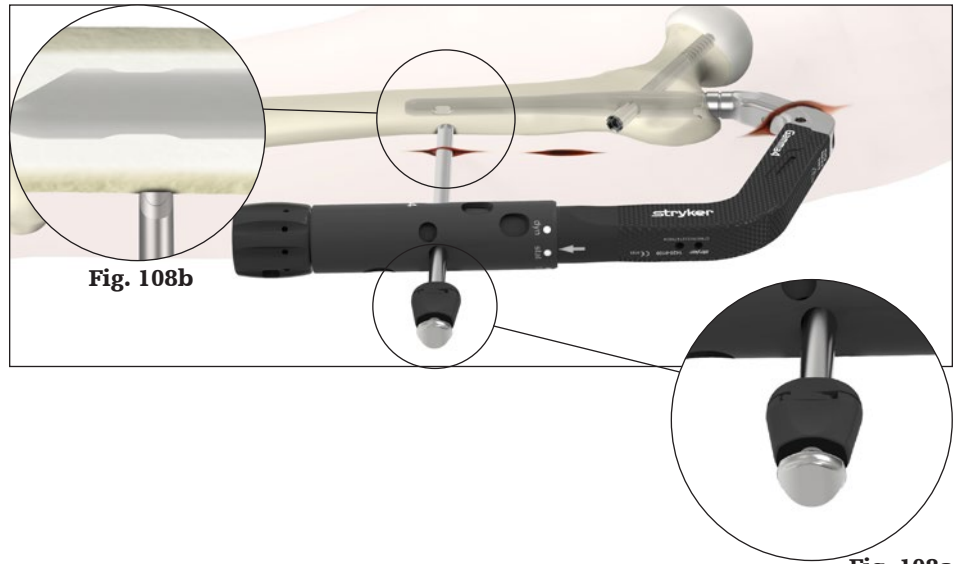

Fig. 108b

Fig. 108a



Fig. 109



Fig. 110



Fig. 111

⚠ CAUTION

The following points must be considered during drilling:

- Ensure that the Tissue Protection Sleeve is placed on the lateral cortex for correct measurement and to protect the soft tissue properly
- Neutralize the power tool weight during drilling and do not apply force to the Proximal Targeting Arm
- Start the power tool before having bone contact with the drill

⚠ WARNING

Take care during drilling to avoid any unintended soft tissue damage beyond the medial cortex.

Operative technique

Remove the Locking Drill and Locking Drill Sleeve and insert the selected screw through the Tissue Protection Sleeve using the Screwdriver Bit and Quick-Lock Delta Handle (Fig. 112).

Advance the screw through both cortices until the screw is fully seated. When the marking on the screwdriver (Locking Screw insertion indicator) nears the end of the Tissue Protection Sleeve the screw is close to its final position (Fig. 113). Use imaging to confirm placement of the screw.

The paddle tip of the sleeve allows the user to visually verify that the screw head is seated on the bone under X-ray (Fig. 114).

Fig. 112

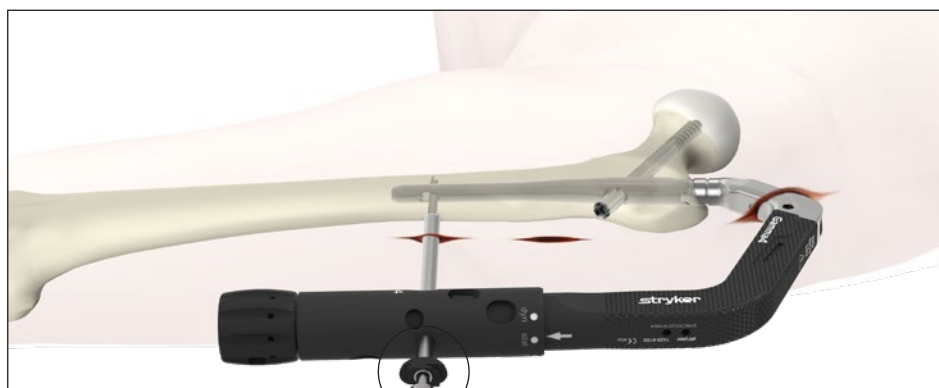

CAUTION

Take care not to strip the threads in the bone by over tightening.

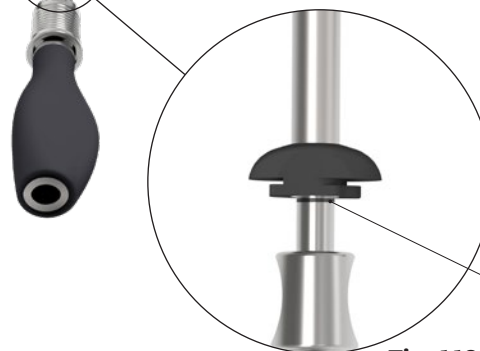

Locking Screw insertion indicator

Fig. 113

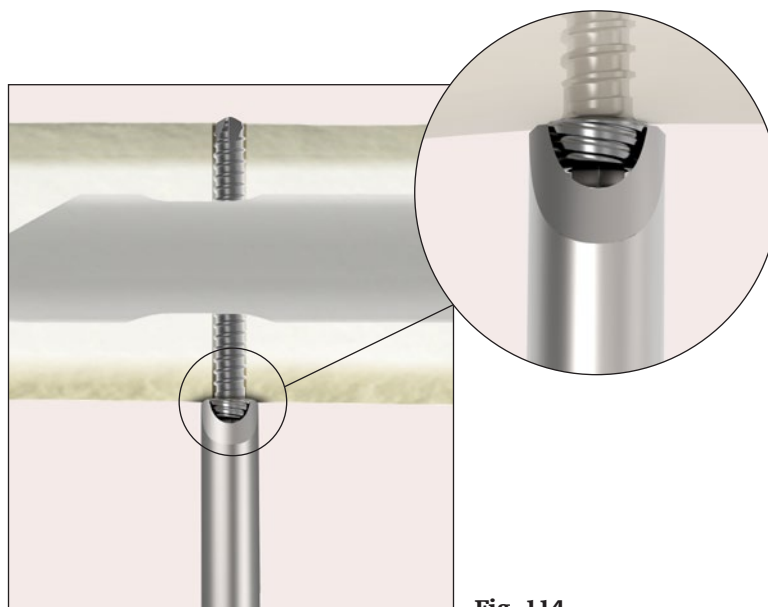

Fig. 114

Operative technique

Intermediate Nail distal locking

Intermediate Nails offer distal locking with a round and an oblong hole (Fig. 115)

Ref #	Description
1420-3100	Intermediate Targeting Sleeve
2351-0070	Tissue Protection Sleeve, Long
2351-4280	Locking Drill Sleeve, Long
2351-4290	Locking Trocar, Long
2351-4236S	Locking Drill
2351-0110	Screwdriver Bit, Long
2351-0140	Quick-Lock Delta Handle
1210-6451S	K-Wire (optional)
2351-0390S	Locking Scalpel (optional)
2351-0150	Guided Depth Gauge (optional)



Fig. 115

Operative technique

Assembly of Intermediate Targeting Sleeve

For distal locking of the Intermediate Nail, a dedicated Intermediate Targeting Sleeve is required (Fig. 116).

First, disassemble the Targeting Sleeve by releasing the knob, aligning the arrows of the Proximal Targeting Arm and Targeting Sleeve and pulling (Fig. 117).

Then, assemble the Intermediate Targeting Sleeve on the Proximal Targeting Arm (Fig 118). A click will be felt when the Intermediate Targeting Sleeve is correctly positioned.

Tighten the fixation knob clockwise to secure (Fig. 119).



Fig. 116

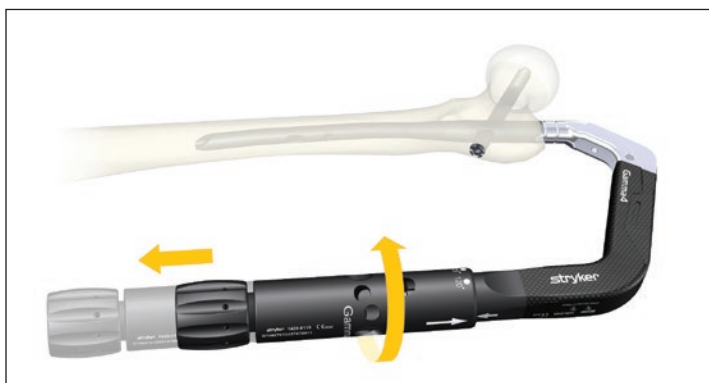

Fig. 117



Fig. 118

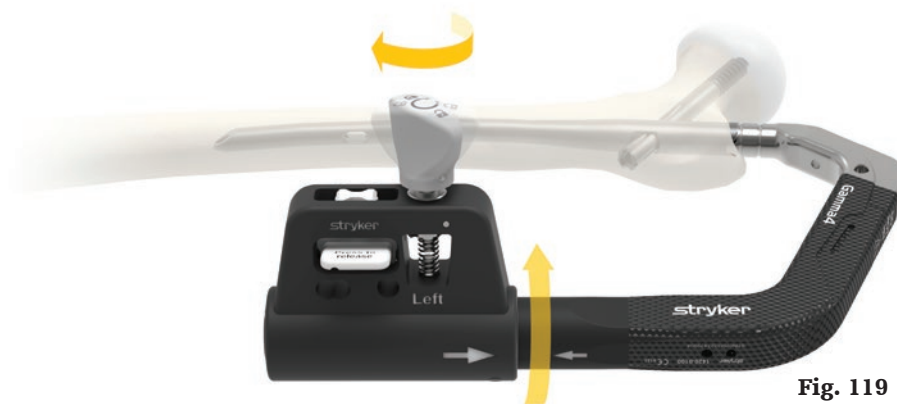

Fig. 119

Operative technique

Locking

Insert the triple sleeve assembly into the Intermediate Targeting Sleeve and push to mark the skin (Fig. 120).

Incise the skin at the sleeve entry point. The Locking Scalpel can be passed through the Intermediate Targeting Sleeve to make the incision. Ensure that the incision is straight and avoids placing forces on the sleeve.

Advance the sleeve assembly through the incision until contact is made with the lateral cortex.

For a detailed description of how to make the incision, measure the length of the locking screw and insert the screw please refer to section 'Trochanteric Nail distal locking'.

⚠ CAUTION

Use the Intermediate Targeting Sleeve for distal locking of the Intermediate Nail. Do not use the Targeting Sleeve used for Lag Screw placement.



Fig. 120



Fig. 121



Fig. 122

Operative technique

Disassembly

Press the sleeve fixation lever and remove the Tissue Protection Sleeve.

Open the fixation knob of the Intermediate Targeting Sleeve and remove it from the Proximal Targeting Arm (Fig. 123).

Complete the surgery with the End Cap insertion (refer to section 'End Cap insertion').



Fig. 123

Operative technique

Long Nail distal locking

Introduction

Use of the Distal Targeting System is recommended when performing distal locking of Gamma4 Long Nails.

Ref #	Description
2356-0680	IM Nailing Femur Antegrade Distal Targeting Kit
2351-0070	Tissue Protection Sleeve, Long
2351-4280	Locking Drill Sleeve, Long
2351-4290	Locking Trocar, Long
2351-4236S	Locking Drill
2351-0110	Screwdriver Bit, Long
2351-0140	Quick-Lock Delta Handle
1210-6451S	K-Wire (optional)
2351-0390S	Locking Scalpel (optional)
2351-0150	Guided Depth Gauge (optional)

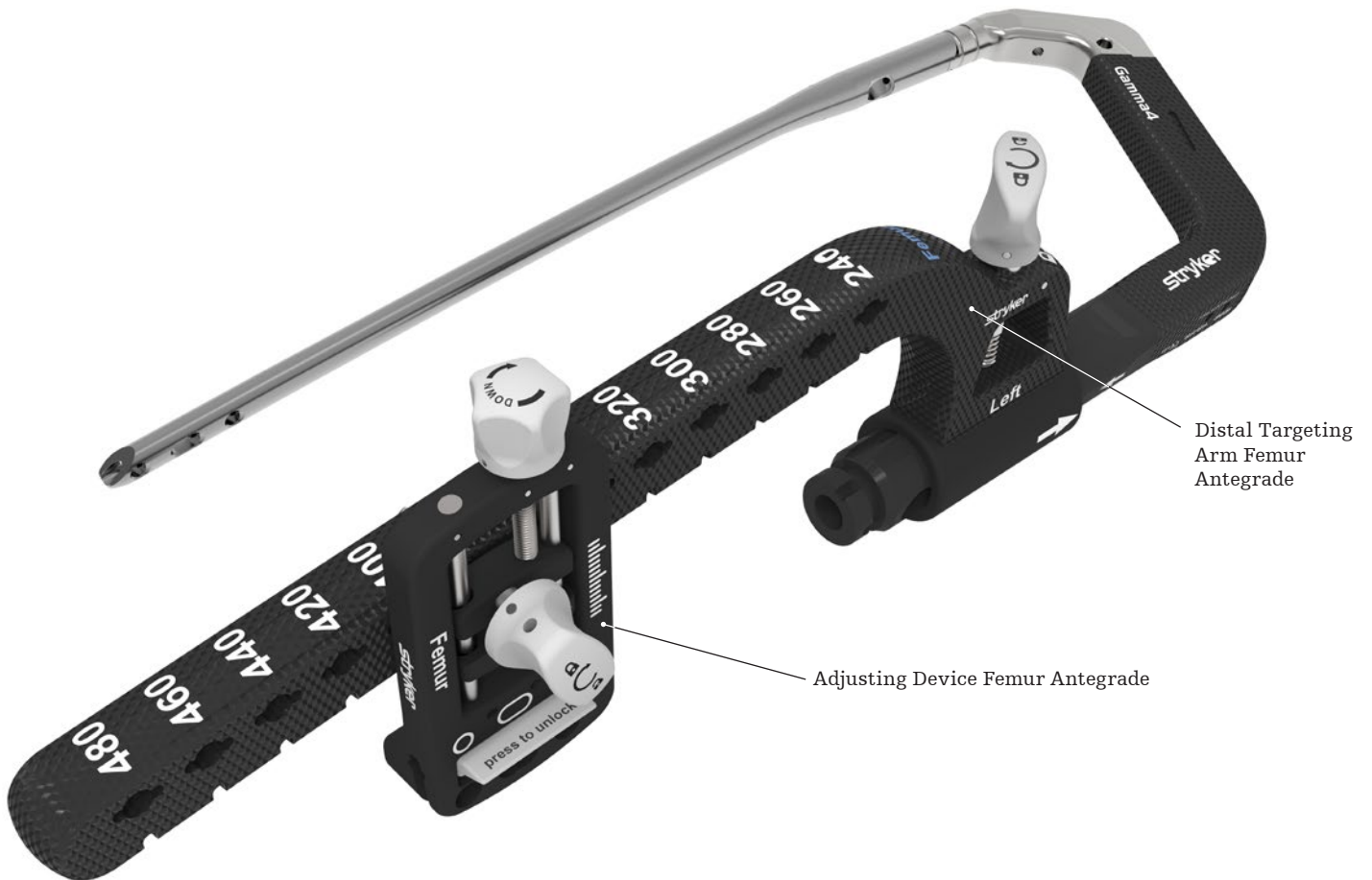

Fig. 124

Operative technique

Assembly

To assemble, first insert the center pin of the Adjusting Device through the hole of the Distal Targeting Arm that corresponds with the selected nail length (Fig. 125). Turn the knob clockwise to lock into position.

Then, slide the opening of the Distal Targeting Arm through the Proximal Targeting Arm (Fig. 126). A click will be felt when the Distal Targeting Arm is correctly positioned. Tighten the fixation knob clockwise to secure (Fig. 127).

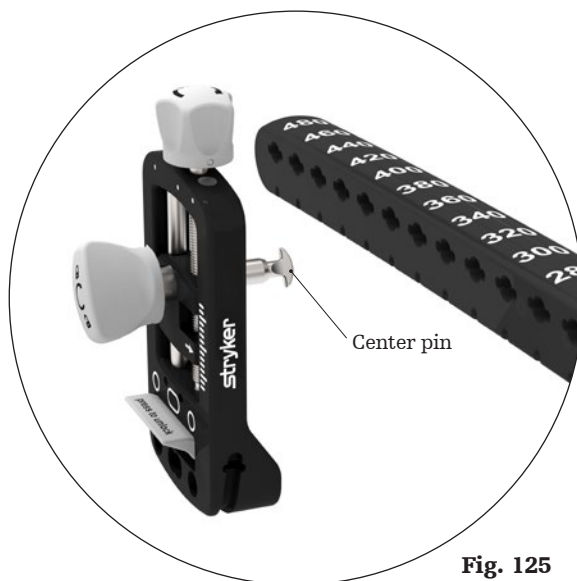

Fig. 125

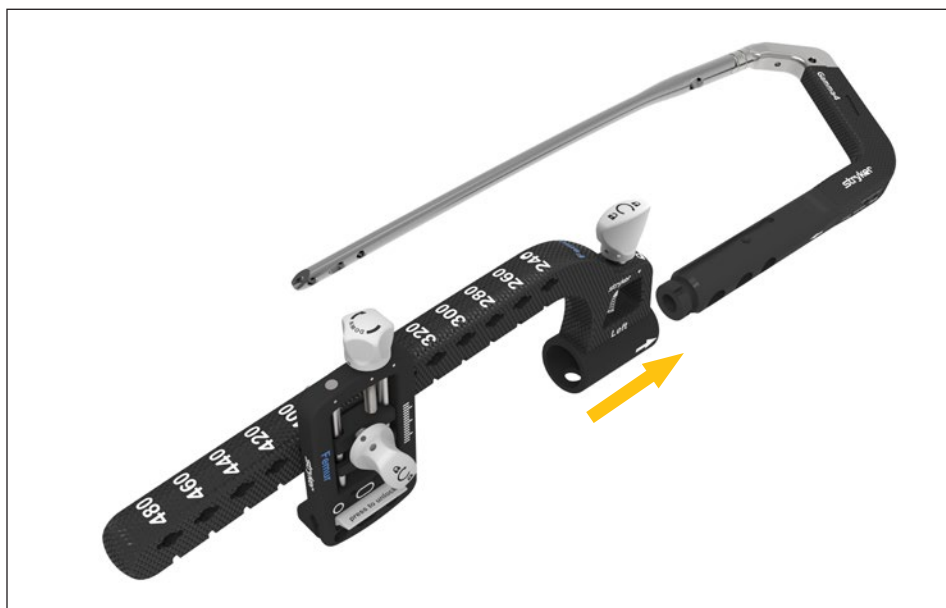

Fig. 126

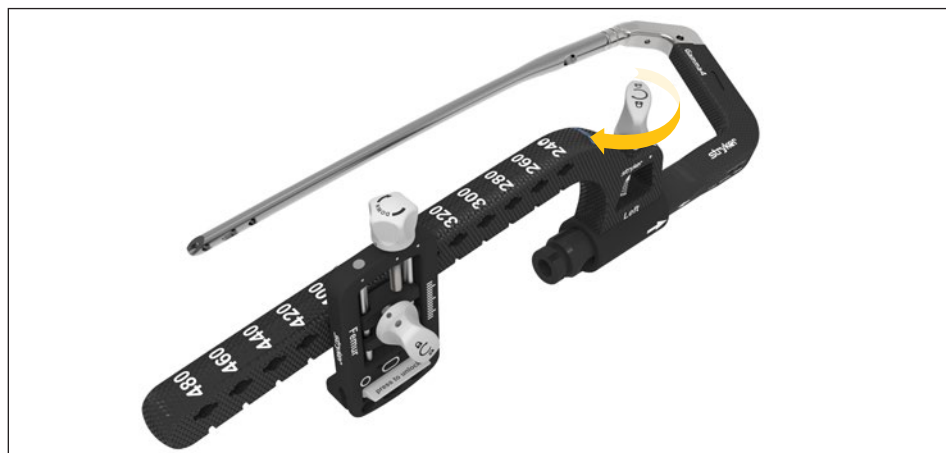

Fig. 127

Operative technique

Pre-operative length verification

To ensure that the Adjusting Device is correctly assembled to the Distal Targeting Arm, pre-operative length verification is recommended prior to nail insertion. On the back table, assemble the Distal Targeting Arm and insert the Tissue Protection Sleeve into a hole of the Adjusting Device and confirm correct alignment with the nail (Fig. 128). If the sleeve is aligned, disassemble the Distal Targeting Arm from the Proximal Targeting Arm and place on the back table or vertically in the dedicated tray position. Do not disassemble the Adjusting Device. If the sleeve is not aligned, rotate the knob (clockwise = down, counter-clockwise = up) until the Tissue Protection Sleeve is aligned with the distal locking hole of the nail.

Proceed with nail and Lag Screw insertion as required, and reassemble the Distal Targeting Arm (incl. Adjusting Device) to the Proximal Targeting Arm prior to distal screw insertion.

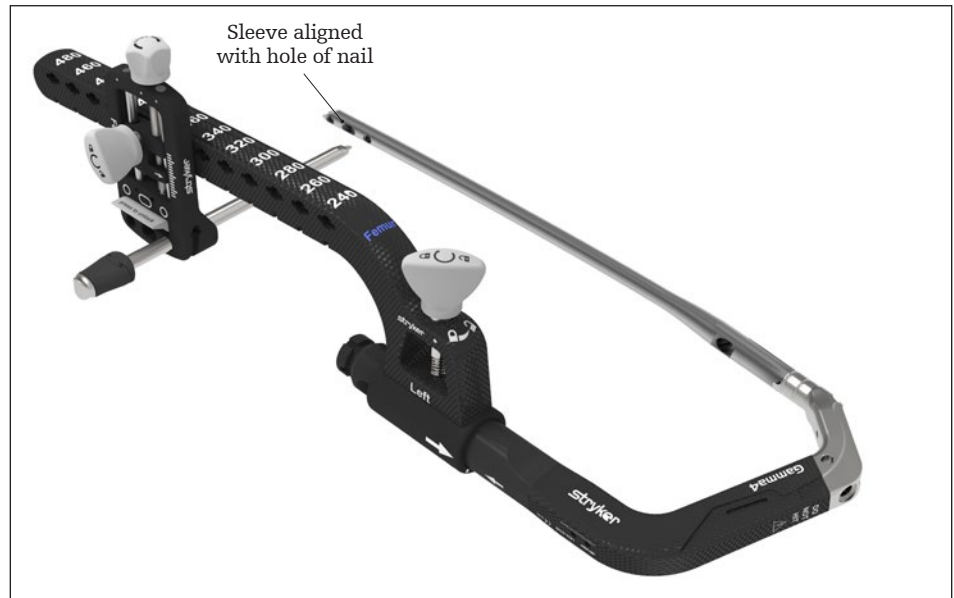

Fig. 128

CAUTION

Prior to nail insertion, it is recommended that pre-calibration is performed in order to check:

- **Adjusting Device is at the correct length**
- **Adjusting Device is securely attached**
- **Distal Targeting Arm is positioned anteriorly to the nail**

Operative technique

Operative assembly

When ready for distal locking, assemble the Distal Targeting System as described in section 'Assembly' above. Once assembled, slide it onto the Proximal Targeting Arm (Fig 129). To secure the system, lock the knob as shown in Fig. 130. Then insert the triple sleeve assembly (Fig. 131).

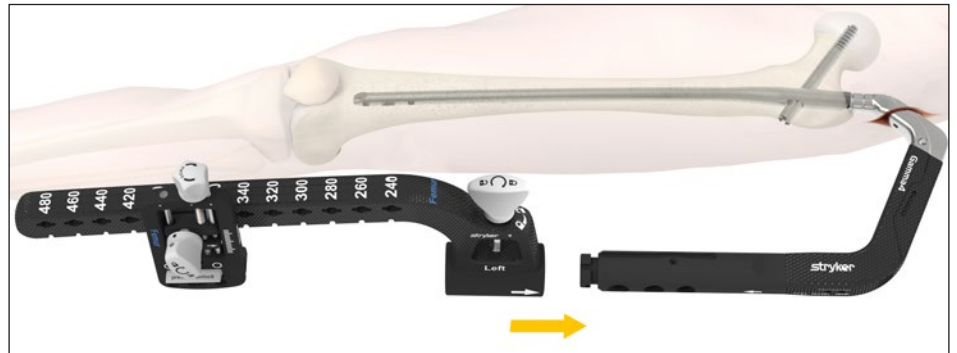

Fig. 129

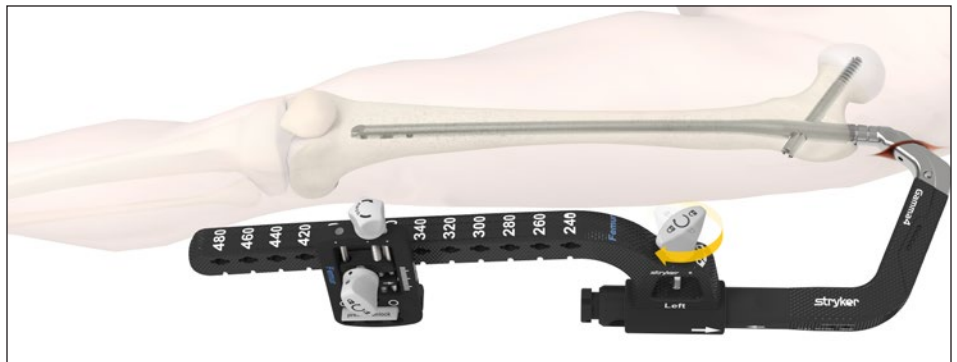

Fig. 130

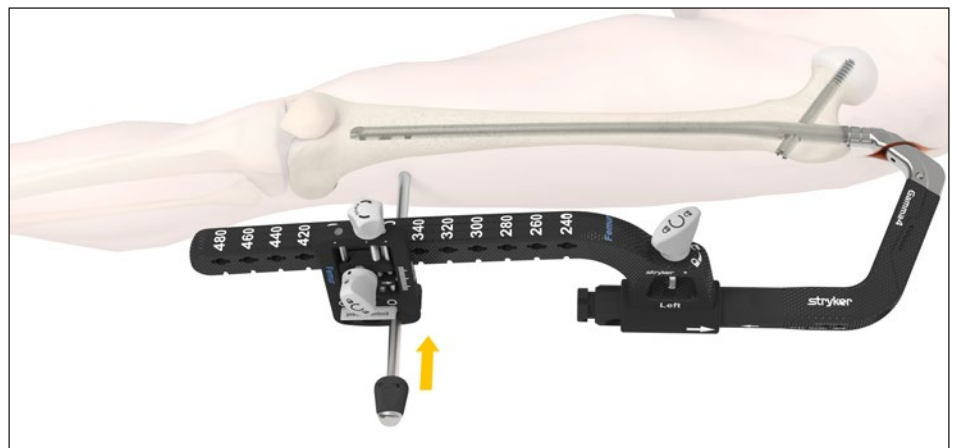

Fig. 131

Operative technique

Oblique C-arm positioning

To perform the guided distal locking, it is essential to align the X-ray beam of a C-arm approximately 30° oblique to the axis of the drill sleeve assembly in the frontal plane (Fig. 132).

As an option, a pin/K-wire (Ø3-3.2mm) can be inserted from the lateral opening of the Adjusting Device (Fig. 133). The X-ray beam should be aligned along the inserted pin, projecting the tip of the sleeve in the center of the image.

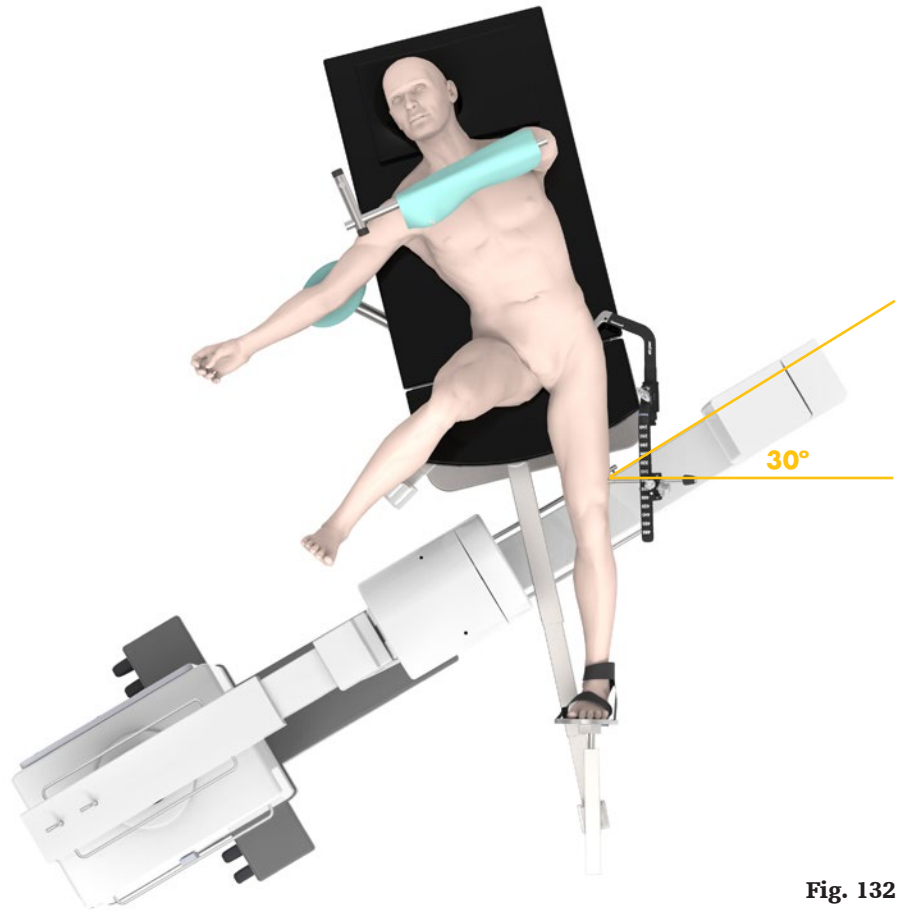

Fig. 132

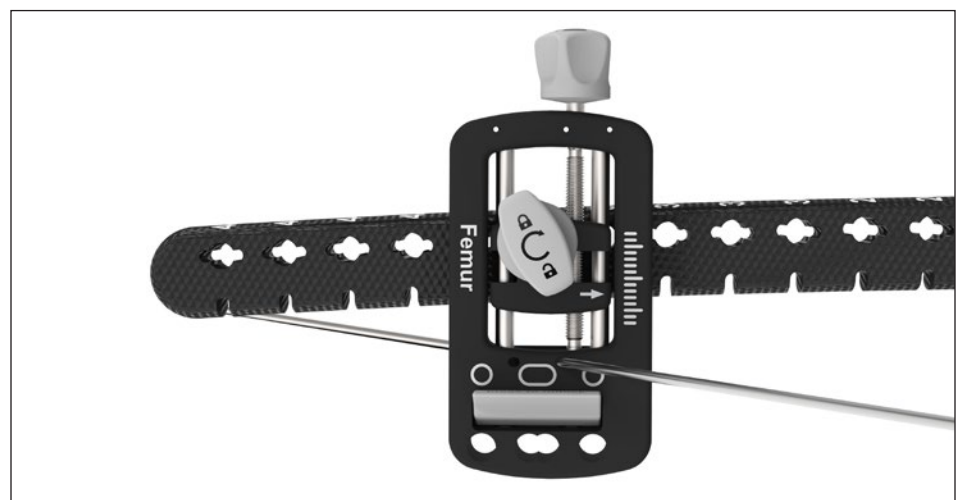

Fig. 133

Operative technique

Height and orbital rotation of the C-arm

After oblique C-arm positioning, adjust the height and orbital rotation of the X-ray beam (Fig. 134) so it is in the same plane as nail tip and sleeve assembly (frontal plane) and take an X-ray.

The goal of the imaging is to show the sleeve and nail tip parallel (Fig. 135). Adjust the C-arm rotation until the correct position is achieved.

If the tip of the sleeve and nail point down (valley), move the X-ray tube up until the nail and sleeve are seen in parallel (Fig. 136, 137).

If the tip of the sleeve and nail point up (peak), move the X-ray tube down until the nail and sleeve are seen in parallel (Fig. 138, 139).

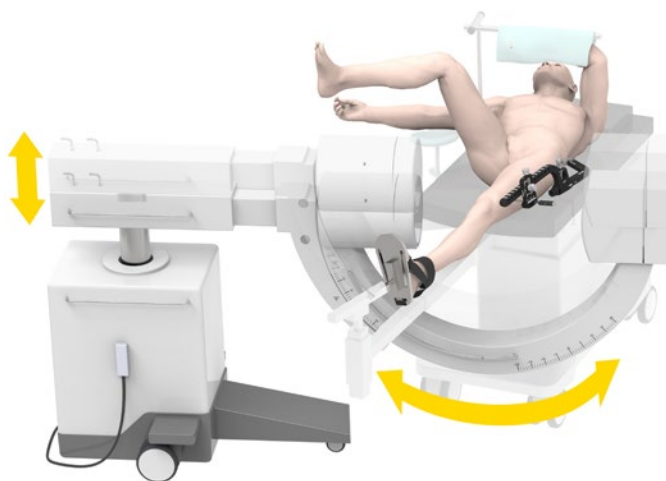

Fig. 134

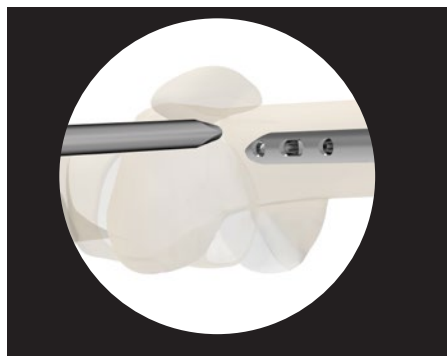

Fig. 135: Sleeve and nail tip are parallel

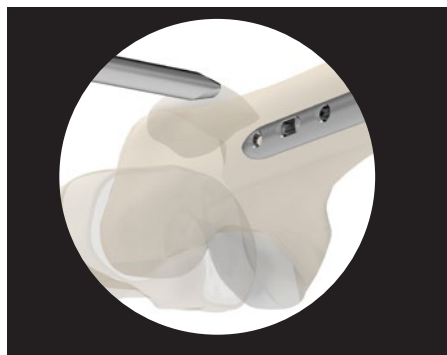

Fig. 136: Sleeve and nail tip form a "valley"



Fig. 138: Sleeve and nail tip form a "peak"

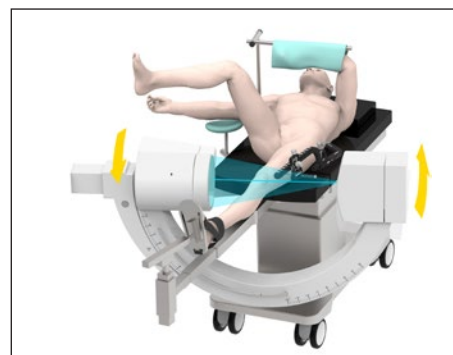

Fig. 137: Rotate C-arm up

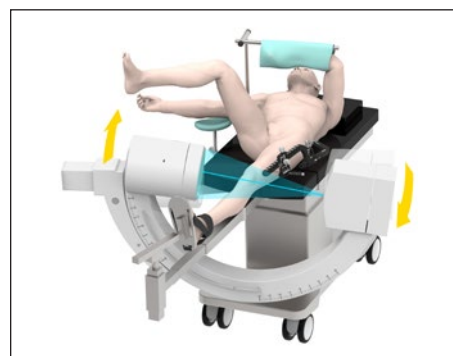

Fig. 139: Rotate C-arm down

Operative technique

Sleeve adjustment

Once the C-arm has been adjusted so that nail and sleeve are shown parallel, the image may show the sleeve either above or below the nail. If the sleeve and the nail are shown collinear, (Fig. 145) no deflection has occurred and no adjustment is needed.

If the sleeve and nail are not seen on the same axis, sleeve adjustment is required by turning the knob of the Adjusting Device (Fig. 140, 142, 144). The sleeve moves anteriorly or posteriorly (Fig. 141, 143):

- Clockwise = posterior direction (down)
- Counter clockwise = anterior direction (up)

Adjust anterior / posterior position until sleeve and nail tip are collinear. The knob on the Adjusting Device indicates the direction to rotate to move the sleeve down (Fig. 142, 144).

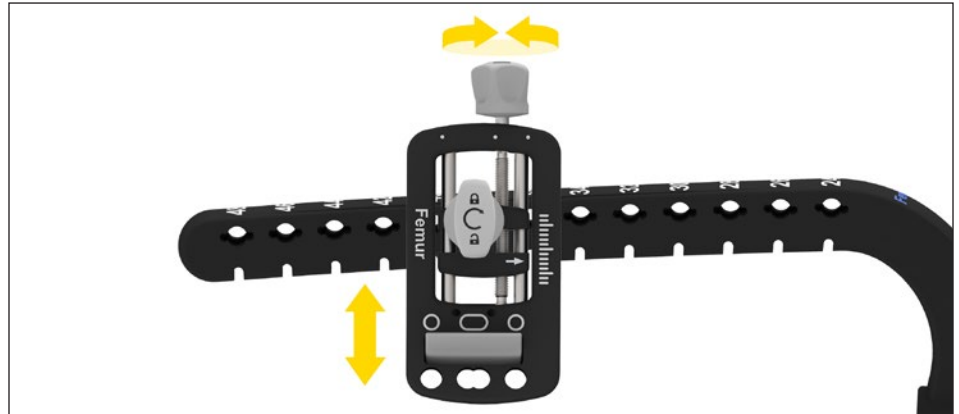

Fig. 140

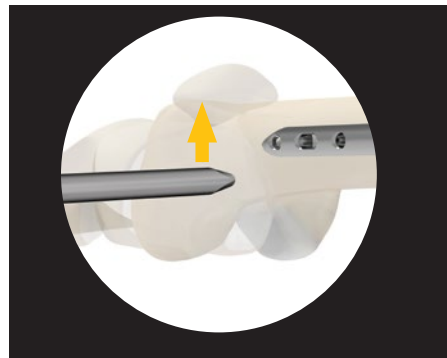

Fig. 141: Turn the Adjusting Device counter-clockwise (up)

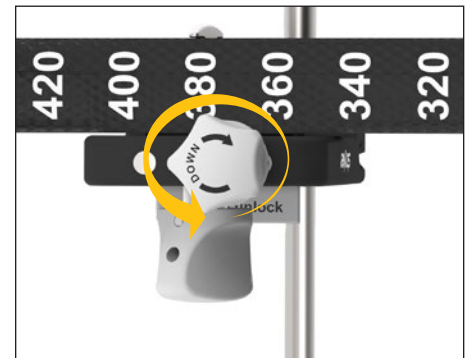

Fig. 142

NOTICE

The sleeve adjustment is performed by turning the knob of the Adjusting Device:

- Clockwise = posterior direction (down)
- Counterclockwise = anterior direction (up)

Patient anatomy, entry point or other factors may result in excessive nail bending that may not be compensated with the Adjusting Device. In these instances, freehand distal locking must be performed.



Fig. 143: Turn the Adjusting Device clockwise (down)



Fig. 144



Fig. 145: Sleeve and nail tip are parallel and collinear. No adjustments needed.

Operative technique

Locking

Once the sleeve has been correctly positioned, push the sleeve assembly to mark the skin (Fig. 146) and then incise the skin at the sleeve entry point. The scalpel can be passed through the Adjusting Device to make the incision (Fig. 147). Ensure that the incision is straight to avoid forces on the sleeve. Advance the sleeve assembly through the incision until contact is made with the lateral cortex.

CAUTION

To avoid misdrilling, ensure that the nail and sleeve are colinear prior to making a skin incision.

For a detailed description of how to make the incision and measure the length of the locking screw and insert the screw, please refer to pages 39-40 section 'Trochanteric Nail distal locking'.

To insert an additional screw(s), use the image intensifier to align the sleeves and repeat the aforementioned steps for sleeve adjustment, drilling and screw insertion.

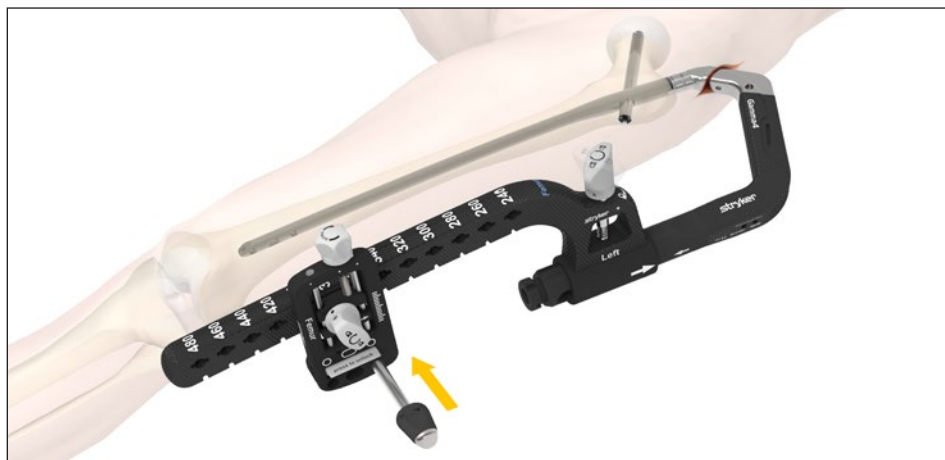

Fig. 146



Fig. 147

Operative technique

Disassembly

Press the sleeve fixation button and remove the screwdrivers and sleeves (Fig. 148). Open the fixation knob of the Distal Targeting Arm. Remove the Distal Targeting Arm from the Proximal Targeting Arm (Fig. 149). Complete the surgery with the End Cap insertion (refer to section 'End Cap insertion').



Fig. 148

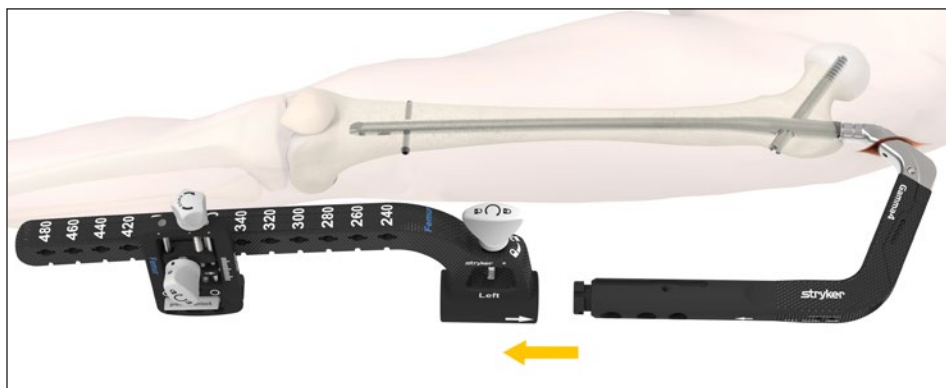

Fig. 149

Operative technique

Freehand distal locking

As an alternative to guided distal locking, the freehand technique may be used to insert the Advanced/Locking Screws.

The critical step with any freehand locking technique is to visualize a perfectly round locking hole or perfectly oblong locking hole with the C-arm (Fig. 150). If the holes appear to be ellipses (Fig. 151), the image intensifier position must be adjusted appropriately. It is recommended to correct the image one plane at a time.

After making an incision, the Freehand Drill is held at an oblique angle to the center of the locking hole (Fig. 152).

Upon X-ray verification, the drill is placed perpendicular to the nail and drilled through the lateral and medial cortex. Confirm in both the anterior and lateral planes by X-ray that the Freehand Drill passes through the hole in the nail. Use the Screw Scale with the Freehand Drill to read off the screw length directly at the color coded marking (Fig. 153a).

Alternatively, the Freehand Depth Gauge may be used after drilling to determine the required screw length (Fig. 153b).

Ref #	Description
2351-4218S	Freehand Drill
2351-0340	Screw Scale
2351-0170	Freehand Depth Gauge, Long
2351-0110	Screwdriver Bit, Long
2351-0111	Self-Retaining Screwdriver Sleeve, Long
2351-0140	Quick-Lock Delta Handle
2351-0390S	Locking Scalpel (optional)

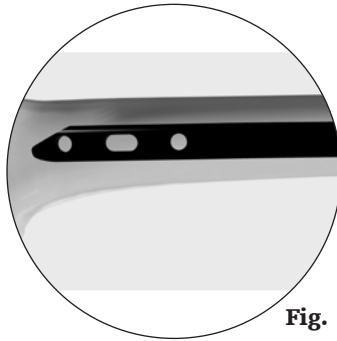

Fig. 150

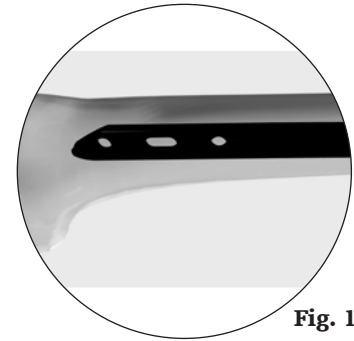

Fig. 151

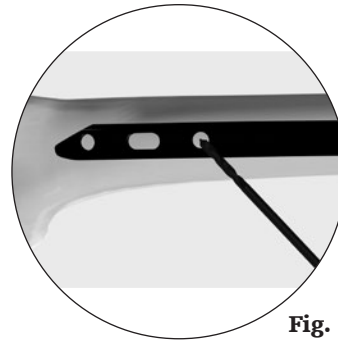

Fig. 152

NOTICE

Take into account the anatomy and X-ray projection which may affect your screw measurement.

CAUTION

Take care to avoid capturing soft tissue during freehand drilling. Advance the skin incision all the way down to the bone.



Fig. 153a



Fig. 153b

Operative technique

The self-retaining screwdriver assembly may be used to facilitate freehand locking. To use, assemble the Self-Retaining Screwdriver Sleeve to the Screwdriver Bit and Quick-Lock Delta Handle. Attach the screw head to the Screwdriver Bit and hand tighten the assembly by turning the Self-Retaining Screwdriver Sleeve counterclockwise (Fig. 154).

The locking screw is inserted with the Screwdriver Bit and Quick-Lock Delta Handle (Fig. 155).

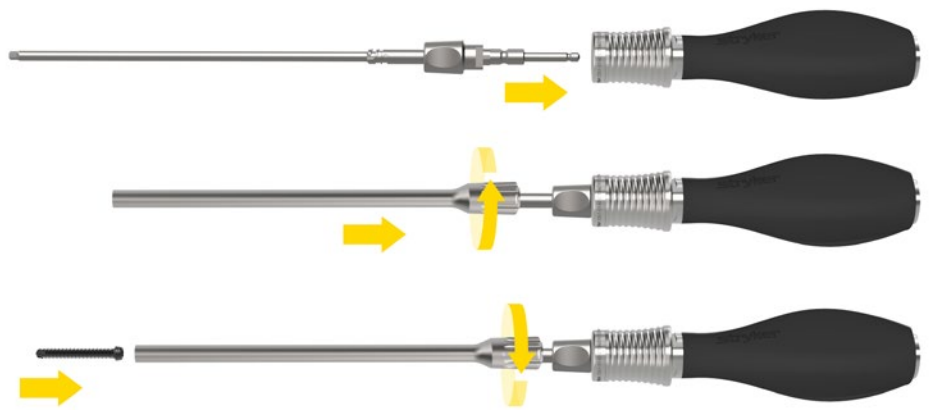

Fig. 154

CAUTION

Take care not to strip the threads in the bone by over tightening.



Fig. 155

Operative technique

Advanced Locking Screws

As an alternative for distal locking in all round holes, the Advanced Locking Screws (Fig. 156) of the IMN Screws System can be used. They are designed to limit the relative axial and angular movement between the nail and screw construct. The screws are designed to increase construct stability within unstable fracture patterns and/or poor bone quality conditions.

The effect of axial stability between nail and Advanced Locking Screws is achieved by a threaded interface. Insertion characteristics of the Advanced Locking Screw might be susceptible to user-related parameters such as drilling angulation or translational offsets during the pre-drilling and insertion processes. Anatomic conditions such as bone quality and cortical bone dimensions might also influence screw insertion.

Elevated insertion torque caused by one or more of the above-mentioned parameters might indicate that axial stable locking is not necessary.

Advanced Locking Screws may be inserted in any 5mm circular hole of the nail (Fig. 157).

Ref #	Description
2351-5500S	Counterbore Drill, Short
2351-5510S	Counterbore Drill, Long
2351-5515S	Counterbore Drill, Manual
2351-0140	Quick-Lock Delta Handle
2351-0110	Screwdriver Bit, Long
2351-0111	Self-Retaining Screwdriver Sleeve, Long (optional)

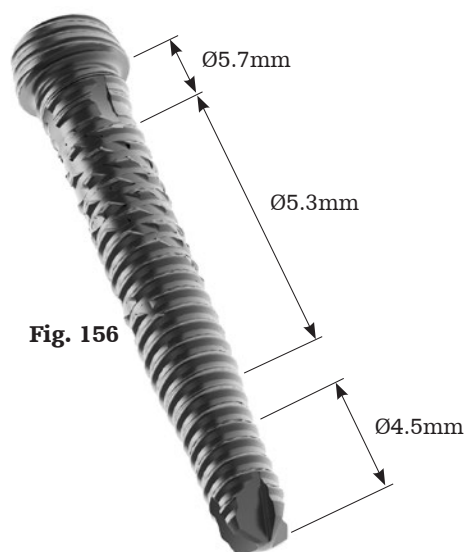

Fig. 156



Fig. 157

⚠ CAUTION

When using the Advanced Locking Screws, take care not to strip the screw threads or head by over tightening. If too much torque is required, use a standard Locking Screw.

⚠ CAUTION

Do not place an Advanced Locking Screw in an oblong hole.

Operative technique

Drill both cortices and determine screw length in a guided or freehand manner as described in sections 'Guided locking' or 'Freehand distal locking' (Fig. 158). Once screw length has been determined, open the near cortex using a Counterbore Drill. Guided locking requires the use of the Counterbore Drill, Long.

Ensure that the drill is centered with the hole of the nail prior to drilling the cortex, and then drill until the stop is felt (Fig. 159). Verify under imaging.

In some instances, thick cortical or cancellous bone may prevent the Counterbore Drill from fully penetrating the near cortex or clearing a passage to the nail. When this occurs, use the Counterbore Drill, Manual, in combination with the Quick-Lock Delta Handle to ensure that the passage to the nail is sufficiently widened. Turn the drill in a gentle clockwise motion with moderate axial pressure until the pathway to the nail has been opened (Fig. 160).



Fig. 158



Fig. 159

⚠ CAUTION
Do not use the Counterbore Drill, Manual with a power tool in order to avoid implant damage.

⚠ CAUTION
Overdrilling with a Counterbore Drill is required prior to Advanced Locking Screw insertion.

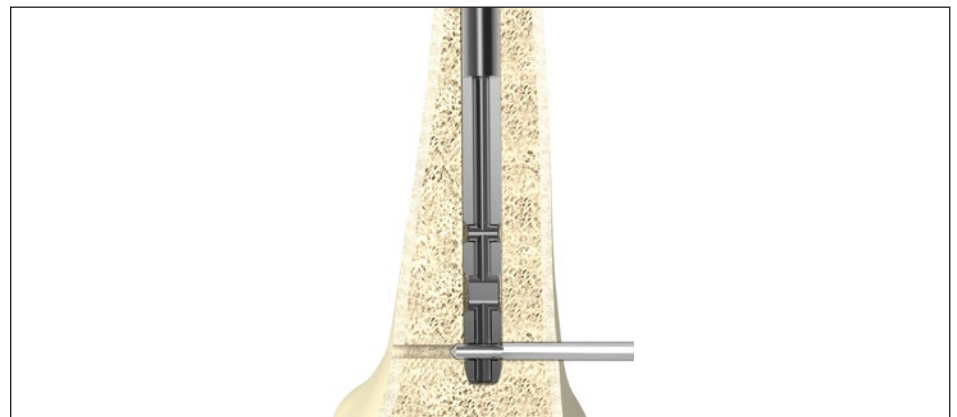

Fig. 160

Operative technique

Once drilling has been completed, insert the Advanced Locking Screw with gentle axial force using the appropriate screwdriver through the near cortex without turning the screw, while ensuring that the axis of the screw is aligned with the corresponding locking hole.

Push the screw until the leading tip is fully engaged with the nail hole.

To confirm correct starting point and axial alignment of the screw, gently rotate the screw counter-clockwise while applying gentle axial force (Fig. 161). A click sound or snapping of the thread indicates that the screw is in the correct position. Once position has been confirmed, insert the screw by rotating clockwise until the screw is fully seated (Fig. 162).

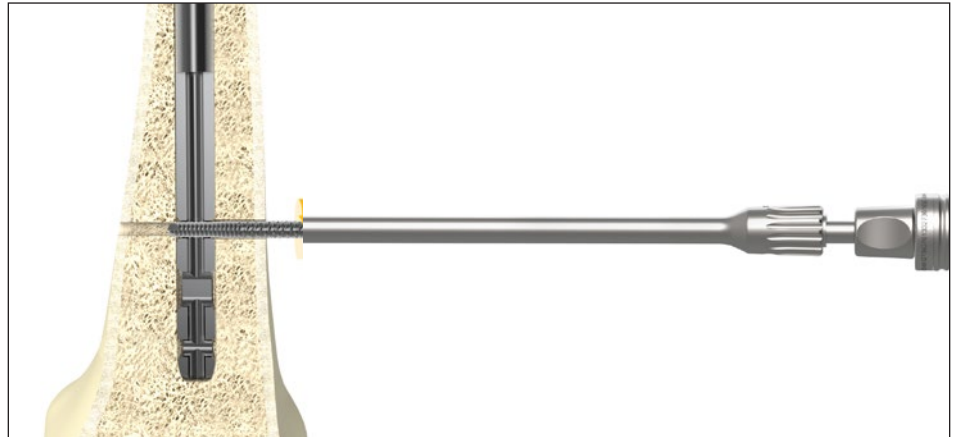

Fig. 161

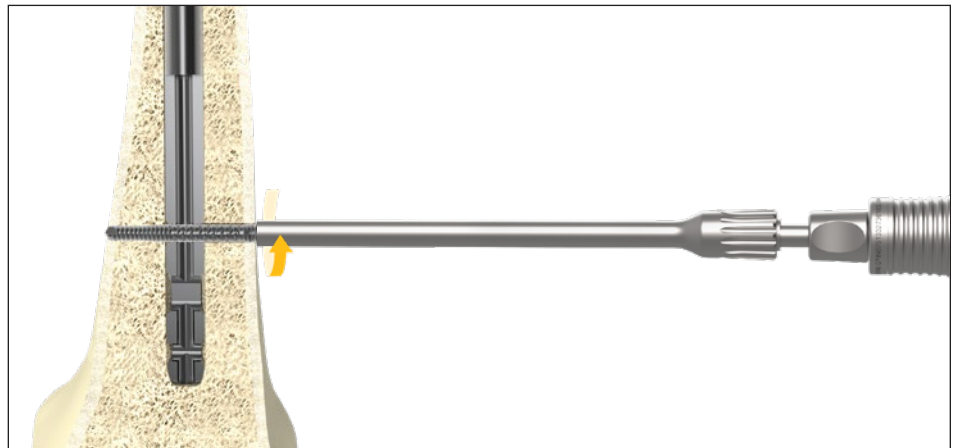

Fig. 162

CAUTION

Carefully observe the nail position during Advanced Locking Screw insertion using X-ray.

Operative technique

End Cap insertion

An End Cap may be used to prevent bony ingrowth.

For End Cap insertion, the Nail Holding Screw has to be removed. In order to keep the Proximal Targeting Arm in place, the screwdriver for distal locking may be kept attached to the distal locking screw (Fig. 163). Load the End Cap (size 0) to the Ball Tip Screwdriver or Set Screw Driver and pass the assembly through the top of the Proximal Targeting Arm down into the nail (Fig. 164). The Set Screw Driver features a conical self-holding mechanism which can be activated by pressing the Set Screw Driver tip into the End Cap.

Turn the handle clockwise until it stops mechanically. Remove the screwdriver, the distal screwdriver and the distal sleeves and remove the Proximal Targeting Arm (Fig. 165).

Alternatively, the End Cap could also be inserted free hand after removal of the Proximal Targeting Arm.

Extension End Caps (size 5, 10 or 15) do not pass through the Proximal Targeting Arm post. Therefore, the Proximal Targeting Arm needs to be removed prior to extension cap insertion.

Ref #	Description
2351-0040	Ball Tip Screwdriver
1420-0270	Set Screw Driver
2351-0140	Quick-Lock Delta Handle

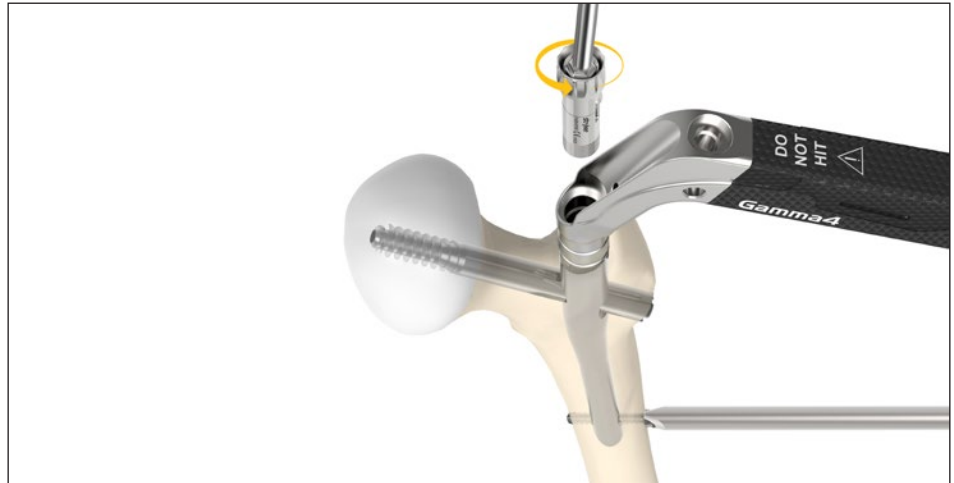

Fig. 163

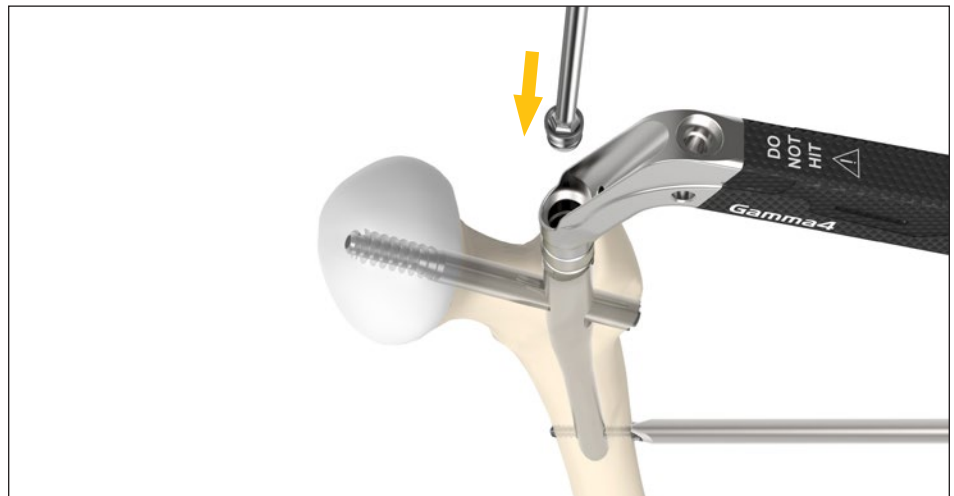

Fig. 164



Fig. 165

Operative technique

Post-operative care and rehabilitation

Active and passive mobilization of the lower limbs may be started immediately. The injured limb should be kept elevated.

For stable fractures with dynamic locking, full weight-bearing walking may be started immediately. For unstable fractures with static locking, immediate full weight-bearing walking is allowed in fractures with good bone contact.

For fractures with poor bone contact due to comminution, partial weightbearing walking is allowed for the first 6 to 8 weeks. Full weight-bearing walking can be commenced when there is a bridging callus formed as evident on the follow up X-ray.

Operative technique

Extraction

For implant extraction, it is strongly recommended to have the Implant Extraction Set available. The Gamma4 implant may be distinguished from the legacy system by the proximal end connection of the nail and the distal chamfer (Fig. 166). To extract the Gamma4 implant, please proceed as follows:

Step 1: Distal screw removal (Fig. 167)

Remove the distal screw(s) using the Ø3.5mm screwdriver after making an incision through the old scar.

Step 2: Lag Screw Driver attachment (Fig. 168, 169)

Make a small incision through the old scar below the greater trochanter to expose the outer end of the Lag Screw. Remove any bony ingrowth which may be obstructing the outer end or internal thread of the Lag Screw as necessary to enable the Lag Screw Driver to engage fully.

The Precision Pin™ is then introduced into the Lag Screw. The Lag Screw Driver is inserted over the Precision Pin™ and engaged with the distal end of the Lag Screw. The Lag Screw Sleeve may help for easier attachment. The Ball Tip Screwdriver should be used to secure the Lag Screw Driver to the Lag Screw.

⚠ CAUTION

Ensure the Lag Screw Driver is fully threaded into the Lag Screw to prevent instrument damage. Bony ingrowth may impede the fixation.

Ref #	Description	Dimensions
1806-6152	Module 1 Instrument Set - Implant Extraction	
1806-6153	Module 2 Instrument Set - Implant Extraction	
2351-0110	Screwdriver Bit, Long	
2351-0140	Quick-Lock Delta Handle	
1420-0260	Lag Screw Driver	
1420-0060S	Precision Pin™	Ø3.9mm × 450mm
1420-0065S	Precision Pin™, tapered	Ø3.2/3.9mm × 450mm
2351-0040	Ball Tip Screwdriver	
1420-0220	Precision Sleeve™	
1420-0300	Extraction Shaft	
2351-0060	Slotted Hammer	
1806-0110	Universal Rod (optional)	
1420-0160	Lag Screw Sleeve (optional)	
2351-0390S	Locking Scalpel (optional)	



Fig. 166



Fig. 167

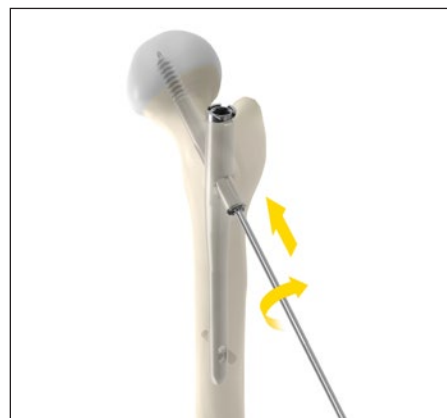

Fig. 168



Fig. 169

Operative technique

Step 3: End Cap removal and set screw release (Fig. 170, 171)

An incision is made over the proximal end of the nail and the proximal End Cap (if used) is removed using a Ø4mm Hex connection. It is recommended to use the connection from the Implant Extraction Set. Removal may be difficult due to bony ingrowth and patient anatomy. If not available, use the Ball Tip Screwdriver or the Set Screw Driver. Use the Set Screw Driver to engage the set screw. The set screw is rotated counter-clockwise until the Lag Screw can be removed. For all nail types, the Lag Screw is released after 3 full turns of the set screw.

⚠ CAUTION

If the set screw cannot be released during extraction, slight hammer taps on the Set Screw Driver and/or Lag Screw Driver (lateral direction) may facilitate the set screw release.

⚠ CAUTION

When the Lag Screw is released, do not unscrew the set screw further in order to allow for full Extraction Shaft engagement.

Step 4: Lag Screw extraction (Fig. 172, 173)

The Extraction Shaft is then threaded and tightened into the proximal end of the nail. The Lag Screw is extracted by counter-clockwise rotation and pulling of the Lag Screw Driver. The Precision Pin™ is then removed.

Step 5: Nail extraction (Fig. 174)

An appropriate sliding hammer assembly (e.g. Universal Rod in combination with Slotted Hammer) is attached to the Extraction Shaft and the nail is extracted.



Fig. 170



Fig. 171

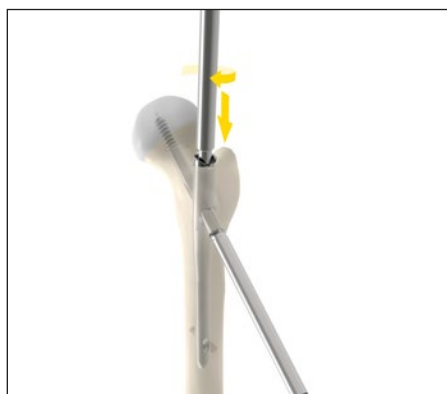

Fig. 172

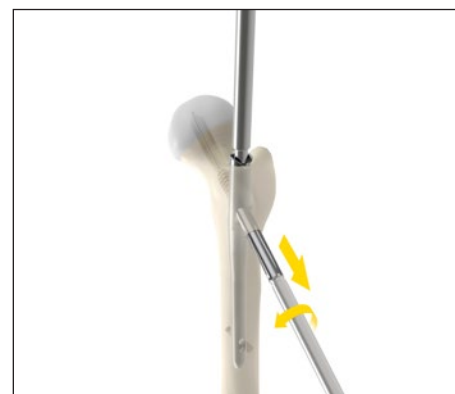

Fig. 173



Fig. 174

⚠ WARNING

Take care during extraction to avoid severe bone and/or soft tissue damage. Ensure that all implants are removed using the appropriate extraction instruments. Stryker offers a universal Implant Extraction Set that shall be used with the Gamma4 Extraction Shaft.

Operative technique

RC Lag Screw Extraction

Follow steps 1 to 3 above. Remove the U-blade end cap of the RC Lag Screw by using the Set Screw Driver.

Step 4a: U-blade extraction (Fig 175)

Mount the RC Inserter over the K-wire / Precision Pin™ to the U-blade by turning it clockwise by hand. Check that no ingrowth or soft tissue is between the connecting parts. If the thread of the RC Inserter is engaged with the U-blade, retract the RC Inserter. If the U-blade is not loosened at this stage, a rod can be inserted through the holes of the RC Inserter assembly to provide a strong handle for pulling it back.

Step 4b: RC Lag Screw extraction (Fig 176)

The Lag Screw Driver is passed over the K-wire/Precision Pin™ and engaged with the distal end of the RC Lag Screw. Make sure that the pegs of the Lag Screw Driver fit to the RC Lag Screw. Tighten the thumbwheel clockwise. Follow steps 4 and 5 of 'Extraction'.



Fig. 175

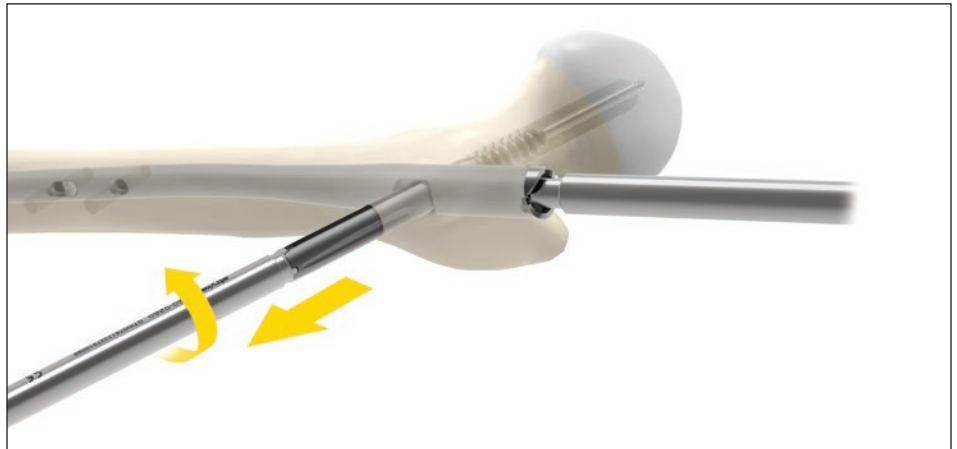

Fig. 176

Operative technique

Optional bone void filler

A bone void filler, such as SimpliFill, can be injected into surgically created osseous defects or osseous defects created from traumatic injury to the bone.

For the application of bone void filler:

1. Place the Lag Screw 30mm short from the final position (for length reference: the thread of the Lag Screw is 30mm long) (Fig. 177). For depth indication the depth indicator rings on the Lag Screw Driver can be used (three rings away from solid line for Lag Screw and from dotted line for RC Lag Screw).
2. Disassemble the Lag Screw Driver from the Lag Screw.
3. Withdraw the Precision Pin™ until its tip is flush with the Lag Screw tip (Fig. 178).
4. Place the cannula next to the protruding part of the Precision Pin™ and cut off the corresponding length of the cannula tip at a 45° angle (Fig. 179).
5. Fully remove the Precision Pin™.
6. Prepare the bone void filler (for details, refer to the instructions provided with the product).
7. Attach the bone void filler syringe to the precut cannula.
8. Fill the cannula with the bone void filler to remove any trapped air.
9. Insert the cannula until the wings of the cannula dead stop inside the Lag Screw Sleeve (Fig. 180a, Fig. 180b).
10. Inject the bone void filler under X-ray control until the bone cavity in front of the Lag Screw tip is filled.
11. Remove the cannula and syringe.
12. Re-insert the Precision Pin™ to desired position in order to prevent backflow of the bone void filler into the cannulation of the Lag Screw during Lag Screw insertion.
13. Re-assemble the Lag Screw Driver to the Lag Screw.
14. Insert the Lag Screw to its final position. For proper Lag Screw positioning, refer to section 'Lag Screw insertion'.

Ref #	Description
1420LVGA	SimpliFill



Fig. 177



Fig. 178



Fig. 179

Operative technique



Fig. 180a



Fig. 180b

⚠ CAUTION

Avoid leakage of bone void filler into the:

- Soft tissue (the hardened material may cause soft tissue irritation)
- Cannulation of the implants and instruments and their interfaces (the functionality of the devices may be compromised)

⚠ CAUTION

Ensure that the procedure is completed within the working time limit of the bone void filler. In case of unreasonably high Lag Screw insertion torque (e.g. injected bone void filler already hardened), remove the Lag Screw and re-ream the Lag Screw path.

⚠ WARNING

If the femoral head has been perforated, a bone void filler must not be used. Take special care during Precision Pin™ placement.

⚠ WARNING

Monitor the applied volume using the syringe scale and observe the material flow under X-ray when injecting. The reamed cavity to be filled is approximately 1 cc. Cease application if excessive injection pressure is required to inject or if unintended material flow occurs.

Refer to associated package insert of the bone void filler manufacturer for specific warnings, precautions and use.

Gamma4™

Hip Fracture Nailing System



System components

System components



Trochanteric Nail, 170mm

Ref #	Diameter (mm)	GCD Angle (°)
8120-9170S	Ø9	120
8120-0170S	Ø10	120
8120-1170S	Ø11	120
8120-2170S	Ø12	120
8120-3170S	Ø13	120
8125-9170S	Ø9	125
8125-0170S	Ø10	125
8125-1170S	Ø11	125
8125-2170S	Ø12	125
8125-3170S	Ø13	125
8130-9170S	Ø9	130
8130-0170S	Ø10	130
8130-1170S	Ø11	130
8130-2170S	Ø12	130
8130-3170S	Ø13	130

System components



Intermediate Nail

Left Ref #	Right Ref #	Length (mm)	GCD Angle (°)
8320-9240S	8220-9240S	Ø9	120
8320-0240S	8220-0240S	Ø10	120
8320-1240S	8220-1240S	Ø11	120
8320-2240S	8220-2240S	Ø12	120
8320-3240S	8220-3240S	Ø13	120
8325-9240S	8225-9240S	Ø9	125
8325-0240S	8225-0240S	Ø10	125
8325-1240S	8225-1240S	Ø11	125
8325-2240S	8225-2240S	Ø12	125
8325-3240S	8225-3240S	Ø13	125
8330-9240S	8230-9240S	Ø9	130
8330-0240S	8230-0240S	Ø10	130
8330-1240S	8230-1240S	Ø11	130
8330-2240S	8230-2240S	Ø12	130
8330-3240S	8230-3240S	Ø13	130

System components

**Long Nail, Ø9mm**

Left Ref #	Right Ref #	Length (mm)	CCD Angle (°)
8520-9240S	8420-9240S	240	120
8520-9260S	8420-9260S	260	120
8520-9280S	8420-9280S	280	120
8520-9300S	8420-9300S	300	120
8520-9320S	8420-9320S	320	120
8520-9340S	8420-9340S	340	120
8520-9360S	8420-9360S	360	120
8520-9380S	8420-9380S	380	120
8520-9400S	8420-9400S	400	120
8520-9420S	8420-9420S	420	120
8520-9440S	8420-9440S	440	120
8520-9460S	8420-9460S	460	120
8520-9480S	8420-9480S	480	120
8525-9240S	8425-9240S	240	125
8525-9260S	8425-9260S	260	125
8525-9280S	8425-9280S	280	125
8525-9300S	8425-9300S	300	125
8525-9320S	8425-9320S	320	125
8525-9340S	8425-9340S	340	125
8525-9360S	8425-9360S	360	125
8525-9380S	8425-9380S	380	125
8525-9400S	8425-9400S	400	125
8525-9420S	8425-9420S	420	125
8525-9440S	8425-9440S	440	125
8525-9460S	8425-9460S	460	125
8525-9480S	8425-9480S	480	125
8530-9240S	8430-9240S	240	130
8530-9260S	8430-9260S	260	130
8530-9280S	8430-9280S	280	130
8530-9300S	8430-9300S	300	130
8530-9320S	8430-9320S	320	130
8530-9340S	8430-9340S	340	130
8530-9360S	8430-9360S	360	130
8530-9380S	8430-9380S	380	130
8530-9400S	8430-9400S	400	130
8530-9420S	8430-9420S	420	130
8530-9440S	8430-9440S	440	130
8530-9460S	8430-9460S	460	130
8530-9480S	8430-9480S	480	130

System components



Long Nail, Ø10mm

Left Ref #	Right Ref #	Length (mm)	GCD Angle (°)
8520-0240S	8420-0240S	240	120
8520-0260S	8420-0260S	260	120
8520-0280S	8420-0280S	280	120
8520-0300S	8420-0300S	300	120
8520-0320S	8420-0320S	320	120
8520-0340S	8420-0340S	340	120
8520-0360S	8420-0360S	360	120
8520-0380S	8420-0380S	380	120
8520-0400S	8420-0400S	400	120
8520-0420S	8420-0420S	420	120
8520-0440S	8420-0440S	440	120
8520-0460S	8420-0460S	460	120
8520-0480S	8420-0480S	480	120
8525-0240S	8425-0240S	240	125
8525-0260S	8425-0260S	260	125
8525-0280S	8425-0280S	280	125
8525-0300S	8425-0300S	300	125
8525-0320S	8425-0320S	320	125
8525-0340S	8425-0340S	340	125
8525-0360S	8425-0360S	360	125
8525-0380S	8425-0380S	380	125
8525-0400S	8425-0400S	400	125
8525-0420S	8425-0420S	420	125
8525-0440S	8425-0440S	440	125
8525-0460S	8425-0460S	460	125
8525-0480S	8425-0480S	480	125
8530-0240S	8430-0240S	240	130
8530-0260S	8430-0260S	260	130
8530-0280S	8430-0280S	280	130
8530-0300S	8430-0300S	300	130
8530-0320S	8430-0320S	320	130
8530-0340S	8430-0340S	340	130
8530-0360S	8430-0360S	360	130
8530-0380S	8430-0380S	380	130
8530-0400S	8430-0400S	400	130
8530-0420S	8430-0420S	420	130
8530-0440S	8430-0440S	440	130
8530-0460S	8430-0460S	460	130
8530-0480S	8430-0480S	480	130

System components

**Long Nail, Ø11mm**

Left Ref #	Right Ref #	Length (mm)	CCD Angle (°)
8520-1240S	8420-1240S	240	120
8520-1260S	8420-1260S	260	120
8520-1280S	8420-1280S	280	120
8520-1300S	8420-1300S	300	120
8520-1320S	8420-1320S	320	120
8520-1340S	8420-1340S	340	120
8520-1360S	8420-1360S	360	120
8520-1380S	8420-1380S	380	120
8520-1400S	8420-1400S	400	120
8520-1420S	8420-1420S	420	120
8520-1440S	8420-1440S	440	120
8520-1460S	8420-1460S	460	120
8520-1480S	8420-1480S	480	120
8525-1240S	8425-1240S	240	125
8525-1260S	8425-1260S	260	125
8525-1280S	8425-1280S	280	125
8525-1300S	8425-1300S	300	125
8525-1320S	8425-1320S	320	125
8525-1340S	8425-1340S	340	125
8525-1360S	8425-1360S	360	125
8525-1380S	8425-1380S	380	125
8525-1400S	8425-1400S	400	125
8525-1420S	8425-1420S	420	125
8525-1440S	8425-1440S	440	125
8525-1460S	8425-1460S	460	125
8525-1480S	8425-1480S	480	125
8530-1240S	8430-1240S	240	130
8530-1260S	8430-1260S	260	130
8530-1280S	8430-1280S	280	130
8530-1300S	8430-1300S	300	130
8530-1320S	8430-1320S	320	130
8530-1340S	8430-1340S	340	130
8530-1360S	8430-1360S	360	130
8530-1380S	8430-1380S	380	130
8530-1400S	8430-1400S	400	130
8530-1420S	8430-1420S	420	130
8530-1440S	8430-1440S	440	130
8530-1460S	8430-1460S	460	130
8530-1480S	8430-1480S	480	130

System components



Long Nail, Ø12mm

Left Ref #	Right Ref #	Length (mm)	GCD Angle (°)
8520-2240S	8420-2240S	240	120
8520-2260S	8420-2260S	260	120
8520-2280S	8420-2280S	280	120
8520-2300S	8420-2300S	300	120
8520-2320S	8420-2320S	320	120
8520-2340S	8420-2340S	340	120
8520-2360S	8420-2360S	360	120
8520-2380S	8420-2380S	380	120
8520-2400S	8420-2400S	400	120
8520-2420S	8420-2420S	420	120
8520-2440S	8420-2440S	440	120
8520-2460S	8420-2460S	460	120
8520-2480S	8420-2480S	480	120
8525-2240S	8425-2240S	240	125
8525-2260S	8425-2260S	260	125
8525-2280S	8425-2280S	280	125
8525-2300S	8425-2300S	300	125
8525-2320S	8425-2320S	320	125
8525-2340S	8425-2340S	340	125
8525-2360S	8425-2360S	360	125
8525-2380S	8425-2380S	380	125
8525-2400S	8425-2400S	400	125
8525-2420S	8425-2420S	420	125
8525-2440S	8425-2440S	440	125
8525-2460S	8425-2460S	460	125
8525-2480S	8425-2480S	480	125
8530-2240S	8430-2240S	240	130
8530-2260S	8430-2260S	260	130
8530-2280S	8430-2280S	280	130
8530-2300S	8430-2300S	300	130
8530-2320S	8430-2320S	320	130
8530-2340S	8430-2340S	340	130
8530-2360S	8430-2360S	360	130
8530-2380S	8430-2380S	380	130
8530-2400S	8430-2400S	400	130
8530-2420S	8430-2420S	420	130
8530-2440S	8430-2440S	440	130
8530-2460S	8430-2460S	460	130
8530-2480S	8430-2480S	480	130

System components

**Long Nail, Ø13mm**

Left Ref #	Right Ref #	Length (mm)	CCD Angle (°)
8520-3240S	8420-3240S	240	120
8520-3260S	8420-3260S	260	120
8520-3280S	8420-3280S	280	120
8520-3300S	8420-3300S	300	120
8520-3320S	8420-3320S	320	120
8520-3340S	8420-3340S	340	120
8520-3360S	8420-3360S	360	120
8520-3380S	8420-3380S	380	120
8520-3400S	8420-3400S	400	120
8520-3420S	8420-3420S	420	120
8520-3440S	8420-3440S	440	120
8520-3460S	8420-3460S	460	120
8520-3480S	8420-3480S	480	120
8525-3240S	8425-3240S	240	125
8525-3260S	8425-3260S	260	125
8525-3280S	8425-3280S	280	125
8525-3300S	8425-3300S	300	125
8525-3320S	8425-3320S	320	125
8525-3340S	8425-3340S	340	125
8525-3360S	8425-3360S	360	125
8525-3380S	8425-3380S	380	125
8525-3400S	8425-3400S	400	125
8525-3420S	8425-3420S	420	125
8525-3440S	8425-3440S	440	125
8525-3460S	8425-3460S	460	125
8525-3480S	8425-3480S	480	125
8530-3240S	8430-3240S	240	130
8530-3260S	8430-3260S	260	130
8530-3280S	8430-3280S	280	130
8530-3300S	8430-3300S	300	130
8530-3320S	8430-3320S	320	130
8530-3340S	8430-3340S	340	130
8530-3360S	8430-3360S	360	130
8530-3380S	8430-3380S	380	130
8530-3400S	8430-3400S	400	130
8530-3420S	8430-3420S	420	130
8530-3440S	8430-3440S	440	130
8530-3460S	8430-3460S	460	130
8530-3480S	8430-3480S	480	130

System components



Long Nail, Ø15mm

Left Ref #	Right Ref #	Length (mm)	GCD Angle (°)
8520-5240S	8420-5240S	240	120
8520-5260S	8420-5260S	260	120
8520-5280S	8420-5280S	280	120
8520-5300S	8420-5300S	300	120
8520-5320S	8420-5320S	320	120
8520-5340S	8420-5340S	340	120
8520-5360S	8420-5360S	360	120
8520-5380S	8420-5380S	380	120
8520-5400S	8420-5400S	400	120
8520-5420S	8420-5420S	420	120
8520-5440S	8420-5440S	440	120
8520-5460S	8420-5460S	460	120
8520-5480S	8420-5480S	480	120
8525-5240S	8425-5240S	240	125
8525-5260S	8425-5260S	260	125
8525-5280S	8425-5280S	280	125
8525-5300S	8425-5300S	300	125
8525-5320S	8425-5320S	320	125
8525-5340S	8425-5340S	340	125
8525-5360S	8425-5360S	360	125
8525-5380S	8425-5380S	380	125
8525-5400S	8425-5400S	400	125
8525-5420S	8425-5420S	420	125
8525-5440S	8425-5440S	440	125
8525-5460S	8425-5460S	460	125
8525-5480S	8425-5480S	480	125
8530-5240S	8430-5240S	240	130
8530-5260S	8430-5260S	260	130
8530-5280S	8430-5280S	280	130
8530-5300S	8430-5300S	300	130
8530-5320S	8430-5320S	320	130
8530-5340S	8430-5340S	340	130
8530-5360S	8430-5360S	360	130
8530-5380S	8430-5380S	380	130
8530-5400S	8430-5400S	400	130
8530-5420S	8430-5420S	420	130
8530-5440S	8430-5440S	440	130
8530-5460S	8430-5460S	460	130
8530-5480S	8430-5480S	480	130

System components

**Lag Screw**

Ref #	Diameter (mm)	Length (mm)
8160-0070S	Ø10.5	70
8160-0075S	Ø10.5	75
8160-0080S	Ø10.5	80
8160-0085S	Ø10.5	85
8160-0090S	Ø10.5	90
8160-0095S	Ø10.5	95
8160-0100S	Ø10.5	100
8160-0105S	Ø10.5	105
8160-0110S	Ø10.5	110
8160-0115S	Ø10.5	115
8160-0120S	Ø10.5	120
8160-0125S	Ø10.5	125
8160-0130S	Ø10.5	130

**RC Lag Screw**

Ref #	Diameter (mm)	Length (mm)
8166-0070S	Ø10.5	70
8166-0075S	Ø10.5	75
8166-0080S	Ø10.5	80
8166-0085S	Ø10.5	85
8166-0090S	Ø10.5	90
8166-0095S	Ø10.5	95
8166-0100S	Ø10.5	100
8166-0105S	Ø10.5	105
8166-0110S	Ø10.5	110
8166-0115S	Ø10.5	115
8166-0120S	Ø10.5	120
8166-0125S	Ø10.5	125
8166-0130S	Ø10.5	130



Locking Screw

Ref #	Diameter (mm)	Length (mm)
2360-5025S	Ø5.0	25.0
2360-5027S	Ø5.0	27.5
2360-5030S	Ø5.0	30.0
2360-5032S	Ø5.0	32.5
2360-5035S	Ø5.0	35.0
2360-5037S	Ø5.0	37.5
2360-5040S	Ø5.0	40.0
2360-5042S	Ø5.0	42.5
2360-5045S	Ø5.0	45.0
2360-5047S	Ø5.0	47.5
2360-5050S	Ø5.0	50.0
2360-5052S	Ø5.0	52.5
2360-5055S	Ø5.0	55.0
2360-5057S	Ø5.0	57.5
2360-5060S	Ø5.0	60.0
2360-5065S	Ø5.0	65.0
2360-5070S	Ø5.0	70.0
2360-5075S	Ø5.0	75.0
2360-5080S	Ø5.0	80.0
2360-5085S	Ø5.0	85.0
2360-5090S	Ø5.0	90.0
2360-5095S	Ø5.0	95.0
2360-5100S	Ø5.0	100.0
2360-5105S	Ø5.0	105.0
2360-5110S	Ø5.0	110.0
2360-5115S	Ø5.0	115.0
2360-5120S	Ø5.0	120.0

System components

**Advanced Locking Screw**

Ref #	Diameter (mm)	Length (mm)
2361-5030S	Ø5.0	30.0
2361-5032S	Ø5.0	32.5
2361-5035S	Ø5.0	35.0
2361-5037S	Ø5.0	37.5
2361-5040S	Ø5.0	40.0
2361-5042S	Ø5.0	42.5
2361-5045S	Ø5.0	45.0
2361-5047S	Ø5.0	47.5
2361-5050S	Ø5.0	50.0
2361-5052S	Ø5.0	52.5
2361-5055S	Ø5.0	55.0
2361-5057S	Ø5.0	57.5
2361-5060S	Ø5.0	60.0
2361-5065S	Ø5.0	65.0
2361-5070S	Ø5.0	70.0
2361-5075S	Ø5.0	75.0
2361-5080S	Ø5.0	80.0
2361-5085S	Ø5.0	85.0
2361-5090S	Ø5.0	90.0
2361-5095S	Ø5.0	95.0
2361-5100S	Ø5.0	100.0

**End Cap**

Ref #	Diameter (mm)	Length (mm)
8004-0000S	Ø11	0
8004-0005S	Ø15.5	5
8004-0010S	Ø15.5	10
8004-0015S	Ø15.5	15

System components

Indication specific instruments

	Ref #	Description
	1420-0000	Indication Kit
	1420-0050	Opening Sleeve
	1420-0055	Opening Guide
	1420-0080	Opening Reamer
	1420-0100	Proximal Targeting Arm
	1420-0105	Nail Holding Screw
	1420-0110	Targeting Sleeve
	1420-0112	Targeting Sleeve Knob (spare part)
	1420-0190	Anti-Rotation Clip
	1420-0192	Anti-Rotation Sleeve
	1420-2100	Intermediate Targeting Sleeve
	1420-3010	RC Guide
	1420-3020	RC Inserter
	1420-0160	Lag Screw Sleeve
	1420-0220	Precision Sleeve™
	1420-0240	Lag Screw Reamer
	1420-0260	Lag Screw Driver
	1420-0270	Set Screw Driver
	1420-0300	Extraction Shaft
	2351-6000*	Opening Reamer Handle
	1420-1000	Indication Tray
	1420-1005	Indication Tray Base
	1420-1010	Indication Tray Insert
	1420-1020	Free Space Mat
	1500-0040	Full Size Tray Lid

*Existing part from the IMN Instruments System.

System components

Plus Indication specific instruments

	Ref #	Description
	1420-0005	Plus Indication Kit
	1420-0050	Opening Sleeve
	1420-0055	Opening Guide
	1420-0080	Opening Reamer
	1420-0120	Plus Targeting Arm
	1420-0125	Plus Nail Holding Screw
	1420-0110	Targeting Sleeve
	1420-0112	Targeting Sleeve Knob (spare part)
	1420-0190	Anti-Rotation Clip
	1420-0192	Anti-Rotation Sleeve
	1420-2100	Intermediate Targeting Sleeve
	1420-3010	RC Guide
	1420-3020	RC Inserter
	1420-0160	Lag Screw Sleeve
	1420-0220	Precision Sleeve™
	1420-0240	Lag Screw Reamer
	1420-0260	Lag Screw Driver
	1420-0270	Set Screw Driver
	1420-0300	Extraction Shaft
	2351-6000*	Opening Reamer Handle
	1320-0175	Final Impactor
	1420-1000	Indication Tray
	1420-1005	Indication Tray Base
	1420-1010	Indication Tray Insert
	1420-1020	Free Space Mat
	1500-0040	Full Size Tray Lid

*Existing part from the IMN Instruments System.

System components

IMN Basic instruments*

	Ref #	Description
	2356-0580	IM Nailing Basic Instruments Kit
	2351-0010	Curved Awl
	2351-0011	Awl Plug
	2351-0020	Reduction Rod
	2351-0030	Guide Wire Handle
	2351-0040	Ball Tip Screwdriver
	2351-0060	Slotted Hammer
	2351-0070	Tissue Protection Sleeve, Long
	2351-0100	Screwdriver Bit, Short
	2351-0101	Self-Retaining Screwdriver Sleeve, Short
	2351-0105	Screwdriver Bit, Medium
	2351-0106	Self-Retaining Screwdriver Sleeve, Medium
	2351-0110	Screwdriver Bit, Long
	2351-0140	Quick-Lock Delta Handle, Modified Trinkle
	2351-0150	Guided Depth Gauge
	2351-0160	Freehand Depth Gauge, Short
	2351-0170	Freehand Depth Gauge, Long
	2351-0340	Screw Scale
	2351-0380	Guide Wire Pusher
	2351-0420	X-ray Ruler
	2351-4280	Locking Drill Sleeve, Long
	2351-4290	Locking Trocar, Long
	2355-5000	Basic Instruments Tray
	2355-5005	Basic Tray Base
	2355-5010	Basic Tray Insert
	1500-0040	Full Size Tray Lid
	1806-0022	Guide Wire Ruler
	1806-0110	Universal Rod
	1806-0150	Strike Plate
	2351-0400	Compression Screwdriver (not required for Gamma4)
	2351-0180	Extraction Shaft (not required for Gamma4)

*Existing part from the IMN Instruments System.

System components

IMN Optional instruments*

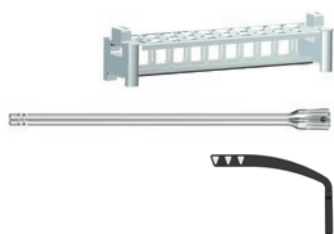

Ref #	Description
2351-0370	Reamer Head Tray Insert
2351-0111	Self-Retaining Screwdriver Sleeve, Long
2351-0240	One Shot Device

Gamma3® Optional instruments**



Ref #	Description
1320-0234	Set Screwdriver, Flexible
1320-0210	Set Screwdriver
1320-0225	Reduction Spatula
1320-0195	Lag Screw Tap
702628	T-Handle, AO Coupling
1320-0133	Paddle Trocar

Samples













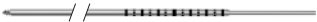

Ref #	Description	Dimensions
8125-0001X	Trochanteric Nail Sample Kit, Standard	Ø9 × 170mm × 125°
8125-0002X	Trochanteric Nail Sample Kit, RC	Ø9 × 170mm × 125°
8325-0001X	Intermediate Nail LEFT Sample Kit, Standard	Ø9 × 240mm × 125°
8325-0002X	Intermediate Nail LEFT Sample Kit, RC	Ø9 × 240mm × 125°
8525-0001X	Long Nail LEFT Sample Kit, Standard	Ø9 × 380mm × 125°
8525-0002X	Long Nail LEFT Sample Kit, RC	Ø9 × 380mm × 125°
8125-9170X	Trochanteric Nail Sample	Ø9 × 170mm × 125°
8325-9240X	Intermediate Nail LEFT Sample	Ø9 × 240mm × 125°
8525-9380X	Long Nail LEFT Sample	Ø9 × 380mm × 125°
8160-0100X	Lag Screw Sample	Ø10.5 × 100mm
8166-0100X	RC Lag Screw Sample	Ø10.5 × 100mm
2360-5040X	Locking Screw Sample	Ø5 × 40mm
2361-5040X	Advanced Locking Screw Sample	Ø5 × 40mm
8004-0000X	End Cap Sample	Ø11 × 0mm

*Existing part from the IMN Instruments System.





**Existing part from the Gamma3® System.

System components

Disposables

	Ref #	Description
	1420-0060S	Precision Pin™, Ø3.9mm × 450mm
	1420-0065S	Precision Pin™, tapered, Ø3.2/3.9mm × 450mm
	2351-4236S*	Locking Drill, Ø4.2 × 360mm
	2351-4218S*	Freehand Drill, Ø4.2 × 180mm
	2351-5500S*	Counterbore Drill, Short, Ø5.5 × 185mm
	2351-5510S*	Counterbore Drill, Long, Ø5.5 × 255mm
	2351-5515S*	Counterbore Drill, Manual, Ø5.5 × 280mm
	2351-0390S*	Locking Scalpel
	2351-3080S*	Guide Wire with Ruler Tube, Ø3 × 800mm
	2351-3082S*	Guide Wire, Ø3 × 800mm
	2351-3100S*	Guide Wire with Ruler Tube, Ø3 × 1000mm
	2351-3102S*	Guide Wire, Ø3 × 1000mm
	1320-0126S**	ADAPT Clip
	1210-6451S**	K-wire, Ø3.2mm × 450mm
	1420LVGA	SimpliFill

IMN Femur Antegrade Distal Targeting Instruments*

	Ref #	Description
	2356-0680	IM Nailing Femur Antegrade Distal Targeting Kit
	2353-3105	Adjusting Device Femur Antegrade
	2353-3106	Distal Targeting Arm Femur Antegrade
	2355-3050	Femur Antegrade Distal Targeting Tray
	1320-5395**	Oblique Alignment Wire, Gamma3® Distal Targeting, Ø3.2 × 180mm

*Existing part from the IMN Instruments System.

**Existing part from the Gamma3® System.

The information in the section is not intended to be used for sales and/or promotional purposes. This information is solely intended to be used as a reference for clinical usage.

This document is intended solely for the use of healthcare professionals. A surgeon must always rely on his or her own professional clinical judgment when deciding whether to use a particular product when treating a particular patient. Stryker does not dispense medical advice and recommends that surgeons be trained in the use of any particular product before using it in surgery.

The information presented is intended to demonstrate a Stryker product. A surgeon must always refer to the package insert, product label and/or instructions for use, including the instructions for Cleaning and Sterilization (if applicable), before using any Stryker product. Products may not be available in all markets because product availability is subject to the regulatory and/or medical practices in individual markets. Please contact your Stryker representative if you have questions about the availability of Stryker products in your area.

The Instructions for Use, Operative Techniques, Cleaning instructions, patient information leaflets and other associated labeling may be requested online at www.ifu.stryker.com or www.stryker.com.

If saving the Instructions for Use, Operative Techniques, Cleaning instructions from the above mentioned websites, please make sure you always have the most up to date version prior to use.

Stryker Corporation or its divisions or other corporate affiliated entities own, use or have applied for the following trademarks or service marks: Bixcut, Gamma3, Gamma4, Stryker. All other trademarks are trademarks of their respective owners or holders.

Content ID: G4-ST-1, Rev-3, 07-2023

Copyright © 2023 Stryker



Manufacturer:

Stryker GmbH
Bohnackerweg 1
2545 Selzach, Switzerland
Phone: +41 (0) 32 641 66 66
Fax: +41 (0) 32 641 66 60

stryker.com