



STERILIZABLE INTERNAL DEFIBRILLATION PADDLES

INSTRUCTIONS FOR USE

REF

11131-000040, 11131-000041, 11131-000042, 11131-000043, 11131-000044, 11131-000045,
11131-000046, 11131-000047

Contents

English

7

English

Introduction

These instructions provide information about using the Sterilizable Internal Defibrillation Paddles. This information includes instructions for connecting the internal paddles, performing pre-surgical functional tests, using the paddles to provide internal defibrillation, cleaning and sterilization procedures, and electronic testing procedures.

The operator should also read and understand the operating instructions provided with the LIFEPAK® defibrillator that will be used to provide internal defibrillation.

IMPORTANT! Read these instructions carefully before use, and keep for future reference.

Contents

Intended Use	9
Safety Information	9
Symbols	10
Basic Orientation	11
Compatible Defibrillators	12
Available Sizes	13
Care and Storage	13
Pre-Surgical Check	15
Internal Defibrillation Procedure	15
Internal Synchronized Cardioversion Procedure	17
Troubleshooting Tips	18
Continuity Test Procedures	19
Service	20
Service Life	20
Recycling Assistance	20
Cleaning Instructions (US/FDA)	21
Sterilization Instructions (US/FDA)	24
Cleaning Instructions (Alternate/CE)	26
Sterilization Instructions (Alternate/CE)	28
Sterilization Tracking	28

Intended Use

The Sterilizable Internal Defibrillation Paddles are intended for use with LIFEPAK defibrillators to internally detect ECG rhythm and provide defibrillation or synchronized cardioversion directly to the surgically exposed heart within a sterile use environment.

Indications

Defibrillation is indicated for the termination of certain potentially fatal arrhythmias, such as ventricular fibrillation and symptomatic ventricular tachycardia.

Synchronized cardioversion is indicated for the treatment of atrial fibrillation, atrial flutter, paroxysmal supraventricular tachycardia, supraventricular tachycardia, and in relatively stable patients, ventricular tachycardia.

Contraindications

Defibrillation is contraindicated in the treatment of Pulseless Electrical Activity (PEA), such as idioventricular or ventricular escape rhythms, and in the treatment of asystole.

Synchronized cardioversion is contraindicated in the treatment of Pulseless Electrical Activity (PEA) such as idioventricular or ventricular escape rhythms, asystole, and ventricular fibrillation.

Operator Training

This product should be used only by medical professionals with appropriate training, in a hospital setting.

Safety Information

The following terms are used in this manual to describe potential hazards:

Danger: Immediate hazards that will result in serious personal injury or death.

Warning: Hazards or unsafe practices that may result in serious personal injury or death.

Caution: Hazards or unsafe practices that may result in minor personal injury, product damage, or property damage.

Symbols

Danger

Fire or Explosion Hazard. Do not use the defibrillator in the presence of flammable gases or anesthetics. Use care when operating the defibrillator close to oxygen sources.

Warnings









- Possible Inability to Provide Therapy. Do not modify the internal defibrillation paddles.
 - Shock Hazard. Do not perform open-air discharges with the internal paddles.
 - Safety Risk and Possible Equipment Damage. The device is MR Unsafe. Keep it outside the magnetic resonance imaging (MRI) scanner room.
-





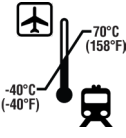

Note: The Sterilizable Internal Defibrillation Paddles are not intended for use with other manufacturers' defibrillators. Use only LIFEPAK defibrillators with these internal paddles.

The user and/or the patient should report any serious product-related incident to both the manufacturer and the local regulatory authority, such as the competent authority of the European Member State, where the user and/or patient is established.

Symbols

The following symbols may be found on the internal paddles or their packaging.

SYMBOL	DESCRIPTION
	Sterilizable internal defibrillation paddles
	Follow instructions for use. (Symbol on box has blue background and graphical symbol is white. Symbol on identification tag is gray.)
	Fragile/breakable. Handle with care.
	Protect from water
	Recommended shipping temperature: -40° to 70°C (-40° to 158°F)
	Type CF applied part
	The device is MR Unsafe. Keep it outside the magnetic resonance imaging (MRI) scanner room.
	Do not dispose of this product in the unsorted municipal waste stream. Dispose of this product according to local regulations. Visit strykeremergencycare.com/recycling for instructions on disposing of this product.
	Part number

SYMBOL	DESCRIPTION
	Catalog number
	Lot number (batch code)
IP36	Enclosure ingress protection code per IEC 60529
	Manufacturer
	Date of manufacture
	By prescription only
	For USA audiences only

Stryker or its affiliates own, use, or have applied for the following trademarks or service marks: LIFEPAK and Stryker. All other trademarks are trademarks of their respective owners or holders.

The absence of a product, feature, or service name, or logo from this list does not constitute a waiver of Stryker's trademark or other intellectual property rights concerning that name or logo.

Specifications are subject to change without notice.

Basic Orientation

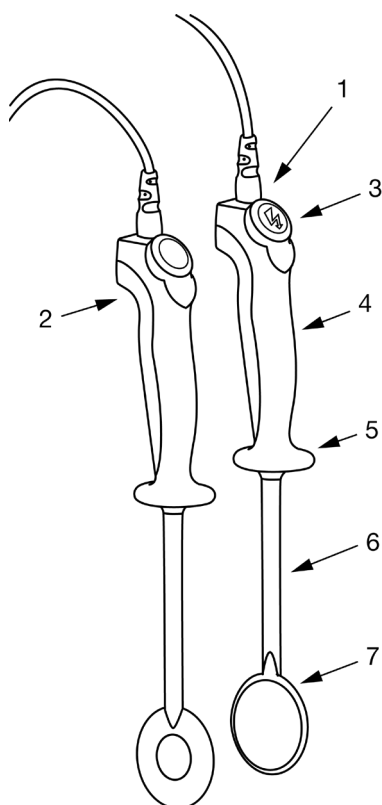

ITEM	DESCRIPTION
1	Right paddle
2	Left paddle
3	SHOCK button with Shock icon
4	Handle
5	Finger guard
6	Shaft
7	Electrode (Applied Part per IEC 60601-1)

An identification tag that contains required device identification information is attached to the internal paddles cable. This tag is designed to withstand cleaning and sterilization, and it should not be removed. Information on the tag can be used to track the internal paddles for purposes

Compatible Defibrillators

such as inventory management and sterilization tracking*. For ease of use, ensure the tag is kept away from the operative field.

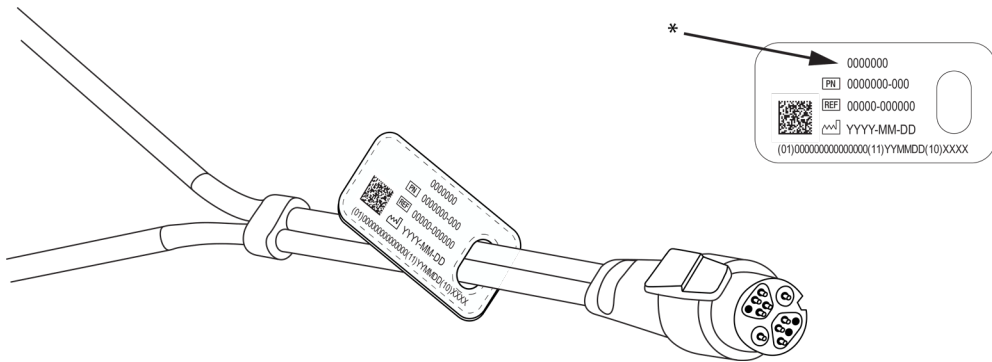

Compatible Defibrillators

The Sterilizable Internal Defibrillation Paddles are designed to be used with biphasic LIFEPAK defibrillators.

The internal paddles are available with either of two connector types, as shown in the following diagrams. Each of these connectors is for use with specific LIFEPAK defibrillator models. Before use, ensure that your internal paddles are compatible with your defibrillator.

Note: Connect internal paddles directly to the defibrillator. Do not use an adapter.

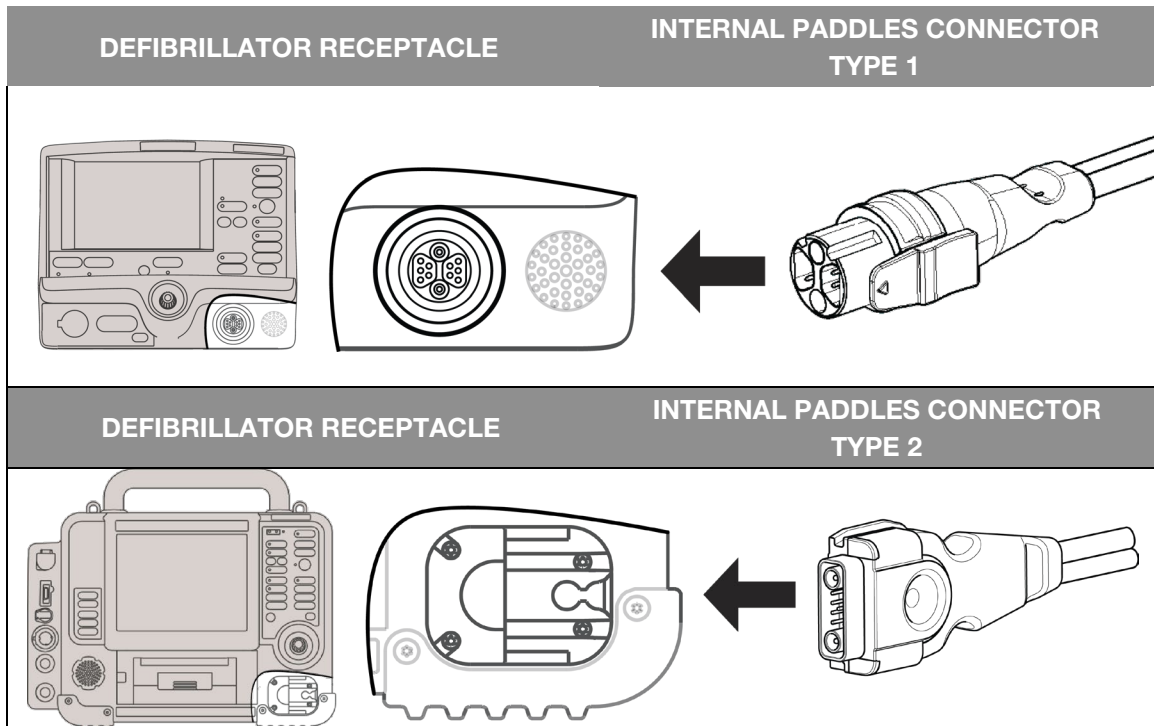

Available Sizes

Internal paddles are available in the sizes shown below. To order, contact your Stryker representative.

Potential adverse effects:

- Use of electrodes that are too large to fit fully within the chest cavity can cause injury to the surrounding tissue during defibrillation or synchronized cardioversion.
- Use of electrodes that are too small may concentrate the energy in one area during defibrillation or synchronized cardioversion which can cause myocardial injury.

Note: "Paddle Length" is the distance from the center of the electrode to the finger guard.

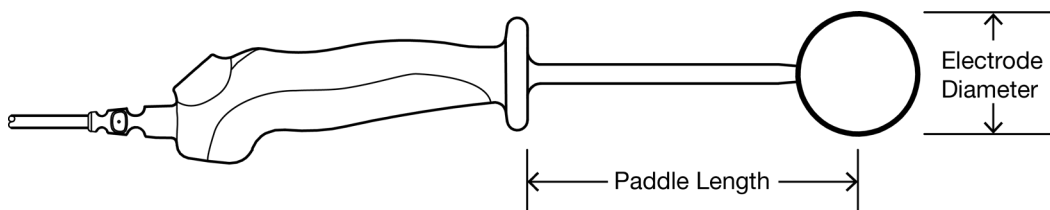

ELECTRODE DIAMETER		PADDLE LENGTH		CATALOG NUMBER	
CM	INCHES	CM	INCHES	TYPE 1	TYPE 2
2.5	1.0	14.2	5.6	11131-000040	11131-000044
4.1	1.6	15.0	5.9	11131-000041	11131-000047
5.8	2.3	16.0	6.3	11131-000042	11131-000045
7.6	3.0	16.8	6.6	11131-000043	11131-000046

IEC 60601-2-4:2010 designates the 7.6 cm (3.0 in) electrode for adult use, and the 5.8 cm (2.3 in) and 4.1 cm (1.6 in) electrodes for pediatric use. The 2.5 cm (1.0 in) electrode is available for use at the physician's discretion.

Care and Storage

Handling the Internal Paddles

Protect each paddle during handling to prevent damage.

- Keep the electrode surface moist with sterile water after exposure to blood or body fluids.
- Do not apply saline solution to the electrode surface.
- Immediately following use, cover each paddle with a damp cloth to help protect the paddles from impact with each other, other instruments, or sharp objects. Start wash procedure within one hour of use.
- Avoid dropping or bumping the paddles.
- Avoid transporting the paddles with sharp objects.
- Do not allow foreign materials to dry on the internal paddles.
- Do not wrap the cables around the handles. Damage may occur if cables have tight bends.

Continuity Tests

To ensure reliable performance, perform continuity tests of the connector pins before the internal paddles are sterilized for the first time. After the first sterilization cycle, perform continuity tests every 3 months or every 25 sterilization cycles, whichever occurs first. See Continuity Test Procedures (on page 19) for instructions.

After testing, clean and sterilize the internal paddles according to the instructions in this manual.

Sterilization

The internal paddles are shipped nonsterile. Clean and sterilize the paddles before the first use, after each time the paddles are used, and whenever the sterile packaging is compromised. See Cleaning Instructions (US/FDA) (on page 21) or Cleaning Instructions (Alternate/CE) (on page 26) for cleaning procedures. See Sterilization Instructions (US/FDA) (on page 24) or Sterilization Instructions (Alternate/CE) (on page 28) for sterilization procedures.

Caution

Possible Damage to Internal Paddles. Use **only one of the recommended sterilization methods** for the life of each internal paddles set. Using more than one sterilization method may invalidate the product certifications.

Storage Instructions

To prevent damage to the cables, always store internal paddles with the cables loosely coiled. The diameter of the coiled cable should be at least 15 cm (6 in).

Protect the paddle surfaces from impact with each other or hard surfaces to prevent possible damage and subsequent failure.

Long-term storage temperature: 0° to 45°C (32° to 113°F), or according to your facility's sterile product storage requirements.

After internal paddles are sterilized, store with sterilization wrapping intact. Internal paddles that are sterilized with STERRAD products should be stored in sterilization container systems such as wrapped, perforated, instrument cassettes in accordance with your facility's sterilization processing requirements and the sterilization equipment manufacturer's instructions. Sterilization wraps must be cleared by the FDA or approved by equivalent regulatory authority for your country, for the sterilization method used.

Note: Hydrogen Peroxide Vapor Sterilization has not been cleared for CE marking.

Pre-Surgical Check

Using sterile technique, perform the following steps before surgery to ensure the internal defibrillation paddles are ready for use. If any damage or malfunction is found, remove the internal paddles from use immediately.

Note: This table may be reproduced.

Step 1	Make internal paddles available for use within the sterile field. <ul style="list-style-type: none"> • Verify sterile packaging is dry and intact before opening.
Step 2	Inspect the following areas for deterioration or defects. <ul style="list-style-type: none"> • Handles—splitting at the seams • Connector—corroded, bent, or damaged pins • Cable junctions—exposed wires, gaps, or loose connections • Cables—cracks or exposed wires • SHOCK button—cracked or torn cover • Electrodes—pitted, chipped, or scratched surfaces; cracks in the plastic coating
Step 3	With paddles disconnected, press the SHOCK button located on the right handle and verify you can feel or hear the button click.
Step 4	Connect internal paddles to a compatible defibrillator. Turn the defibrillator on and verify energy of 50 joules or less appears on the screen.

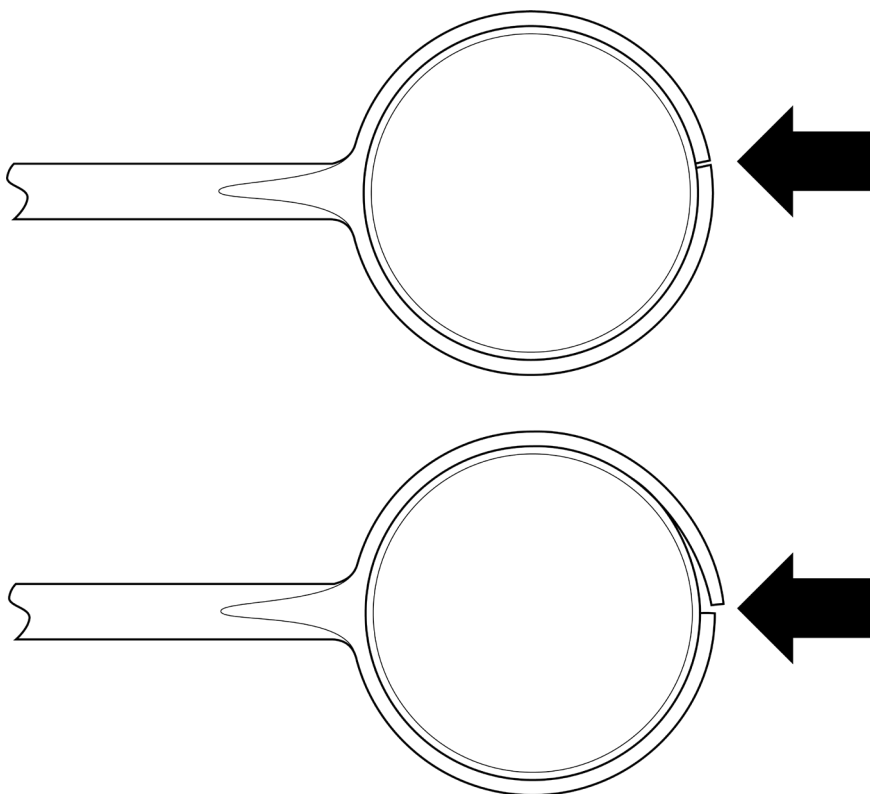

Examples of Paddle Damage

Internal Defibrillation Procedure

Energy selection is automatically limited to a range of 2–50 joules when internal paddles are connected.

To use internal paddles for defibrillation:

1. Connect the internal paddles to the LIFEPAK defibrillator.

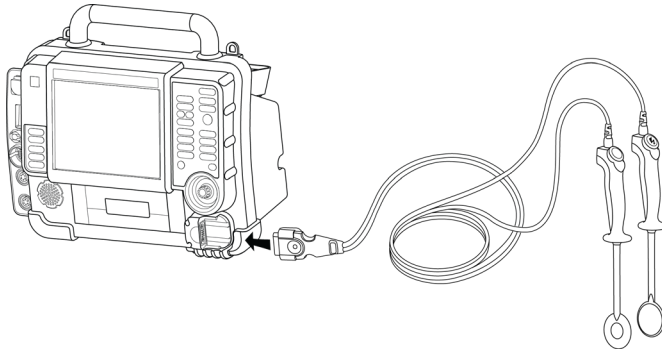

2. Turn the defibrillator on. Confirm that the internal defibrillation energy of 50 joules or less appears on the device display screen.

Note: The factory default setting is 10 joules.

3. If desired, select a different energy level. To select internal defibrillation energy levels, follow the directions in the Operating Instructions for the defibrillator, as below:

On the defibrillator, press **ENERGY SELECT** or rotate the **SPEED DIAL** to select the desired energy.

4. Charge the defibrillator.
5. Hold the paddles as shown, and place the conductive surface of the paddles against the patient's right atrium and left ventricle.

Note: Do not touch the area below the finger guard when using the internal paddles.



6. Make certain all personnel, including the operator, stand clear of the patient, operating table or bed, and any equipment connected to the patient.

7. When the defibrillator has reached the selected energy level, press the **SHOCK** button located on the handle of the right internal paddle. The defibrillator will not discharge until it completes charging to the selected energy level. If the **SHOCK** button is not pressed within 60 seconds, the stored energy is removed automatically.

Note: For safety reasons, the **SHOCK** button on the defibrillator is disabled when internal paddles are connected.

Internal Synchronized Cardioversion Procedure

Refer to the Operating Instructions provided with your LIFEPAK defibrillator for available **SYNC** mode settings. It is important to know how your defibrillator is configured.

Energy selection is automatically limited to a range of 2–50 joules when internal paddles are connected.

To use internal paddles for synchronized cardioversion:

1. Connect the internal paddles to the LIFEPAK defibrillator as shown in Internal Defibrillation Procedure (on page 15).
2. Turn the defibrillator on. Confirm that the internal defibrillation energy of 50 joules or less appears on the device display screen.

Note: The factory default setting is 10 joules.

3. If desired, select a different energy level.
4. Select **PADDLES** lead.
5. Change the ECG size (gain) to the lowest setting, 0.25.
6. Select **SYNC** mode.
7. Hold the paddles as shown in Internal Defibrillation Procedure, and place the conductive surface of the paddles against the patient's right atrium and left ventricle.
8. Confirm that a stable ECG signal is present and that triangle sense markers appear on the R-wave (near the middle of each QRS complex).

Note: The patient's ECG acquired through internal paddles may be unreliable for synchronized cardioversion due to excessive noise or artifact, causing inappropriate R-wave detection. If the sense markers do not appear or are displayed in the wrong location (for example, on the T-wave), acquire the patient's ECG through ECG electrodes connected to the LIFEPAK defibrillator.

9. Charge the defibrillator.
10. Make certain all personnel, including the operator, stand clear of the patient, operating table or bed, and any equipment connected to the patient.

11. When the defibrillator has reached the selected energy level, press and **hold** the **SHOCK** button located on the handle of the right internal paddle. Discharge will occur with the next detected QRS complex.

Note: For safety reasons, the **SHOCK** button on the defibrillator is disabled when internal paddles are connected.

12. Observe the patient's ECG rhythm.

13. If necessary, repeat Steps 6–12.

Troubleshooting Tips

These troubleshooting tips are specific to use of the internal paddles. For general troubleshooting tips, see the *Operating Instructions* for your LIFEPAK device.

OBSERVATION	POSSIBLE CAUSE	CORRECTIVE ACTION
Energy level does not appear on screen, or CONNECT CABLE message appears	Internal paddles not properly connected	<ul style="list-style-type: none"> Ensure all connections are firmly seated.
	Defibrillator in AED mode	<ul style="list-style-type: none"> Verify defibrillator is in manual mode.
	Bent or broken pin on internal paddles connector	<ul style="list-style-type: none"> Inspect internal paddles connector. Replace internal paddles if connector is damaged.
	Defective internal paddles or cable	<ul style="list-style-type: none"> Inspect internal paddles and cable. Replace if defective.
ABNORMAL ENERGY DELIVERY message appears	Electrodes not properly positioned on patient prior to discharge of energy	<ul style="list-style-type: none"> Position electrodes properly.
	Defective internal paddles or cable	<ul style="list-style-type: none"> Inspect internal paddles and cable. Replace if defective.
	Open-air discharge occurred	<ul style="list-style-type: none"> Do not discharge electrodes in the air.

Continuity Test Procedures

To ensure reliable performance, perform continuity tests of the connector pins before the internal paddles are sterilized for the first time. After the first sterilization cycle, perform continuity tests every 3 months or every 25 sterilization cycles, whichever occurs first.

The internal paddles contain no serviceable parts. If testing reveals a potential problem, remove the internal paddles from service and contact your local Stryker representative for assistance.

IMPORTANT!

- Use Universal Precautions when handling internal paddles that have not been sterilized.
- The internal paddles must be cleaned and sterilized after testing. See Cleaning Instructions (US/FDA) (on page 21), Cleaning Instructions (Alternate/CE) (on page 26), Sterilization Instructions (US/FDA) (on page 24), and Sterilization Instructions (Alternate/CE) (on page 28) for more information.

The internal paddles are available with either of two connector types. Use the following pin diagrams to determine which connector type you have.

To perform the continuity test:

1. Disconnect the internal paddles from the defibrillator.
2. Use a continuity tester, such as an ohm meter or a digital multimeter, to verify the resistance between the pins and electrodes as specified in the pin diagrams.

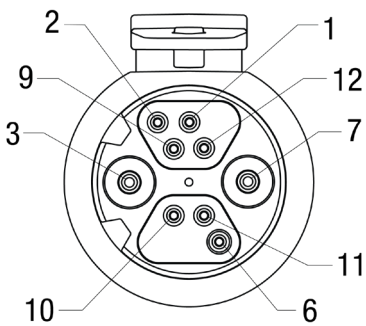
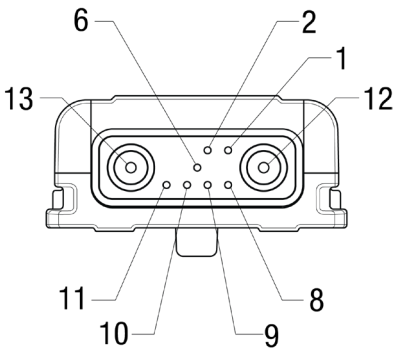
PIN DIAGRAM	TEST POINTS	VALUE
	Pin 7 to left electrode	< 1 Ω
	Pin 3 to right electrode	< 1 Ω
	Pin 1 to pin 2 with SHOCK button pressed	< 5 Ω
	Pin 1 to pin 2 with SHOCK button released	> 50 KΩ
	Pin 1 to pin 10	< 5 Ω
	Pin 1 to pin 11	< 5 Ω
	Pin 6 to pin 9	< 5 Ω
	Pin 6 to pin 12	< 5 Ω
PIN DIAGRAM	TEST POINTS	VALUE
	Pin 12 to left electrode	< 1 Ω
	Pin 13 to right electrode	< 1 Ω
	Pin 1 to pin 2 with SHOCK button pressed	< 5 Ω
	Pin 1 to pin 2 with SHOCK button released	> 50 KΩ
	Pin 1 to pin 10	< 5 Ω
	Pin 1 to pin 11	< 5 Ω
	Pin 6 to pin 8	< 5 Ω
	Pin 6 to pin 9	< 5 Ω

Service

The internal paddles contain no serviceable parts. If paddles do not function correctly, contact your local Stryker representative for assistance.

Service Life

The service life of the internal paddles may be affected by factors including, but not limited to, handling, cleaning and sterilization methods, and frequency of use. Always adhere to the Cleaning Instructions and Sterilization Instructions provided in this manual. The expected service life of the internal paddles is shown below and depends on the electrode size and sterilization method used. Regular use of prolonged exposure time and increased temperature may affect product life. One cycle is defined as a combined cleaning and sterilization process.

Expected Service Life

ELECTRODE SIZE	STERILIZATION PROCESSING METHOD		
	HYDROGEN PEROXIDE VAPOR*	PREVACUUM STEAM AT 132°C (270°F) FOR 4 MINUTES	PREVACUUM STEAM AT 137°C (279°F) FOR 18 MINUTES**
2.5 cm (1.0 in)	200 cycles	150 cycles	146 cycles
4.1 cm (1.6 in)	200 cycles	150 cycles	91 cycles
5.8 cm (2.3 in)	200 cycles	150 cycles	91 cycles
7.6 cm (3.0 in)	200 cycles	50 cycles	41 cycles

*Hydrogen Peroxide Vapor Sterilization has not been cleared for CE marking.

**Prevacuum Steam Sterilization at 137°C (279°F) for 18 minutes has not been cleared by the FDA.

To determine when to remove the internal paddles from service, inspect the internal paddles for deterioration or defects as described in the Pre-Surgical Check (on page 15), and perform electrical continuity tests as described in Continuity Test Procedures (on page 19). Perform inspection and testing throughout the life of the product. Remove the internal paddles from use if they do not meet the inspection or continuity test criteria.

Recycling Assistance

The device should be recycled according to national and local regulations. Contact your local Stryker representative for assistance or refer to strykeremergency.com/recycling.

Cleaning Instructions (US/FDA)

Follow the instructions in this document. Any deviation by the processor from the instructions provided should be evaluated for effectiveness and potential adverse consequences.

The internal paddles, including new paddles, must be thoroughly cleaned before sterilization. The internal paddles may become contaminated with infectious materials including bloodborne pathogens during use. Observe Universal Precautions and wear Personal Protective Equipment (PPE) when handling the internal paddles after use.

- The internal paddles may be cleaned either manually, or by use of an automated washer.
- Air used for drying should be filtered in accordance with local requirements.

Warning

Possible Ineffective Cleaning. These internal paddles must be cleaned using only the validated cleaning methods described. **Do not use any other cleaning method.**

Caution

Possible Damage to Internal Paddles. Do not use ultrasonic cleaners. Do not use abrasive cleaners.

Pre-Cleaning Inspection (US/FDA)

Before cleaning the internal paddles, follow the steps below.

1. Inspect the connector pins. If the pins are soiled, clean them carefully using cotton swabs moistened with isopropyl alcohol or hydrogen peroxide. If necessary, a soft nylon brush may be used to loosen any foreign materials. Do not use abrasive materials on the pins.
2. Inspect the following areas for deterioration or defects.
 - Handles—splitting at the seams
 - Connector—corroded, bent, or damaged pins
 - Cable junctions—exposed wires, gaps, or loose connections
 - Cables—cracks or exposed wires
 - **SHOCK** button—cracked or torn cover
 - Electrodes—pitted, chipped, or scratched surfaces; cracks in the plastic coating

If any of these are found, remove the internal paddles from use immediately.

Note: Sterilization may cause discoloration over time. This is normal and does not affect paddles function.

Procedures for manual and automated cleaning are provided in the following sections.

Manual Cleaning (US/FDA)

Note: The internal paddles may be cleaned either manually (see below) or using an automated washer as described in Automated Washer Cleaning (US/FDA) (on page 23).

To clean the internal paddles manually, follow the steps below. The internal paddles may be fully immersed, including cables and connector, if needed.

Step	Description	Duration	Fluid Type	Target Temperature
1. Inspection	Inspect internal paddles as described in Pre-Cleaning Inspection (on page 21)	Not applicable	Not applicable	Not applicable
2. Prewash	Rinse with water and gently use a soft brush, as needed, to remove visible soil while rinsing.	2 minutes	Tap water	< 16°C (61°F)
3. Enzyme Treatment	Soak	2 minutes or according to cleaner manufacturer's directions	Neutral pH enzymatic cleaner (Enzol® Enzymatic Detergent) prepared according to cleaner manufacturer's directions	Per cleaner manufacturer's directions, or < 43°C (109°F)
4. Wash	Wash, cleaning gently with a soft brush as needed	4 minutes total: <ul style="list-style-type: none"> • 2 minute soak • 2 minute scrub or until all visible soil has been removed 	Tap water with neutral pH detergent (Valsure® Neutral Detergent) prepared according to detergent manufacturer's directions	Per detergent manufacturer's directions, or < 43°C (109°F)
5. Rinse	Rinse entire device	9 minutes or until all visible detergent has been removed	Tap water	< 43°C (109°F)
6. Critical water rinse	Rinse entire device	4 minutes or until entire device has been rinsed	Critical water*	< 43°C (109°F)
7. Dry	Dry with filtered air	7 minutes or until no visible water is left on the device	Not applicable	≤ 116°C (241°F)
8. Inspection	Inspect internal paddles as described in Post-Cleaning Inspection (US/FDA) (on page 23)	Not applicable	Not applicable	Not applicable

*See AAMI TIR34:2014/(R)2017 for critical water specifications.

Automated Washer Cleaning (US/FDA)

Note: The internal paddles may be cleaned either using an automated washer (see below) or manually as described in Manual Cleaning (US/FDA) (on page 22).

To clean the internal paddles using an automated washer, follow the steps below.

1. Inspect internal paddles as described in Pre-Cleaning Inspection (Alternate/CE) (on page 21).
2. Place internal paddles in the washer according to your protocols and the washer manufacturer's instructions. The internal paddles may be fully immersed, including cables and connector. Water must be able to circulate freely around the paddles. Do not overcrowd the washer, and do not wrap cables around the paddles.
3. Wash internal paddles using the following automated washer parameters.

Cycle	Duration	Fluid Type	Target Temperature
Prewash	2 minutes	Tap water	< 16°C (61°F)
Enzyme Treatment	2 minutes	Hot tap water with treatment Enzol® Enzymatic Detergent (pH per automated washer protocol)	Per cleaner manufacturer's directions or 43° to 82°C (109° to 180°F)
Main Wash	2 minutes	Heated tap water with Valsure® Neutral Detergent (pH per automated washer protocol)	Per detergent manufacturer's directions or 66°C (151°F)
Rinse	9 minutes	Hot tap water	43° to 82°C (109° to 180°F)
Critical Water Rinse	4 minutes	Heated critical water*	66°C (151°F)
Dry	7 minutes or until no visible water is left on the device	Not applicable	≤ 116°C (241°F)

*See AAMI TIR34:2014/(R)2017 for critical water specifications.

4. Inspect internal paddles as described below in Post-Cleaning Inspection.

Post-Cleaning Inspection (US/FDA)

1. After the internal paddles have been cleaned, inspect the paddles to ensure that no visible soil remains. If any soil is found, repeat the cleaning procedure.
2. Inspect the internal paddles for deterioration or defects as described in step 2 of the Pre-Cleaning Inspection (US/FDA) (on page 21).

Sterilization Instructions (US/FDA)

Follow the instructions in this document. Any deviation by the processor from the instructions provided should be evaluated for effectiveness and potential adverse consequences.

The internal defibrillation paddles may be sterilized using the following sterilization methods:

- Prevacuum Steam
- Hydrogen Peroxide Vapor

Sterilization containers must be large enough to accommodate the size of the internal paddles and cable. The diameter of the coiled cable should be at least 15 cm (6 in).

Ensure the electrodes are positioned so that water cannot pool in the spoons during the sterilization cycle.

The useful life of internal defibrillation paddles is affected by the number of sterilization cycles rather than by the age of the paddles. The number of sterilization cycles should be tracked as described in Sterilization Tracking (on page 28).

Warning

Possible Ineffective Sterilization. These internal paddles may be sterilized using Prevacuum Steam or Hydrogen Peroxide Vapor sterilization methods. **Do not use any other sterilization method.**

Cautions

- Possible Damage to Internal Paddles. Use **only one of the recommended sterilization methods** for the life of each internal paddles set. Using more than one sterilization method may invalidate the product certifications.
 - Possible Damage to Internal Paddles. Coil the cable loosely away from the internal paddles for sterilization. Damage or ineffective sterilization may occur if the cable has tight bends or is wrapped around the handles. The diameter of the coiled cable should be at least 15 cm (6 in).
-

Prevacuum Steam Sterilization (US/FDA)

Use the following parameters for prevacuum steam sterilization.

Temperature and Exposure Time:	132°C (270°F) for 4 minutes
Preconditioning Pulses:	Minimum of 3
Prevacuum:	340 mBar (254 mmHg)
Wrapping:	Individually wrapped in two layers of 1-ply polypropylene wrap (Halyard Health H600) using sequential envelop techniques.*
Drying Time:	Minimum of 55 minutes (see note below).

Note: After sterilization is complete, inspect the packaging for signs of moisture on or within the packaging. Moisture on or within sterile packaging may signify a compromised sterile barrier and/or sterilization process failure. If moisture is observed on or within a sterile pack, repackage and re-sterilize with a longer dry time.

*Sterilization wraps must be cleared for the prevacuum steam sterilization by the FDA or approved by equivalent regulatory authority for your country.

Hydrogen Peroxide Vapor Sterilization (US/FDA)

The internal paddles may be sterilized using the following hydrogen peroxide sterilizers.

- STERRAD® 100 S (Short cycle)
- STERRAD NX (Advanced or Standard cycle)
- STERRAD 100 NX (Flex or Standard cycle)

Always follow the sterilizer manufacturer's instructions for packaging and processing. Validated sterilization procedures included in this manual used a STERRAD device with no modifications. Do not modify your sterilization device when following these validated instructions.

Individually wrap the internal paddles in two layers of 1-ply polypropylene wrap (Halyard Health H600) using sequential envelope techniques. Sterilization wraps must be cleared for hydrogen peroxide sterilization by the FDA or approved by equivalent regulatory authority for your country.

Cleaning Instructions (Alternate/CE)

Follow the instructions in this document. Any deviation by the processor from the instructions provided should be evaluated for effectiveness and potential adverse consequences.

The internal paddles, including new paddles, must be thoroughly cleaned before sterilization. The internal paddles may become contaminated with infectious materials including bloodborne pathogens during use. Observe Universal Precautions and wear Personal Protective Equipment (PPE) when handling the internal paddles after use.

- The internal paddles must be cleaned by use of an automated washer/disinfector compliant with ISO 15883.
- Air used for drying should be filtered in accordance with local requirements.

Warning

Possible Ineffective Cleaning. These internal paddles must be cleaned using only the validated cleaning methods described. **Do not use any other cleaning method.**

Caution

Possible Damage to Internal Paddles. Do not use ultrasonic cleaners. Do not use abrasive cleaners.

Pre-Cleaning Inspection (Alternate/CE)

Before cleaning the internal paddles, follow the steps below.

1. Inspect the connector pins. If the pins are soiled, clean them carefully using cotton swabs moistened with isopropyl alcohol or hydrogen peroxide. If necessary, a soft nylon brush may be used to loosen any foreign materials. Do not use abrasive materials on the pins.
2. Inspect the following areas for deterioration or defects.
 - Handles—splitting at the seams
 - Connector—corroded, bent, or damaged pins
 - Cable junctions—exposed wires, gaps, or loose connections
 - Cables—cracks or exposed wires
 - **SHOCK** button—cracked or torn cover
 - Electrodes—pitted, chipped, or scratched surfaces; cracks in the plastic coating

If any of these are found, remove the internal paddles from use immediately.

Note: Sterilization may cause discoloration over time. This is normal and does not affect paddles function.

Procedures for automated cleaning are provided in the following sections.

Automated Washer Cleaning (Alternate/CE)

The internal paddles must be cleaned using an automated washer/disinfector compliant with ISO 15883 (series). Manual Cleaning must not be used.

To clean the internal paddles using an automated washer, follow the steps below.

1. Inspect internal paddles as described in Pre-Cleaning Inspection (Alternate/CE) (on page 26).
2. Clean the internal paddles within one hour of use.
3. Place internal paddles in the washer according to your protocols and the washer manufacturer's instructions. The internal paddles may be fully immersed, including cables and connector. Water must be able to circulate freely around the paddles. Do not overcrowd the washer, and do not wrap cables around the paddles.
4. Wash internal paddles using the following automated washer parameters.

Cycle	Duration	Fluid Type	Target Temperature
Prewash	2 minutes	Tap water	16°C (61°F)
Main Wash	2 minutes	Heated tap water with detergent neodisher® MediClean forte Alkaline-based detergent (pH10.4-10.8)	Per detergent manufacturer's directions 40° to 60°C (104°F to 140°F) or 45°C (113°F)
Rinse	9 minutes	Hot tap water	82°C (180°F)
Purified Water Rinse	4 minutes	Heated purified water*	66°C (151°F)
Disinfect	5 minutes	Heated purified water*	90°C (194°F)
Dry	7 minutes or until no visible water is left on the device	Not applicable	116°C (241°F)

*Use purified water, highly purified water, or sterile water with less than 10 cfu/ml and 0.25 EU/ml.

Thermal disinfection was validated for the Automated Cleaning cycle. Both A₀600 (90°C/1 minute) and A₀3000 (90°C/5 minute) have been validated as effective for disinfection.

5. Inspect internal paddles as described below in Post-Cleaning Inspection.

Post-Cleaning Inspection (Alternate/CE)

1. After the internal paddles have been cleaned, inspect the paddles to ensure that no visible soil remains. If any soil is found, repeat the cleaning procedure.
2. Inspect the internal paddles for deterioration or defects as described in step 2 of the Pre-Cleaning Inspection (Alternate/CE) (on page 26).

Sterilization Instructions (Alternate/CE)

Follow the instructions in this document. Any deviation by the processor from the instructions provided should be evaluated for effectiveness and potential adverse consequences.

The internal defibrillation paddles may be sterilized using the following sterilization method:

- Prevacuum Steam (active, dynamic air-removal with saturated steam according to ISO 17665)

Sterilization containers must be large enough to accommodate the size of the internal paddles and cable. The diameter of the coiled cable should be at least 15 cm (6 in).

Ensure the electrodes are positioned so that water cannot pool in the spoons during the sterilization cycle.

The useful life of internal defibrillation paddles is affected by the number of sterilization cycles rather than by the age of the paddles. The number of sterilization cycles should be tracked as described in Sterilization Tracking (on page 28).

Warning

Possible Ineffective Sterilization. These internal paddles may be sterilized using Prevacuum Steam sterilization. **Do not use any other sterilization method.**

Caution

Possible Damage to Internal Paddles. Coil the cable loosely away from the internal paddles for sterilization. Damage or ineffective sterilization may occur if the cable has tight bends or is wrapped around the handles. The diameter of the coiled cable should be at least 15 cm (6 in).

Prevacuum Steam Sterilization (Alternate/CE)

Use the following parameters for prevacuum steam sterilization (active, dynamic air-removal with saturated steam according to ISO 17665-1).

Temperature:	132° to 137°C (270° to 279°F)*
Exposure Time:	4 to 18 minutes*
Preconditioning Pulses:	Minimum of 3
Prevacuum:	340 mBar (254 mmHg)
Steam (quality):	Use purified water, highly purified water, or sterile water with less than 10 cfu/ml and 0.25 EU/ml
Wrapping:	Individually wrapped in two layers of 1-ply polypropylene wrap (Halyard Health H600) using sequential envelop techniques.**
Drying Time:	Minimum of 55 minutes

*For CE mark countries in the European Union, sterilization should be performed at 134°C (273°F). Prevacuum steam sterilization is validated up to an exposure time of 18 minutes and a temperature of 137°C (279°F), if mandated by local requirements. To avoid product damage, do not exceed these values.

**Sterilization wraps must be cleared for the prevacuum steam sterilization by the FDA or approved by equivalent regulatory authority for your country per ISO 11607-1.

Sterilization Tracking

The internal paddles should be thoroughly tested at least once every 3 months or every 25 sterilization cycles, whichever occurs first. See Continuity Test Procedures (on page 19) for information about testing.

To ensure that testing is performed when required, sterilization cycles should be tracked. A sterilization tracking log is provided below. The tracking log may be reproduced.

TRACKING CODE*	DATE OF STERILIZATION CYCLE				
	1	2	3	4	5
	6	7	8	9	10
	11	12	13	14	15
	16	17	18	19	20
	21	22	23	24	25
Perform continuity tests after 25 cycles or 3 months.					
	1	2	3	4	5
	6	7	8	9	10
	11	12	13	14	15
	16	17	18	19	20
	21	22	23	24	25
Perform continuity tests after 25 cycles or 3 months.					
	1	2	3	4	5
	6	7	8	9	10
	11	12	13	14	15
	16	17	18	19	20
	21	22	23	24	25

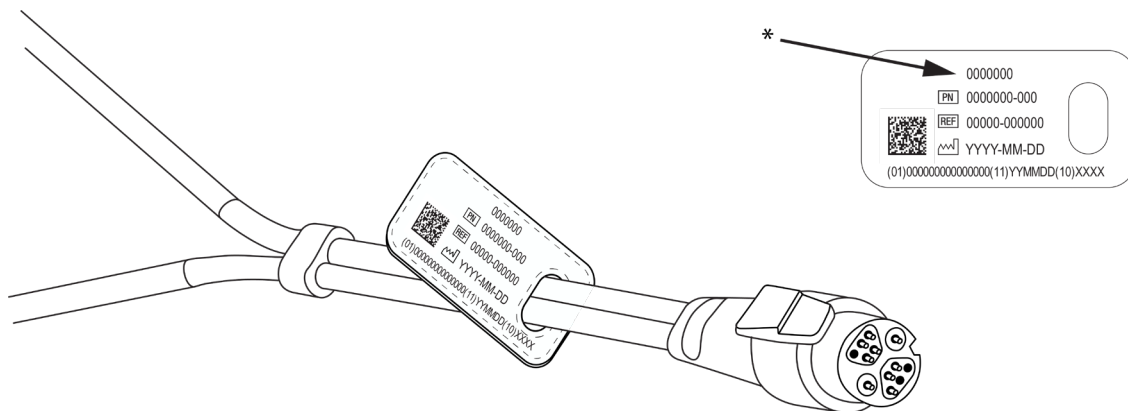

Stryker
Emergency Care
P.O. Box 97006
Redmond, WA 98073-9706 USA
+ 1 800 STRYKER
+ 1 800 787 9537
+ 1 425 867 4000
stryker.com

Stryker Australia Pty Ltd
8 Herbert Street
St Leonards
NSW 2065
Australia



Physio-Control, Inc., 11811 Willows Road NE, Redmond, WA 98052