

stryker

Infinity[®]

with Adaptis[®] Technology

Operative technique



Infinity

with Adaptis Technology

Operative technique

Surgeon design team

The Infinity with Adaptis Technology Total Ankle System was developed in conjunction with:

Robert B. Anderson, MD
OrthoCarolina
Charlotte, NC

Gregory C. Berlet, MD
Orthopedic Foot and Ankle Center
Columbus, OH

W. Hodges Davis, MD
OrthoCarolina
Charlotte, NC

Steven L. Haddad, MD
Illinois Bone and Joint Institute
Chicago, IL

William C. McGarvey, MD
Houston Orthopedic and Spine Hospital
Houston, TX

Murray J. Penner, MD FRCSC
Providence Health Care
Vancouver, BC

Disclaimer

This publication sets forth detailed recommended procedures for using Stryker devices and instruments. It offers guidance that you should heed, but, as with any such technical guide, each surgeon must consider the particular needs of each patient and make appropriate adjustments when and as required.

Important

- The patient should be advised that the device cannot and does not replicate a normal healthy bone, that the device can break or become damaged as a result of strenuous activity or trauma and that the device has a finite expected service life.
- Removal or revision of the device may be required sometime in the future.
- Cleaning and sterilization information is provided in the applicable instructions for use.
- Non-sterile devices, including implants and instruments, must be cleaned and sterilized prior to use, in accordance with validated methods.
- Devices that are able to be disassembled should be disassembled prior to point-of-use processing.
- Additionally, devices with movable components that do not facilitate disassembly should be manually articulated during the point-of-use processing step in order to evacuate additional soils.
- Please remember that the compatibility of different product systems has not been tested unless specified otherwise in the product labeling.
- Consult Instructions for Use (www.ifu.stryker.com) for a complete list of potential adverse effects and adverse events, contraindications, warnings and precautions.
- The surgeon must advise patients of surgical risks, and make them aware of adverse effects and alternative treatments.
- An implant whose packaging is open or damaged or whose expiration date has passed must not be used. Every precaution must be taken to ensure sterility when opening the packaging of the implant and during implantation.

Infinity

with Adaptis Technology

Contents

Product information	6	Polyethylene thickness	40
Intended use.....	6	Talar peg drilling.....	41
Indications	6	Tibial component implantation.....	42
Contraindications.....	6	Talar component implantation.....	45
Preoperative planning	7	Polyethylene bearing installation.....	46
Operative technique	8	Explant information	50
Surgical approach	8	Postoperative management	50
Set axial rotation.....	8	Appendix A	51
Attach alignment frame.....	9	Infinity with Adaptis Technology flat cut talar dome	51
Coronal plane (varus/valgus) alignment	11	Bone resection.....	51
Set sagittal plane (flexion/extension) alignment	15	Bone removal & tibial preparation.....	53
Install sizing and resection guide adjustment block	18	Implanting tibial tray	53
Coronal plane sizing and positioning.....	19	Verify talar dome size	54
Sagittal plane sizing and resection height	22	Trial reduction	55
Drill tibial corners	26	Talar preparation	56
Bone resection.....	27	Install talar dome.....	57
Remove tibial bone resection	29	Install poly insert.....	57
Tibial tray trialing and AP sizing	30	Appendix B	58
Tibial peg broaching	33	Talar Re-Cut Option.....	58
Talar component sizing and positioning.....	34	Appendix C	59
Talar chamfer resections	36	Infinity with Adaptis Technology Instrumentation.....	59
		Appendix D	69
		Ordering Information	69

Introduction



General product information

Through the advancement of partial and total joint replacement, the surgeon has been provided with a means of restoring mobility, correcting deformity, and reducing pain for many patients. While the prostheses used are largely successful in attaining these goals, it must be recognized that they are manufactured from a variety of materials and that any joint replacement system, therefore, cannot be expected to withstand activity levels and loads as would normal healthy bone. In addition, the system, including the implant/bone interface, will not be as strong, reliable, or durable as a natural human joint.

Ankle joint replacement components consist of a talar dome, a tibial platform, and an UHMWPE component. Components are available in a variety of sizes and design configurations intended for primary applications.

The Infinity with Adaptis Technology tibia tray and talar dome are manufactured using an improved process known as Direct Metal Laser Sintering (DMLS). DMLS, also known as Adaptis 3D printing, produces a porous metal surface made from Ti6Al4V (Tibia Tray) and CoCr (Talar Dome), respectively, to interface with the bone.

The Infinity with Adaptis Technology modular articular inserts are manufactured from everlast highly crosslinked polyethylene blended with Vitamin E.

Indications and contraindications

Intended use

The Infinity with Adaptis Technology Total Ankle System is intended to give a patient limited mobility by reducing pain, restoring alignment and replacing the flexion and extension movement in the ankle joint.

Indications

The Infinity with Adaptis Technology Total Ankle System is indicated for patients with ankle joints damaged by severe rheumatoid, post-traumatic, or degenerative arthritis.

Contraindications

Contraindications include:

1. Osteomyelitis;
2. Insufficient bone stock or bone quality;
3. Infection at the ankle site or infections at distant sites that could migrate to the ankle;
4. Sepsis;
5. Vascular deficiency in the lower leg;
6. Skeletally immature patients (patient is less than 21 years of age at the time of surgery);
7. Cases where there is inadequate neuromuscular status (e.g., prior paralysis, fusion and/or inadequate abductor strength), poor skin coverage around the joint which would make the procedure unjustifiable;
8. Neuropathic joints;
9. Excessive loads as caused by activity or patient weight;
10. Patient pregnancy;
11. Severely compromised musculature or neuromuscular function;
12. Uncooperative patient or patient with neurologic disorders, incapable of following instructions

WARNING

This device is not intended for subtalar joint fusion or subtalar joint impingement. Please carefully evaluate the anatomy of each patient before implantation. High levels of activity may increase the risk of adverse events. Surgeons should carefully consider the advisability of ankle replacement in patients with metabolic disorders or pharmacological treatments that impair bone formation or with conditions that may impede wound healing (e.g., end stage diabetes or malnutrition).

Prior to use of the system, the surgeon should refer to the product package insert for complete warnings, precautions, indications, contraindications and adverse effects. Package inserts are also available by contacting the manufacturer. Contact information can be found on the back of this surgical technique and the package insert is available on the website listed.

Preoperative planning

Preoperative assessment of the appropriate size and position of the tibial and talar components will provide intraoperative guidance for component selection.

Radiographic overlays for the Infinity with Adaptis Technology Total Ankle System are available in 0% and 10% magnification, and represent both the AP and Lateral profile of the prosthesis.

 **CAUTION**

Preoperative templating is intended for estimation purposes only. Final component size and position should be determined intraoperatively through direct visualization under fluoroscopic assistance.

Operative technique

Surgical approach

Make the anterior incision centered on the ankle, directly lateral to the palpable tibialis anterior tendon and medial to the extensor hallucis longus tendon. Define and avoid the deep peroneal nerve and anterior tibial artery. Once the nerve bundle is mobilized, the anterior ankle (distal tibia and talus) is exposed with the dorsal talonavicular joint representing the distal extent of the incision. This incision can be modified according to the specific needs of the patient.

Insert the medial gutter fork (33600009 or 33600010) into medial gutter of the ankle joint, roughly perpendicular to the axis of the tibia. Ensure it is placed deep into the medial gutter, as this will establish the ultimate axial rotation of the prosthesis (fig. 1 and fig. 2).



Fig. 1

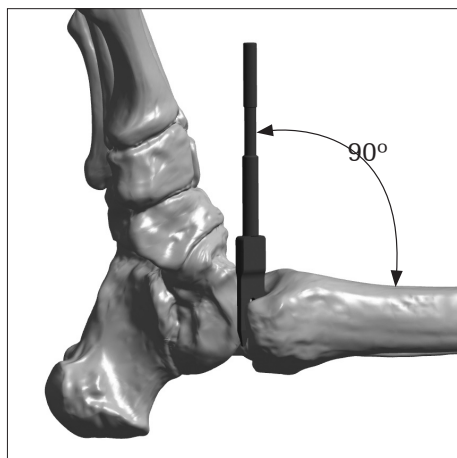

Fig. 2



Medial gutter fork
Small: 33600009
Large: 33600010

Set axial rotation

Assemble the rotation guide pointer (33600011) and the rotation guide slide (33600012) and install over the end of the medial gutter fork (fig. 3). Slide the rotation guide pointer medial/lateral to reach the approximate center of the tibia. Rotate the rotation guide slide about the gutter fork until the pointer is aligned approximately to the mechanical axis of the tibia.

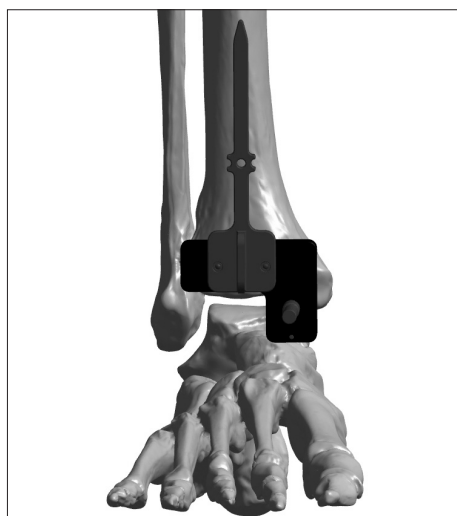

Fig. 3



Rotation guide pointer
33600011



Rotation guide slide
33600012

Operative technique

Install a 3.2mm pin (33610001) through the hole in the rotation guide pointer and through both cortices (fig. 4) Then remove the pointer, slider, and gutter fork (fig. 5).

Attach alignment frame

Assemble the alignment frame by sliding the end of the proximal alignment frame sub-assembly (33600021) into the distal alignment frame sub-assembly (33600020). Slide the alignment frame over the distal pin (fig. 6) And align the proximal end to the proximal tibia. Install a 3.2mm pin percutaneously through the proximal hole of the alignment frame into the tibial tuberosity. Turn the most proximal knob to loosely lock the frame to the pin (fig. 7).

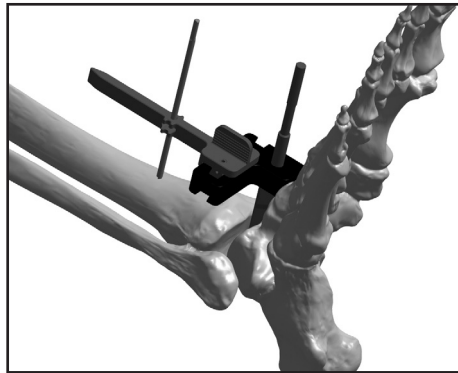

Fig. 4

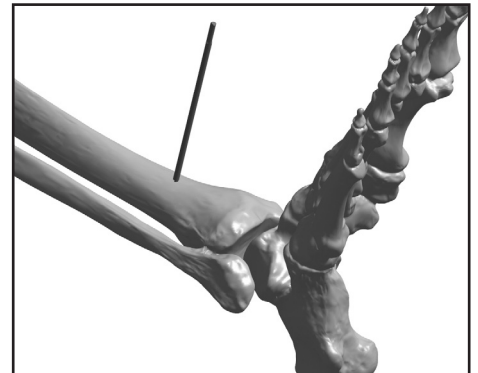

Fig. 5

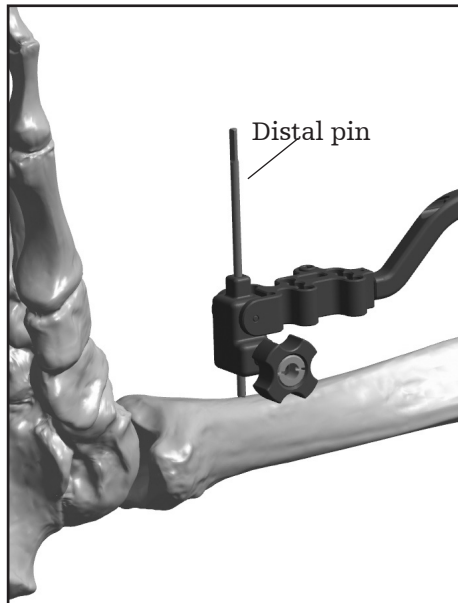

Fig. 6

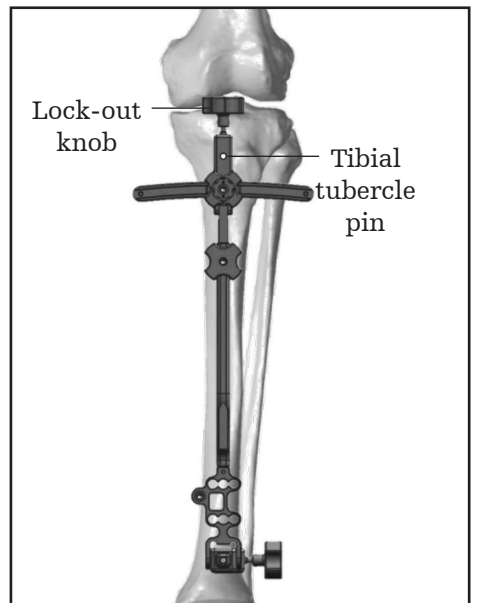

Fig. 7



Proximal alignment frame sub-assembly
33600021



Distal alignment frame sub-assembly
33600020

Operative technique

As an alternative to placing a pin in the proximal tibia, the knee bracket (33600022) and rubber strap (200430) can be used. For this method, first slide the knee bracket post into the proximal hole of the alignment frame (fig. 8) Then position the knee bracket over the proximal end of the tibia and secure in place using the rubber strap.

In order to provisionally set the height of the alignment frame upon the distal pin, place two fingers between the distal portion of the frame and the distal tibial crest (approximately 20 to 25mm). Then lock the most distal knob (fig. 9).

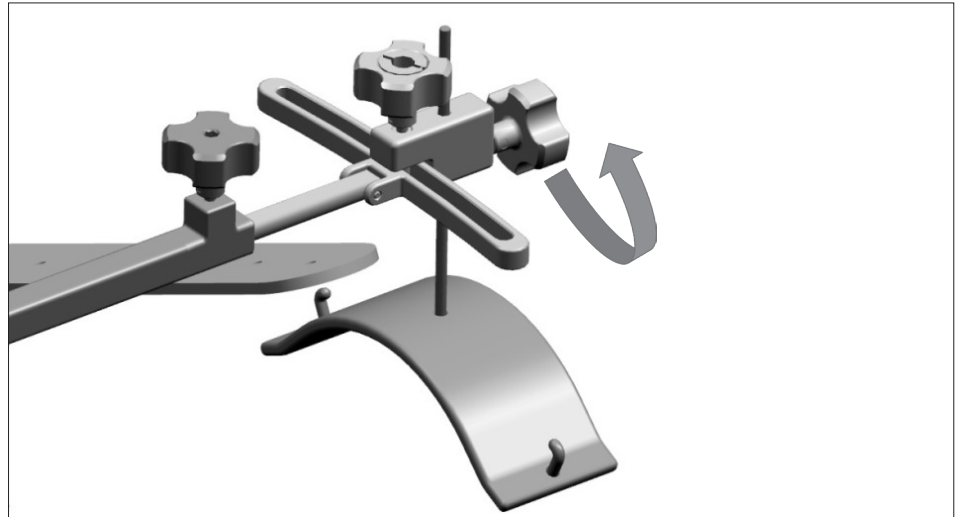

Fig. 8



Knee bracket
33600022

Rubber strap
200430

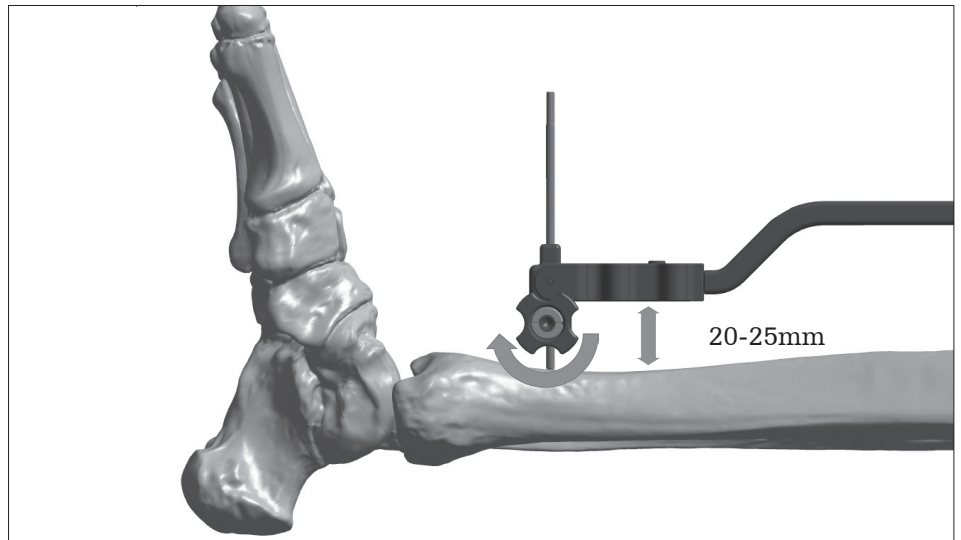

Fig. 9

Operative technique

Coronal plane (varus/valgus) alignment

Attach the alignment wing guide (33600023) onto the alignment frame and secure with the hex driver (E5001005) and set screw (fig. 10-11). Loosen the set screw to allow proximal/distal adjustment of the alignment wing.

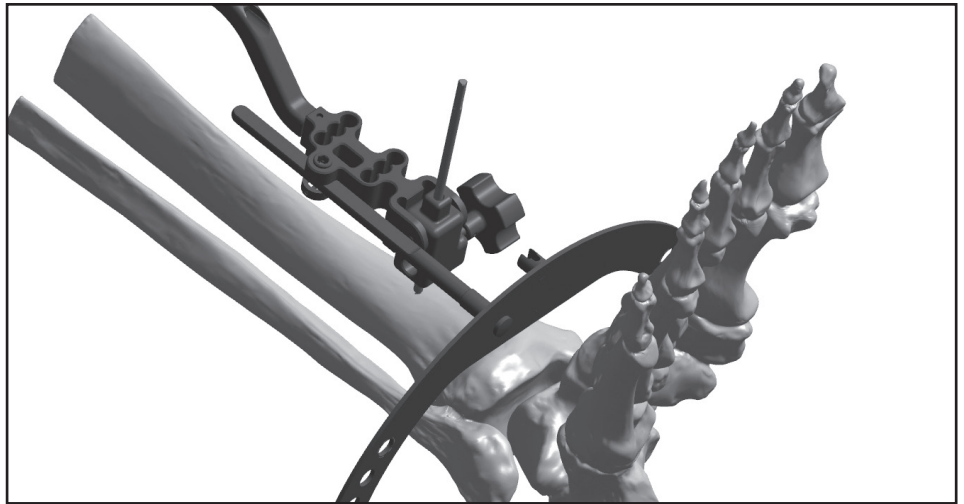

Fig. 10

CAUTION

It is important to ensure the arm of the alignment wing is assembled flush to the alignment frame (fig. 11-12).



Alignment wing guide
33600023



Hex Driver
E5001005

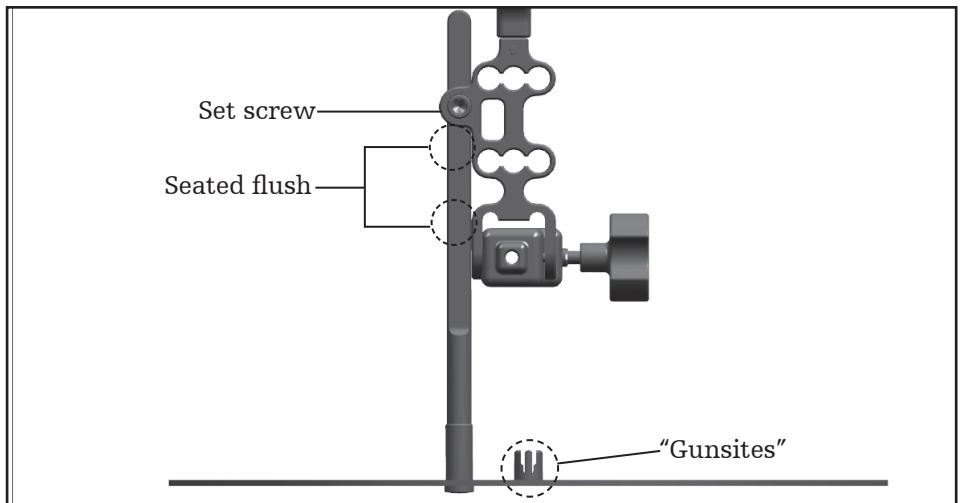

Fig. 11

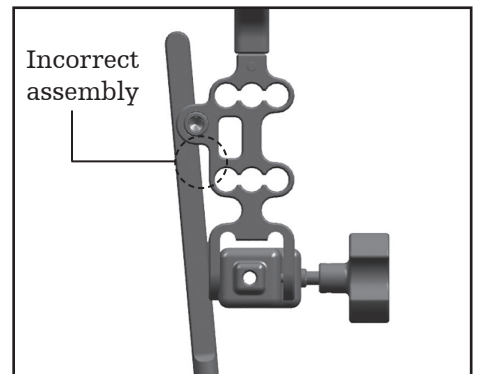

Fig. 12

Operative technique

There are two separate parallax cues for establishing a true fluoroscopic view in the coronal plane.

1. A set of “gun sites” are located on the alignment wing (fig. 13-14). To get these lined up correctly, make very small “rainbow” or orbital adjustments with the c-arm. Alternatively the surgeon can internally/externally rotate the leg.
2. The width of the alignment wing should appear as a thin uniform line (fig. 16). If it does not (fig. 15) Slightly “tilt” the c-arm to adjust. Alternatively the surgeon can raise/lower the foot.

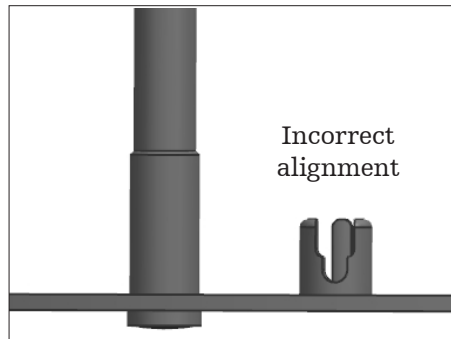

Fig. 13

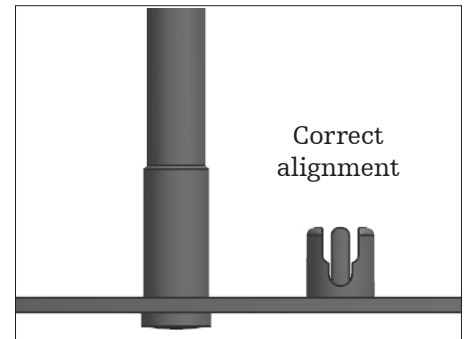

Fig. 14

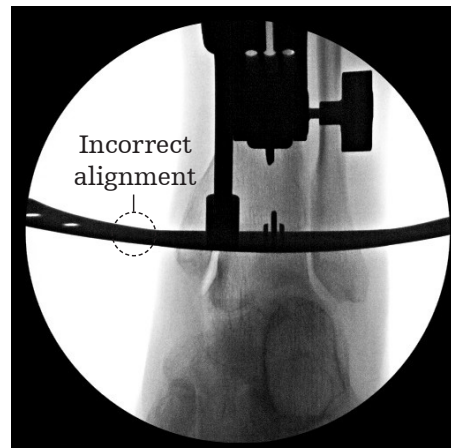

Fig. 15

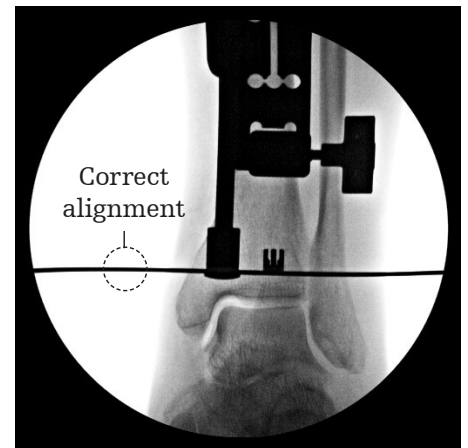

Fig. 16

Operative technique

The alignment frame can now be adjusted to establish coronal rotation (varus/valgus). Loosen the grey color-coded knob at the proximal end of the alignment frame to adjust coronal rotation (fig. 17). Tighten knob when adjustment is set.

Under A/P fluoroscopy use the position of the alignment wing to establish desired coronal alignment (fig. 18-19).

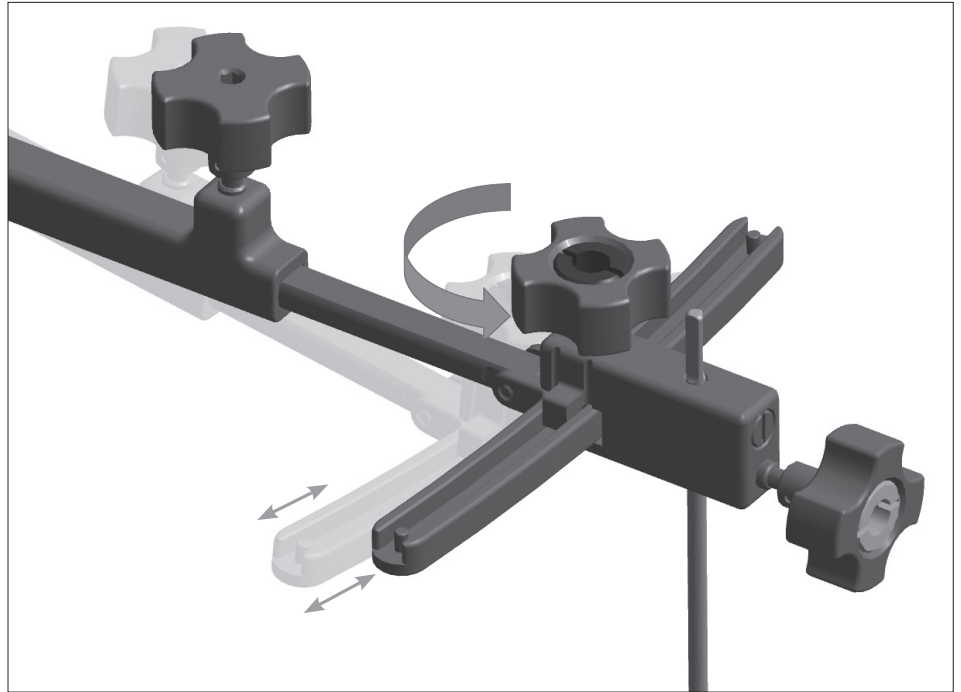

Fig. 17

Alternately, for a coronal fluoroscopic rotational reference, the surgeon can attach the coronal alignment rod (33600027) to the alignment wing. Attach by sliding the base of the rod over the wing, with the rod pointing proximally. Thread down the rod to clamp down on the wing.

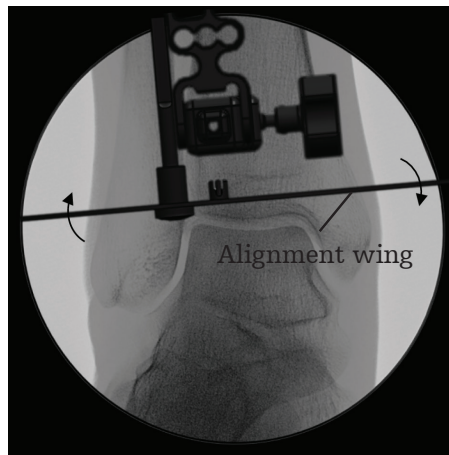

Fig. 18

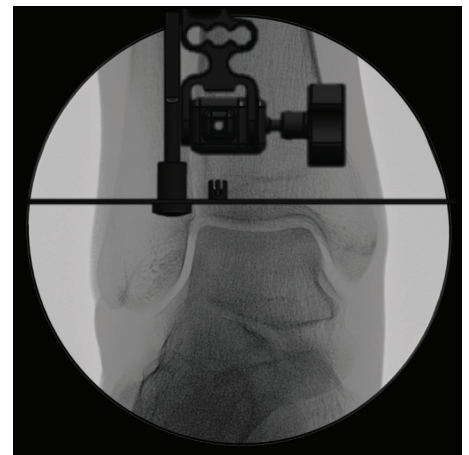

Fig. 19



Coronal Alignment Rod
33600027

Operative technique

Typically, the distal tibial resection is set perpendicular to the mechanical axis of the tibia in the coronal plane (i.e. Varus/valgus alignment). In many cases, the mechanical axis and the distal tibial anatomic axis are near parallel, and the tibial plafond is perpendicular to these axes. In these cases, the long axis of the external alignment frame may be aligned to the mechanical or anatomic axis by placing the alignment wing parallel to the distal tibial plafond (fig. 20).

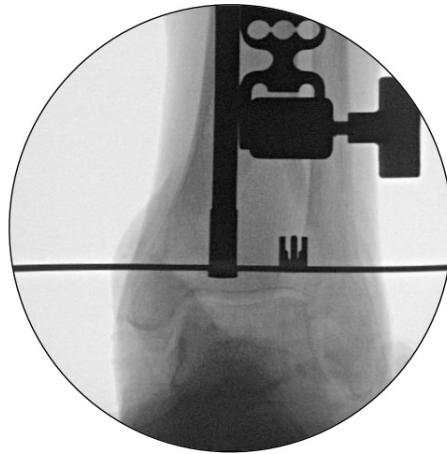

Fig. 20

In situations where the distal tibial anatomic axis is not parallel to the mechanical axis (fig. 21), or the tibial plafond is not perpendicular to the mechanical axis, coronal plane alignment is typically achieved by aligning the external alignment frame to the mechanical axis by visualizing the position of the frame relative to the full length of the tibia with the c-arm (fig. 22).

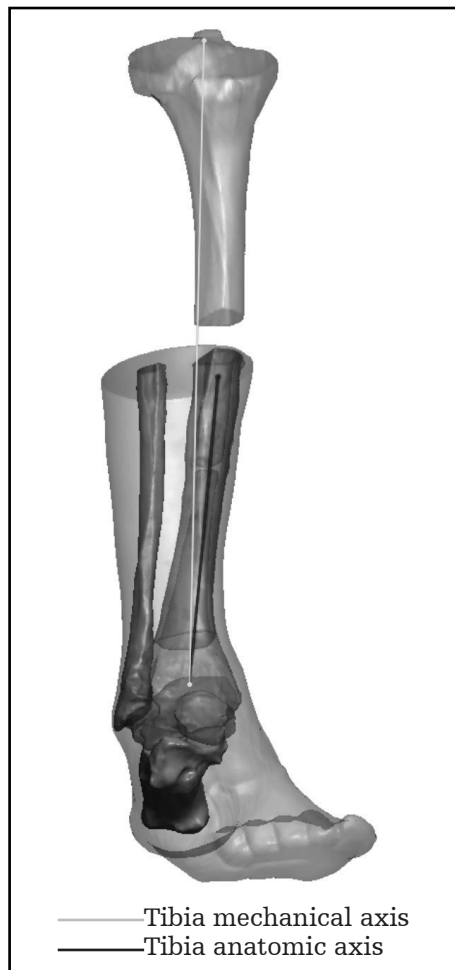

Fig. 21

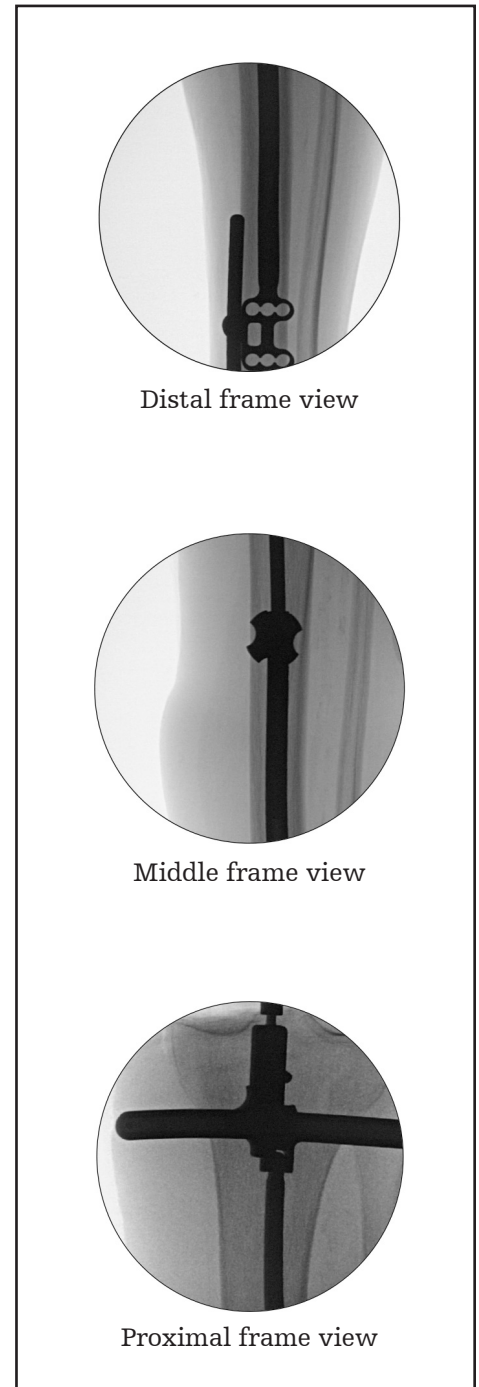

Fig. 22

Operative technique

It is important to realize that parallax from the image intensifier may distort the perceived position of the alignment rod. The surgeon must be cognizant of this. As such, the surgeon must study the preoperative radiographs to determine the appropriate coronal plane alignment, determining the varus/valgus alignment of the alignment wing with reference to the tibial plafond based on these radiographs. Views of the entire tibia, or entire limb (hip/knee/ankle), may be necessary to determine this alignment. Using this information, the blade may not be parallel to the tibial plafond, and the surgeon may resect more bone medially or laterally with the joint depending on the deformity encountered.

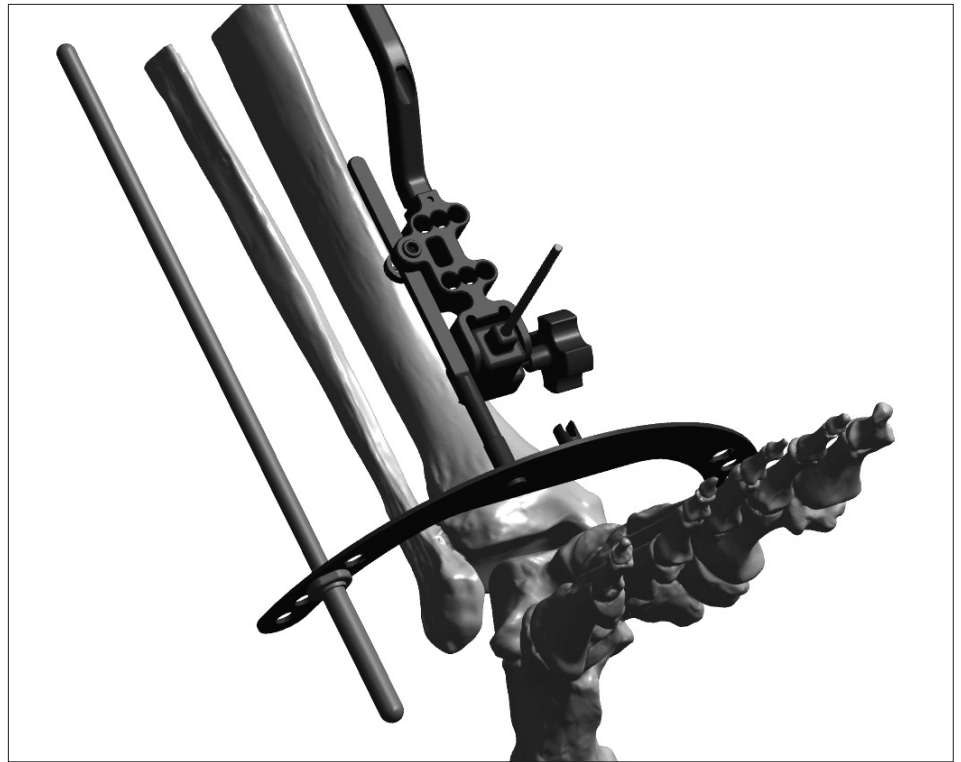

Fig. 23

Set sagittal plane (flexion/extension) alignment

Assemble the alignment rod (33600024) into one of the four holes in either side of the alignment wing (fig. 23). Choose a hole that will allow visualization of both the rod and the tibia in the sagittal plane.



Alignment rod
33600024

Operative technique

To establish a true lateral fluoroscopic view, adjust the c-arm until the alignment wing appears as one solid thin line. If there is appearance of a double line, (fig. 24), Adjust the position of the leg or c-arm until the two lines become one (fig. 25).

To adjust the flexion angle of the prosthesis with respect to the distal tibia, loosen either of the two aqua color-coded knobs. Knobs are located on both the proximal and distal end of the frame (fig. 26-27).

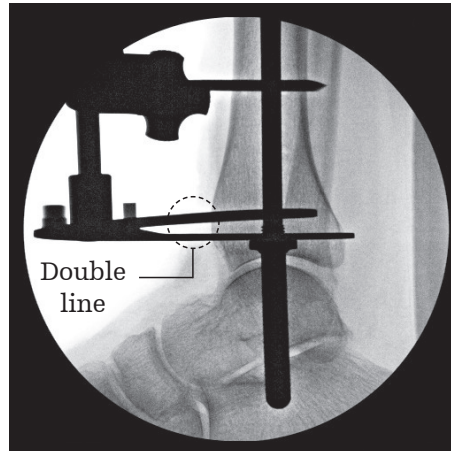

Fig. 24

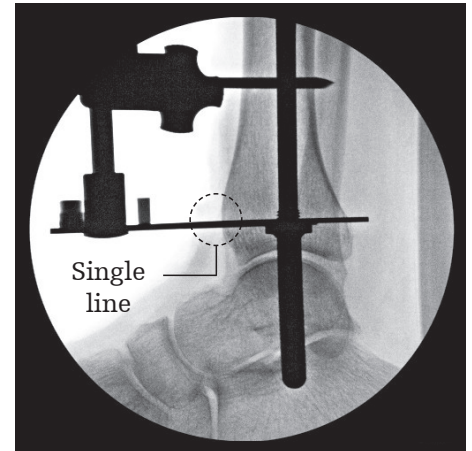

Fig. 25

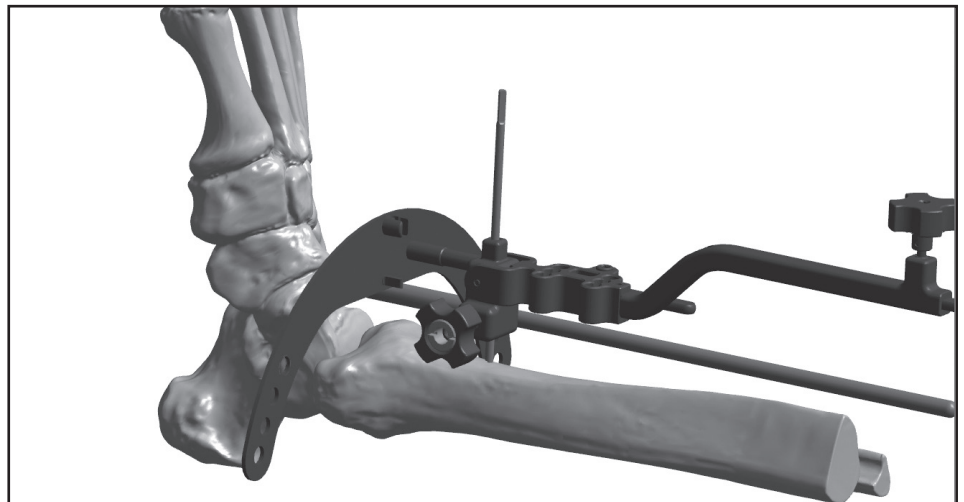

Fig. 26

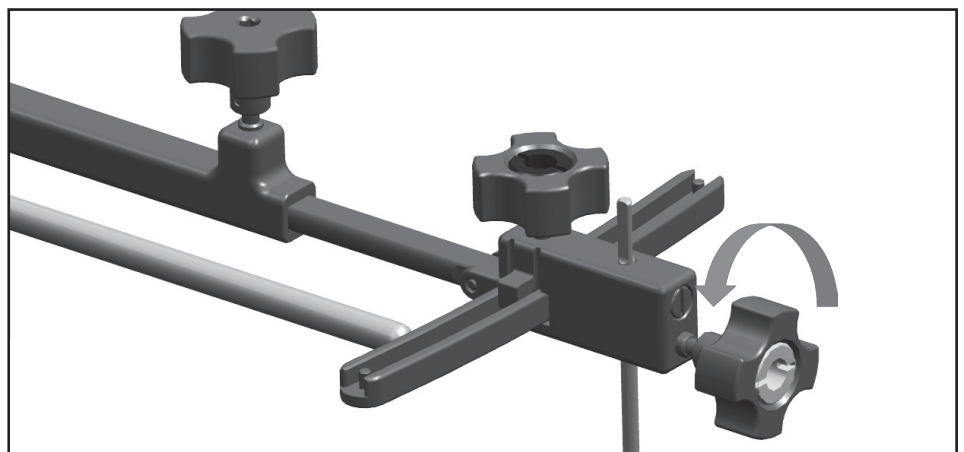

Fig. 27

Operative technique

Under lateral fluoroscopy use the position of the Alignment Rod to establish desired sagittal rotation. Typically, this is parallel to the anterior cortex of the tibial shaft (fig. 28). However, as with coronal plane alignment, study the preoperative radiographs to determine the appropriate alignment. Full length tibia radiographs, or hip/knee/ankle radiographs, may be necessary to assist in this assessment.

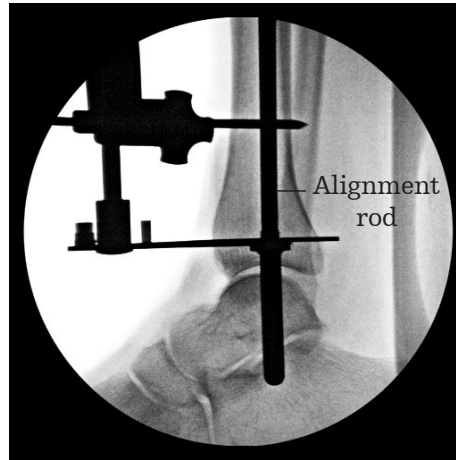

Fig. 28

After adjustments are set, use the hex driver to lock both proximal and distal (aqua-colored) adjustment knobs by securely tightening them (fig. 29).

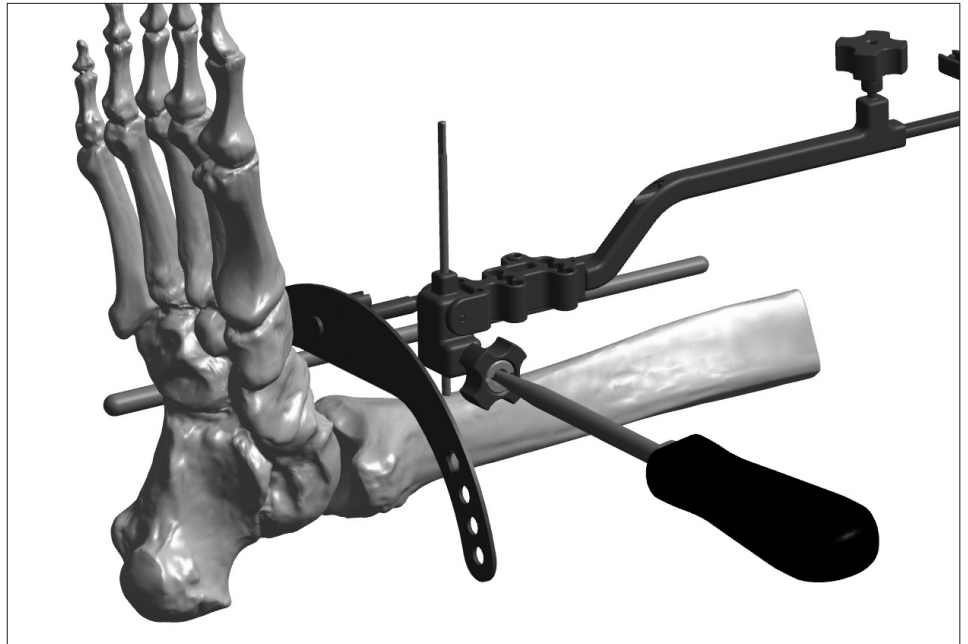

Fig. 29

Operative technique

Install sizing and resection guide adjustment block

Place two pin sleeves (33600025) into the two aligned holes that provide the optimal bone purchase. Typically (but not always) these will be the two center holes (fig. 30).

⚠ CAUTION

The two holes chosen must align with one another e.g. both center holes, both medial holes or both lateral holes.

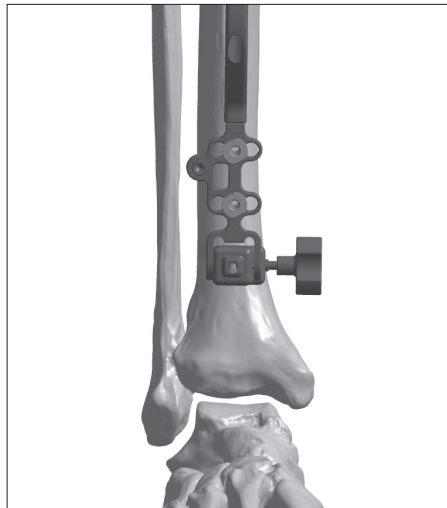

Fig. 30

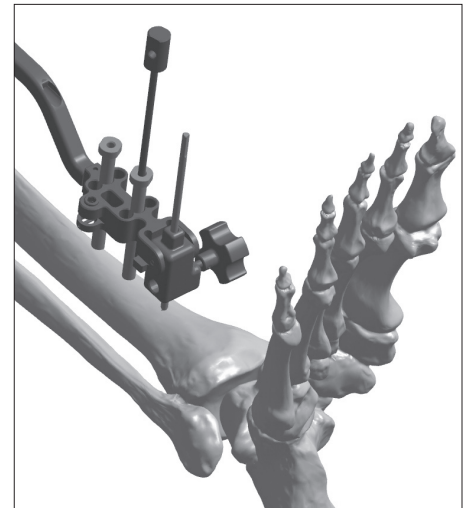

Fig. 31

Insert the trocar (33600026) through each of the pin sleeves to create entrance portals for the percutaneous pins (fig. 31).

Install a 3.2mm pin into each pin sleeve and through both cortices of the tibia (fig. 32). Remove both pin sleeves, loosen the two aqua colored knobs, and remove the alignment frame. Remove the proximal tibial pin (or knee bracket), as well as the most distal tibial pin, leaving the two parallel pins in place (fig. 33).

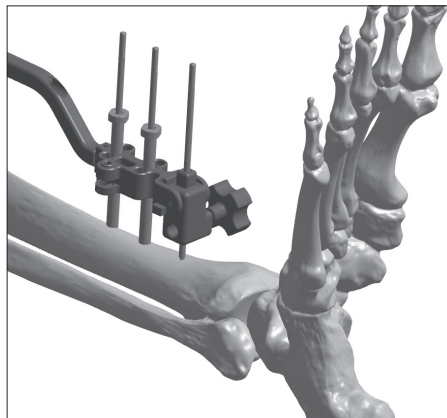

Fig. 32

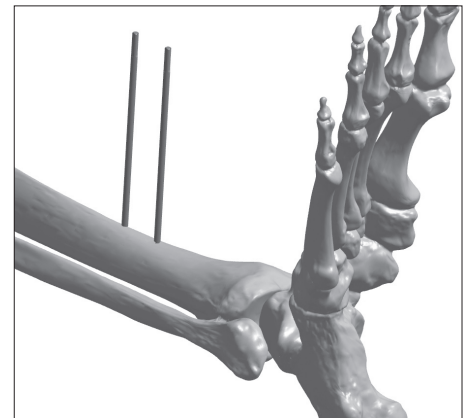

Fig. 33



Pin sleeve
33600025



Trocar
33600026

Operative technique

Coronal plane sizing and positioning

Place the adjustment block (33600030) on the two parallel tibial pins, and lock it in place a few millimeters above the surface of the tibial crest (fig. 34). It is important not to rest the block directly on the tibia as it may not freely translate into the desired position. Lock the adjustment block into this position by tightening the gray side knob with the hex driver (fig. 35).

Connect the coronal sizing guide (33620032 – 33620035) to the adjustment block by sliding it onto the dovetail opening. Allow the guide to slide into the dovetail until it rests against the surface of the tibia. Then, raise the guide to leave 1mm of clearance between the guide and the tibial plafond. Lock into place with the hex driver (fig. 36).

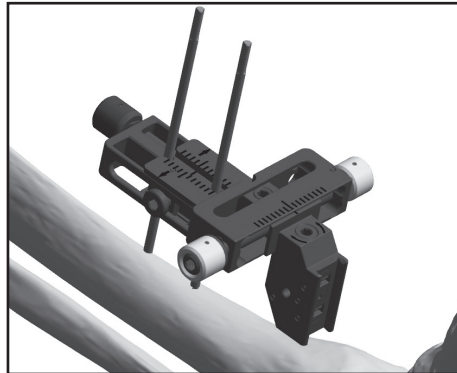

Fig. 34

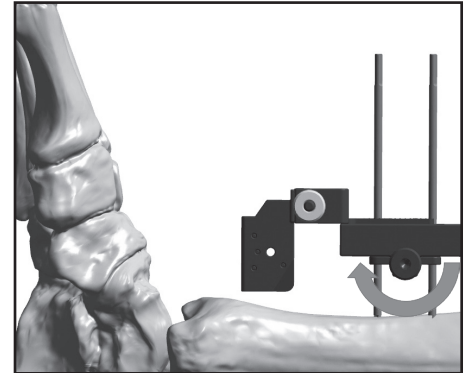

Fig. 35

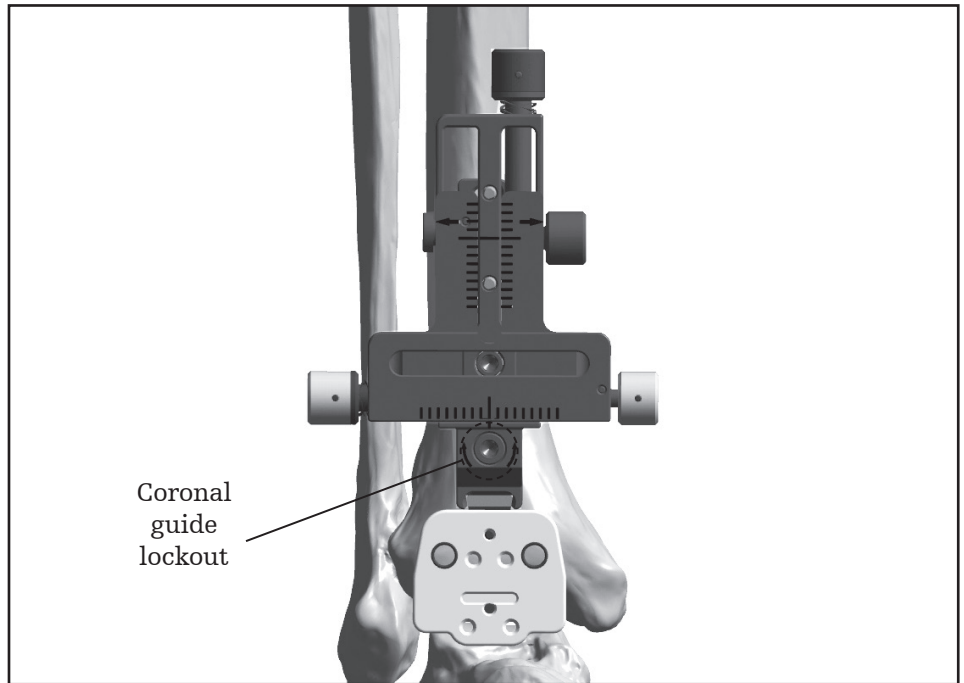

Fig. 36



Adjustment block
33600030



Coronal sizing guide
33620032 - 33620035

Operative technique

To correct for parallax, the coronal adjustment guide contains a "pin-in-circle" feature. The c-arm should be adjusted so that the pin appears in the center of the circle (fig. 37-38).

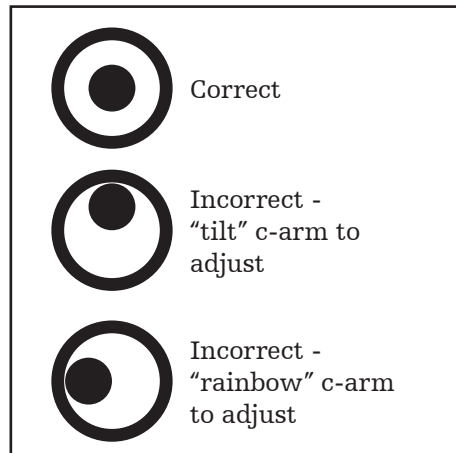

Fig. 37



Fig. 38

Operative technique

Once fluoroscopic alignment is established, use the adjustment block to translate the coronal sizing guide to the center of the joint. The purple knob will translate the guide proximal to distal and the green knobs will translate the guide medial to lateral. After adjustments are set, use the hex driver to lock both positions (fig. 39).

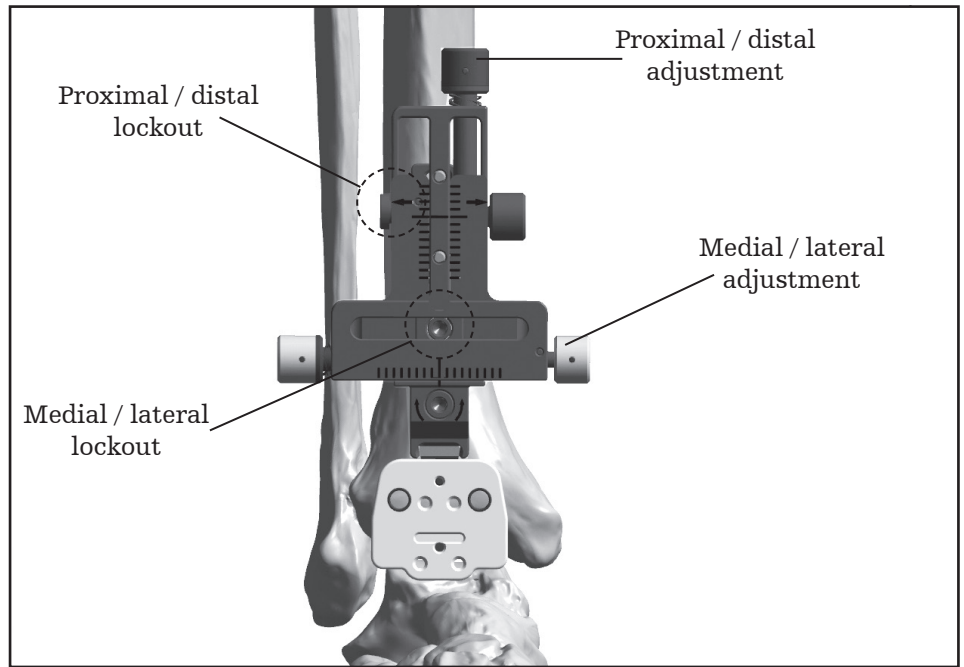
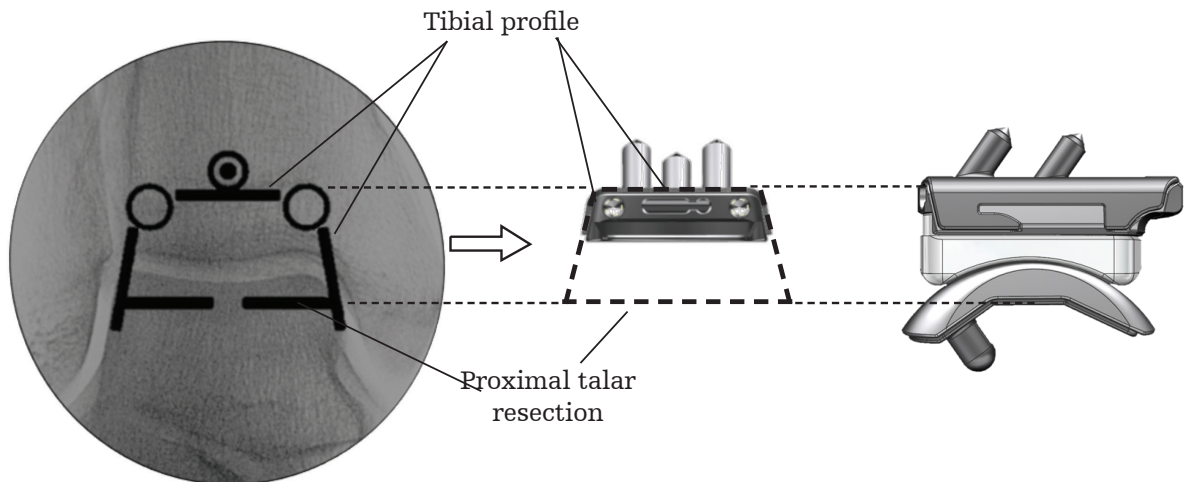

Fig. 39

The dark outlines in the coronal sizing guide represent the tibial and talar bone resections, as well as the coronal profile of the tibial component.

CAUTION
For proper evaluation, the ankle must be positioned at 90°.



Operative technique

Sagittal plane sizing and resection height

Slide the sagittal sizing ratcheting arm (33600068) onto the sagittal sizing guide arm (33600040) and install the guide arm into the coronal sizing guide. Next slide the appropriately sized sagittal sizing guide (33620042 – 33620045) onto the ratcheting arm (fig. 40). Attach the sagittal sizing guide assembly to the coronal guide by inserting the metal tab of the guide arm into the open slot of the coronal guide (fig. 41).

To minimize parallax distortion and magnification error, the sizing guide should be oriented on the side of the ankle closest to the c-arm receiver, and the sagittal sizing guide should be placed as close to the bone as possible (fig. 42). Ideally the c-arm should be situated on the same side of the bed as the ankle being replaced, in order to allow the ankle to be placed as close to the receiver as possible.

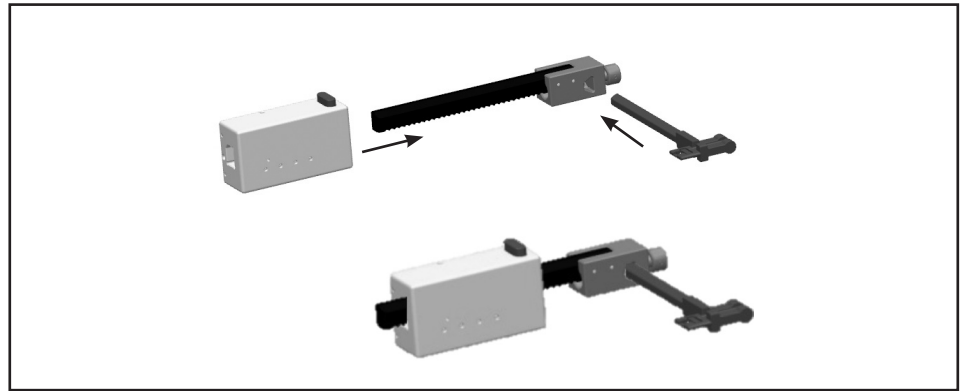

Fig. 40

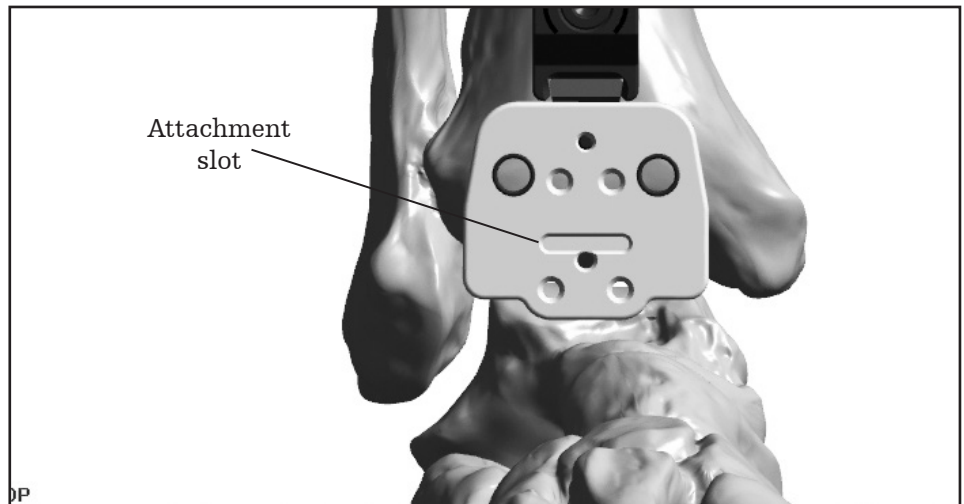

Fig. 41

Sagittal sizing ratcheting arm
33600068



Sagittal sizing guide arm
33600040



Sagittal sizing guide
33620042 - 33620045

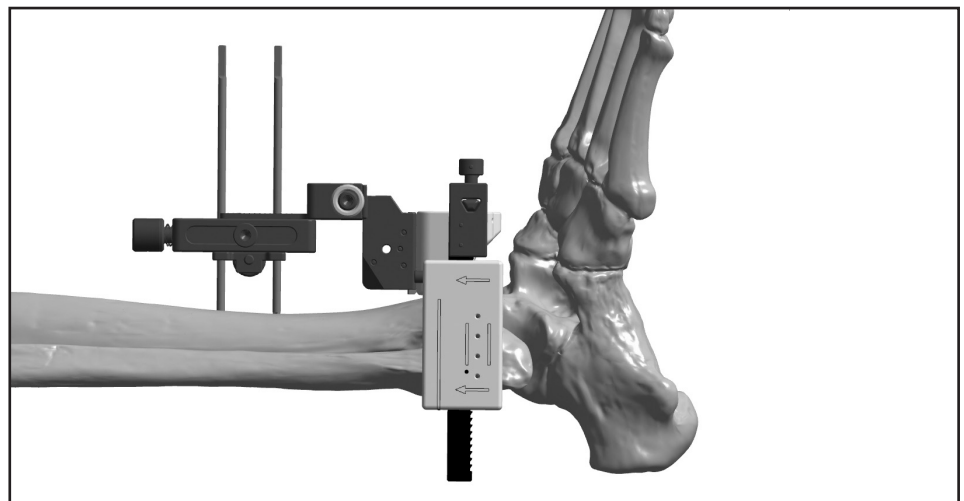

Fig. 42

Operative technique

To fluoroscopically obtain a true lateral view, ensure that the center row of talar alignment pins appear as true solid circles (fig. 43). These pins must be viewed “end on” to prevent misinterpretation of the fluoroscopic image.

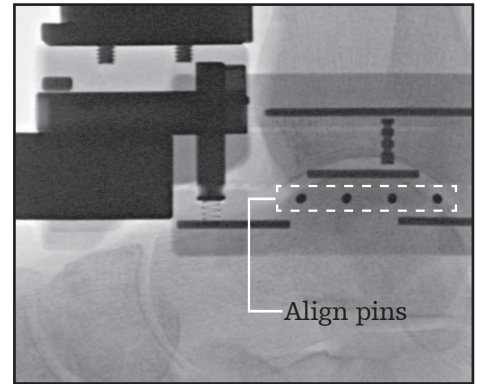

Fig. 43

Make c-arm adjustments as necessary in order to avoid parallax distortion (fig. 44 and fig. 45).

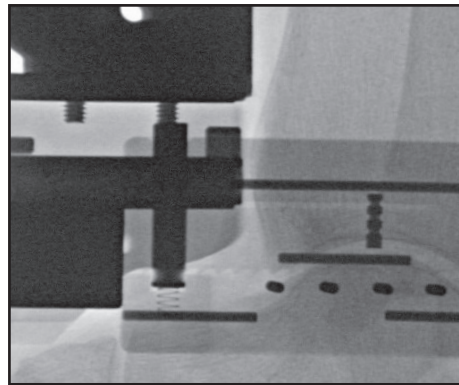

Fig. 44
Rotate or “Rainbow” c-arm to adjust

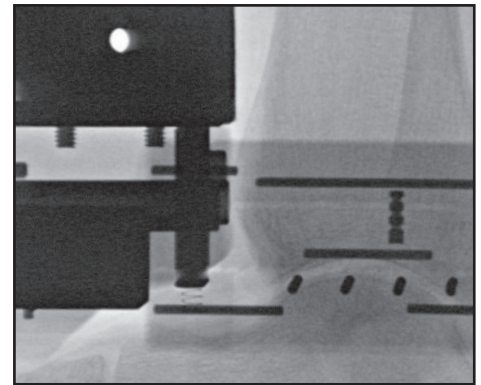

Fig. 45
Swing or “Wig-Wag” c-arm to adjust

As an additional fluoroscopic check a 2.4 Steinmann pin can be placed through the center hole of the coronal alignment guide (fig. 46). In a lateral plane fluoroscopic image this pin will indicate the height of the proximal talar resection and in a true lateral view should be inline with the row of alignment pins in the sagittal guide (fig. 47).

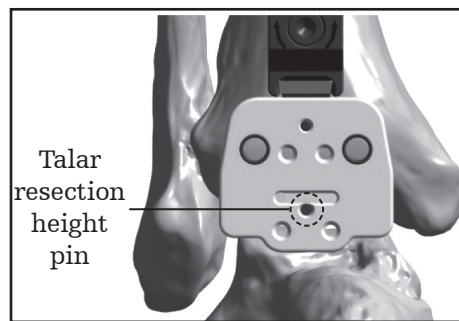

Fig. 46

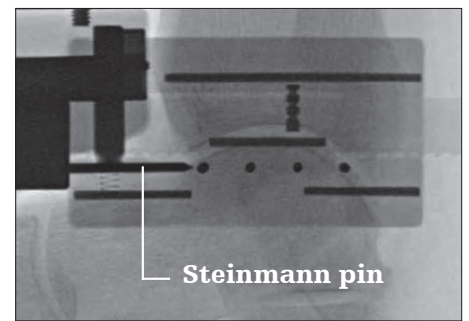

Fig. 47

Operative technique

The sagittal sizing guide is used to fluoroscopically set the proximal extent of the tibial resection, and distal extent of the talar resection. The sizing guide contains fluoroscopic indicators that correspond to the tibial resection, joint line (top of the talar dome), height of the proximal talar resection, and the distal extent of the anterior chamfer. The sizing guide also has an indicator for the anterior to posterior dimension of the tibial implant.

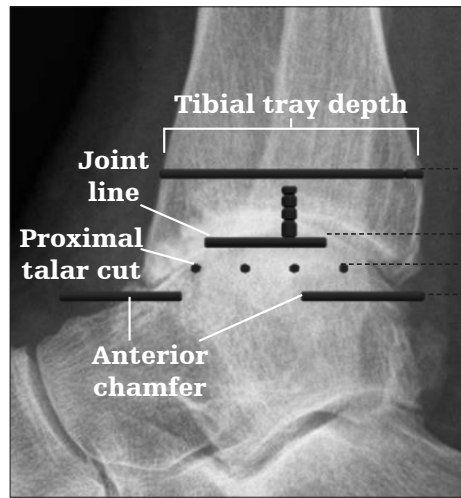

Fig. 48



Fig. 49

Turn the purple knob of the adjustment block to achieve the desired resection height. Position the guide so the proximal edge of the “joint line” pin aligns to the proximal extent of the talar bone or the desired location of the reconstructed joint line (fig. 48-49).

CAUTION

For proper evaluation the ankle must be positioned at 90°.

Study the talus carefully, and if it is not in the 90° position due to posterior contracture, the surgeon should lengthen the achilles tendon and remove anterior impinging osteophytes.

Multiple component sizes can be evaluated by replacing both corresponding coronal and sagittal sizing guides.

Operative technique

NOTICE

Note that the distal extent of the anterior chamfer also corresponds to the flat cut surface of an infinity with adaptis technology flat cut talar dome (fig. 50-51).

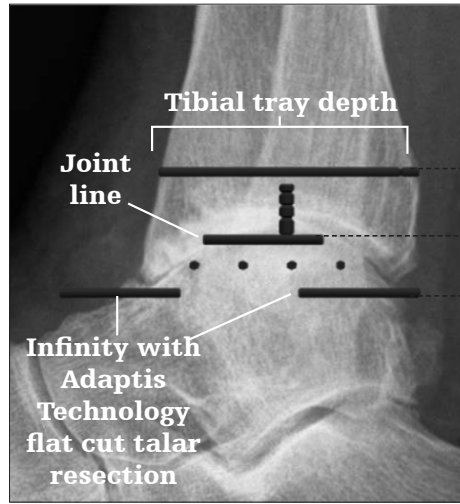

Fig. 50



Fig. 51

The sagittal sizing guide also has a proximal/distal tibial resection depth indicator for evaluating the amount of tibial resection. In addition, there is a notch in the tibia tray A/P length marker that allows the surgeon to evaluate whether a standard or long sized tibial tray may be required (fig. 52).

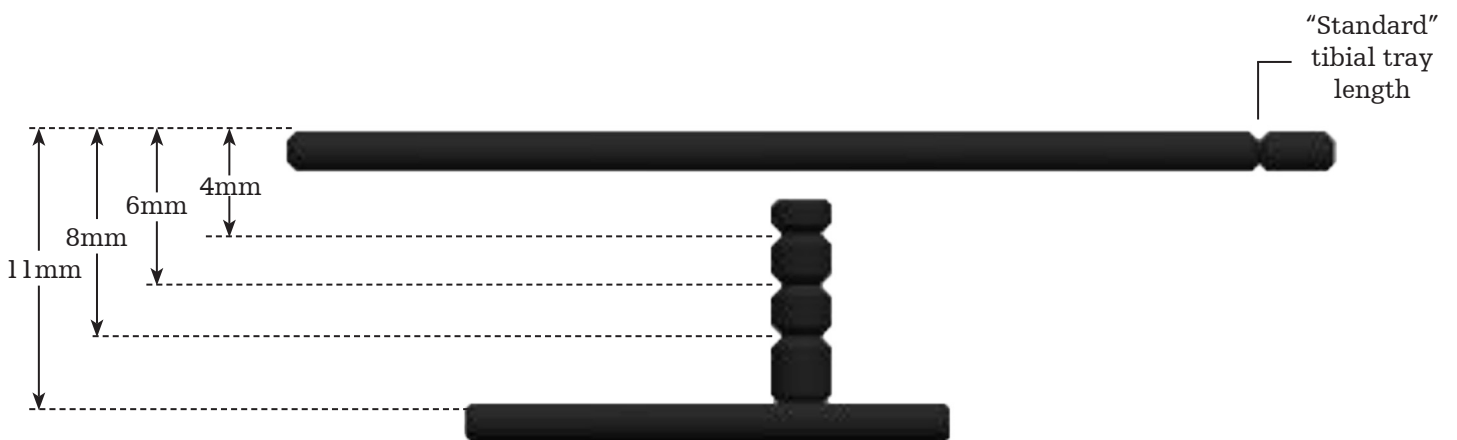

Fig. 52

Operative technique

Drill tibial corners

For steps on how to utilize an Infinity with Adaptis Technology flat cut talar dome instead of the standard chamfer-cut infinity with adaptis technology talar dome refer to Appendix A.

If any translational adjustments were made it is recommended to take a final AP fluoroscopic image to confirm coronal positioning.

Ensure that all adjustment block positions are secured with the hex driver and place four 2.4mm steinmann pins (200072) into the coronal sizing guide (fig. 53) Place the two tibial pins first then place the talar pins.

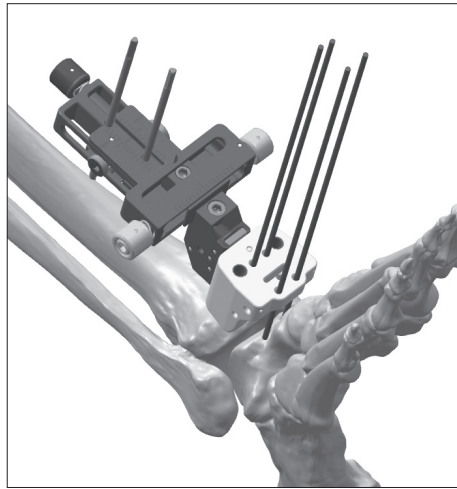

Fig. 53

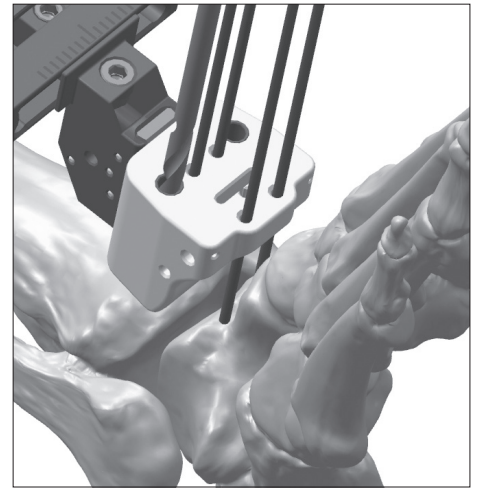

Fig. 54

⚠ CAUTION

During installation of the distal talar pins it is critical that the ankle be positioned at 90°.

Using the tibial corner drill (33600048), bi-cortically drill both proximal corners of the tibia (fig. 54).



Tibial corner drill
33600048

Operative technique

Bone Resection

Remove the coronal sizing guide and slide the appropriately sized resection guide (33620052 – 33620055) over the 2.4mm pins and into the adjustment block (fig. 55). Secure with hex driver.

Install a 2.4mm steinmann pin into each gutter location. Using the pin cutter trim the pins flush to the surface of the resection guide (fig. 56).

Optionally, for additional stability, install a 2.4mm pin through one of the two divergent pin locations (fig. 56). When using a divergent pin always use the medial option (in which the pin travels medial to lateral). This will help avoid the neurovascular bundle posterior to the medial malleolus. Cut the pin leaving enough length to allow its later removal with a pin driver or pin puller but short enough to allow saw blade clearance in the medial resection slot (approximately 15mm).

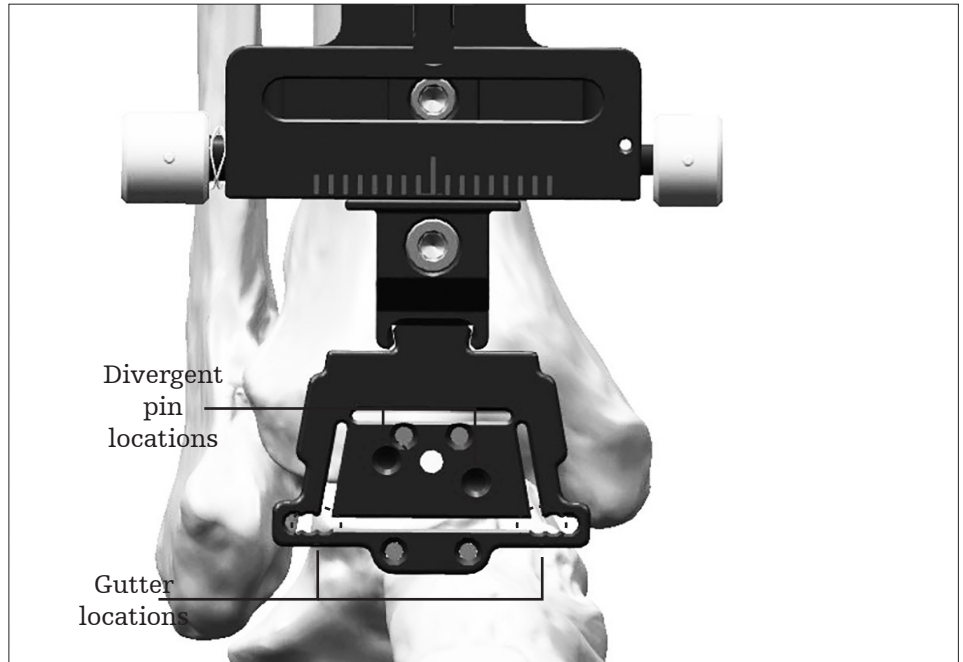

Fig. 55

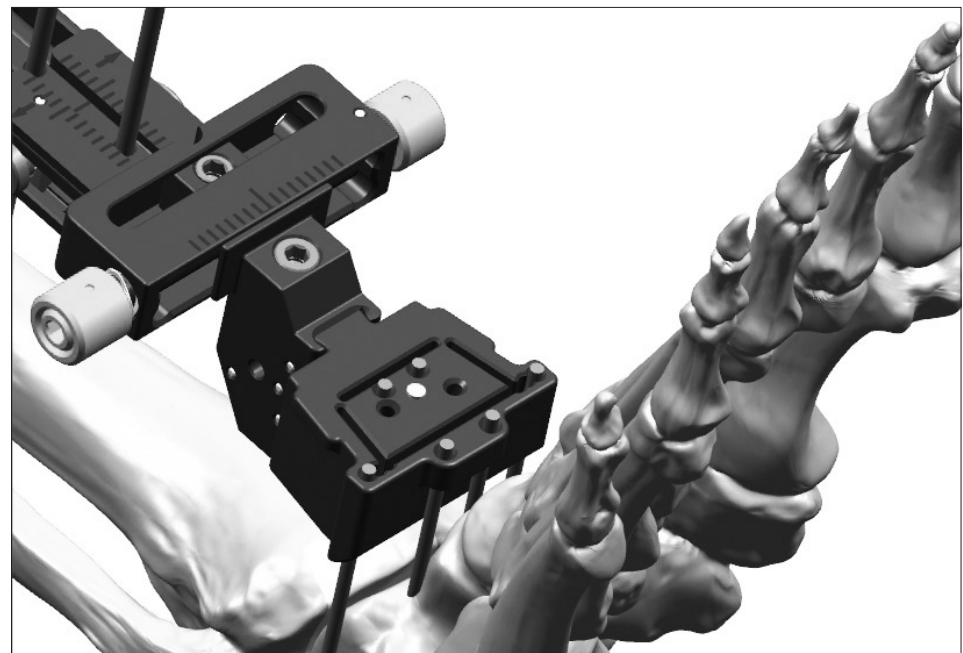
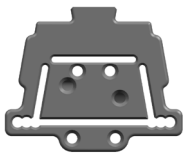

Fig. 56



Resection guide
33620052 – 33620055



Pin cutters
200427

Operative technique

Using the appropriately sized saw blade and oscillating bone saw make the tibial and talar bone resections. This includes cutting through the proximal, distal, medial and lateral slots of the resection guide.

Remove the divergent steinmann pin then remove the resection guide, adjustment block and remaining steinmann pins. Check that the talar resection is complete by using a 1/2 inch osteotome. Complete the cut if necessary and gently lever the resected bone out anteriorly.

Optionally, to facilitate removal of the remaining posterior tibia, the corner chisel (33600058) and a mallet can be used to finish off bone cuts in the proximal corners of the resected tibia (fig. 57). The corner chisel is laser marked to indicate the anterior to posterior depth of the various size tibial trays.

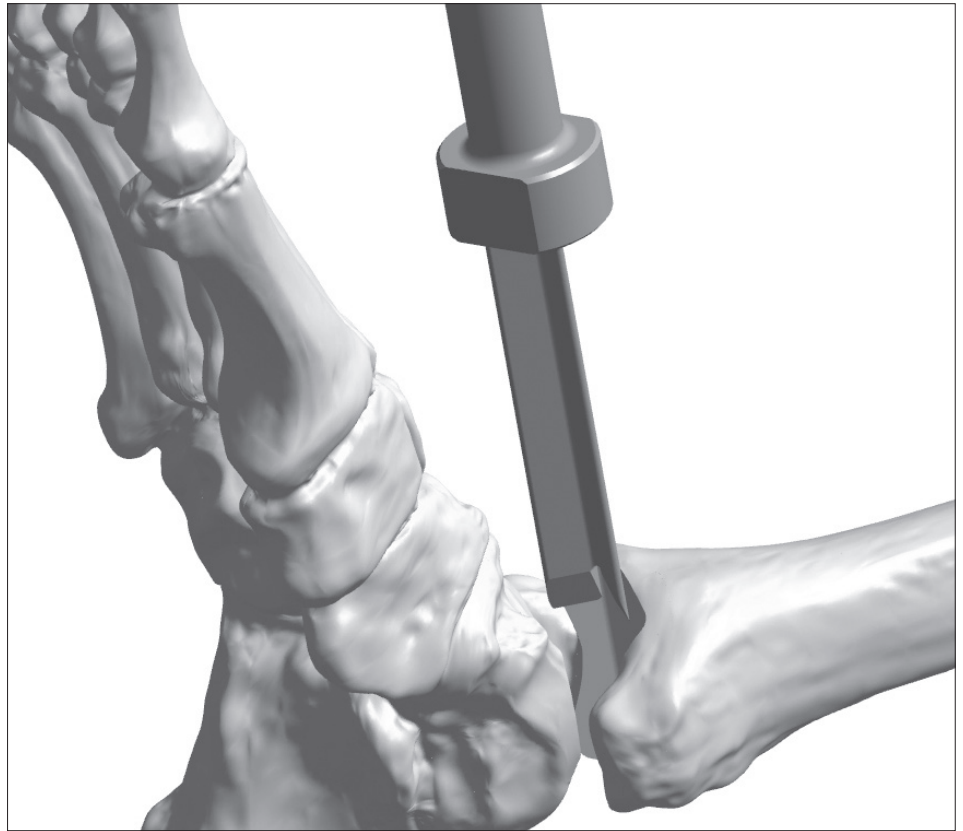

Fig. 57

CAUTION

Care must be taken to ensure that the corner chisel does not penetrate too deeply, as neurovascular injury may occur. Do not rely solely on the depth indications on the chisel to determine resection depth. If unsure, utilize a lateral fluoroscopic image to confirm proper depth of the chisel.



Corner chisel
33600058

Operative technique

Remove tibial bone resection

Using a pin driver, insert the bone removal screw (IB200051) into the resected tibial bone. Attach the ratcheting handle (44180025) to the bone removal screw to aid in removing the remaining tibial section through traction (fig. 58).

Insert the 90° posterior capsule release tool (IB200050) into the joint space and use to free up the posterior capsule soft tissues attachments to the resected tibia (fig. 59-60).



Fig. 58

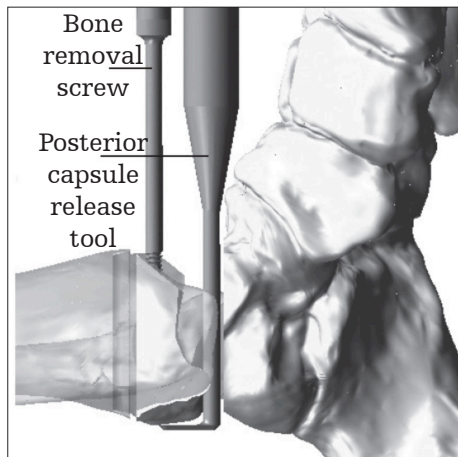

Fig. 59

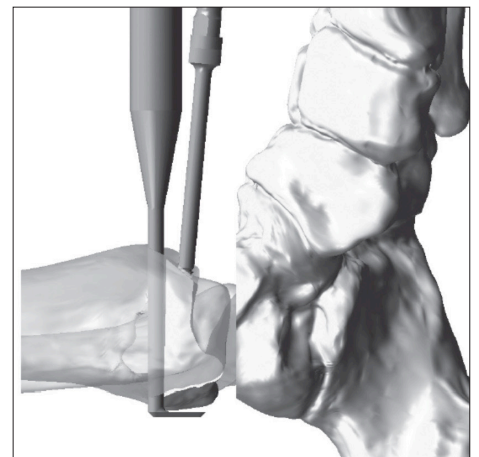

Fig. 60



Operative technique

Tibial tray trialing and AP sizing

Remove tibial bone resection. A reciprocating saw or bone rasp may be used to remove any excess bone, taking care to follow the previously made cut line. Remove loose bone pieces and irrigate the joint space (fig. 61).

Place the appropriately sized tibial tray trial (33620062 - 33620065) into the resected joint space and seat flush against the resected tibia. Padded self-retaining laminar spreaders (33609012) can be inserted between the trial and the talus to ensure the trial is seated flush (fig. 62). Also ensure the tibial trial is fully seated against the anterior cortex of the tibia (fig. 63) And secure in place using two 2.4mm steinmann pins (fig. 64).

The tibial tray trial is also used to check the tibial cut surfaces and ensure that no bone fragments will impede proper positioning of the tibial tray. Remove excess bone and irrigate as necessary.

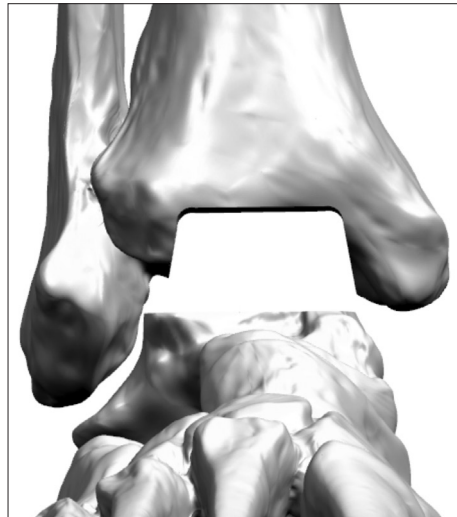

Fig. 61



Fig. 62

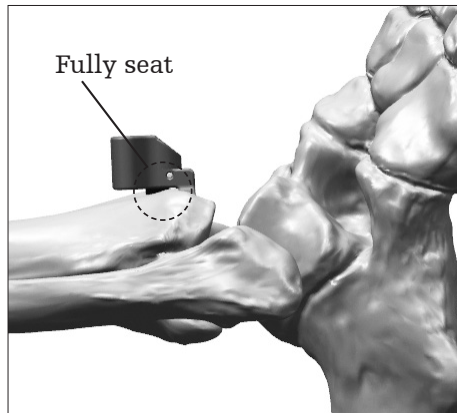

Fig. 63



Fig. 64



Tibial tray trial
33620062 - 33620065



Self-retaining laminar spreaders
33609012

Operative technique

The tibial trial allows the surgeon to determine both the optimal AP tibial coverage and positioning through fluoroscopic evaluation (fig. 65).

For sizes 3 through 5 the surgeon has the option to choose either a standard or long AP sized tibial tray. The notch in the tibial trial indicates the length of the “standard” option (fig. 66).

Tibia component sizes 1 and 2 are each available in only one AP length. Because they share the same ML dimension, they utilize the same tibial trial. When using the size 1&2 tibia trial the full length represents the size 2 and the notch indicates the length of the size 1 option.

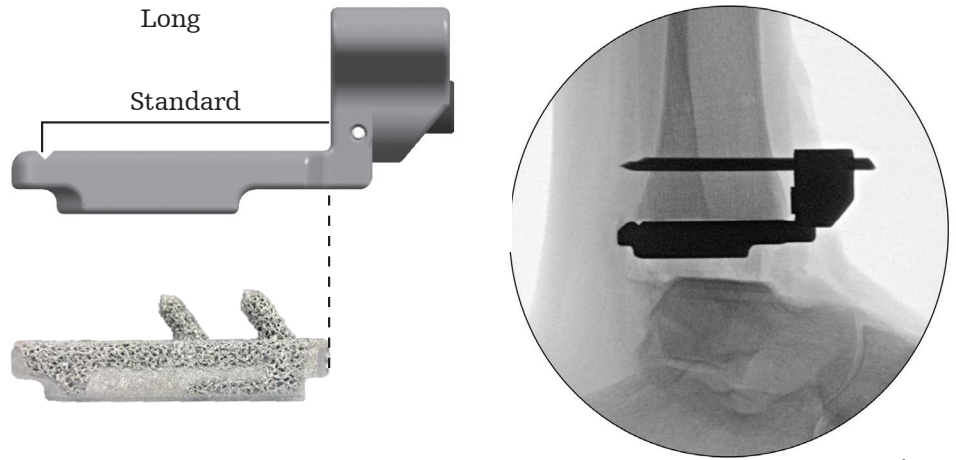

Fig. 65

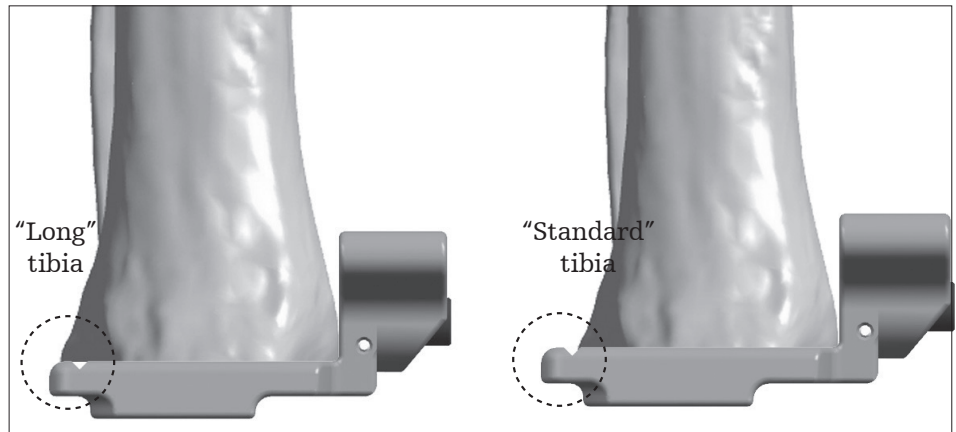

Fig. 66

Operative technique

The surgeon also has the option to anteriorly translate the tibial trial (maximum of 3mm) in order to minimize posterior overhang if desired (fig. 67). To adjust, insert the hex driver into the front of the tibial trial and turn clockwise. (fig. 68-69).

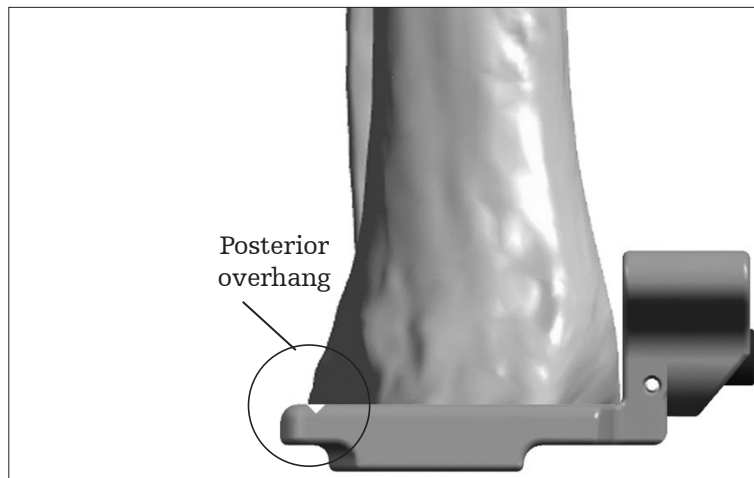

Fig. 67

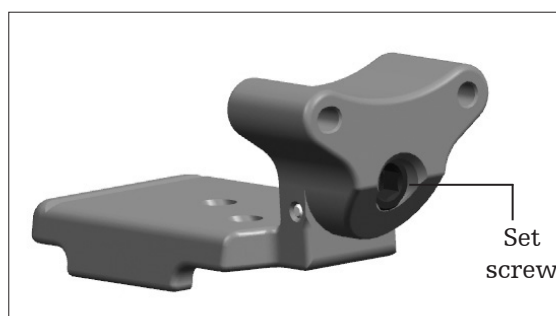

Fig. 68

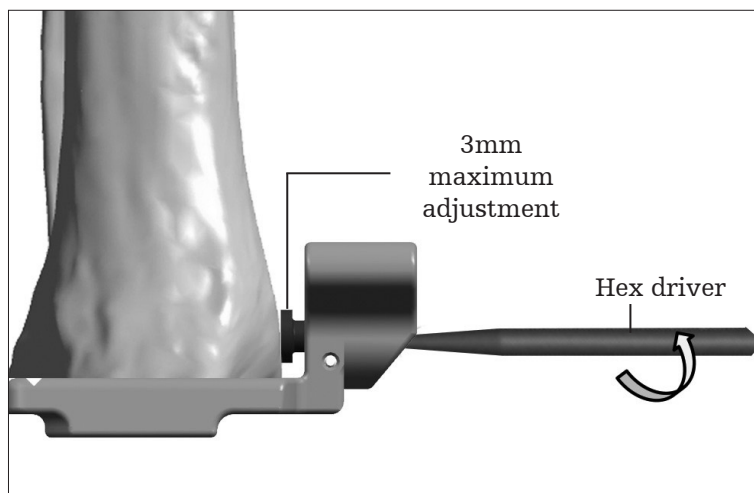

Fig. 69

Operative technique

Tibial peg broaching

Cut the steinmann pins to the surface of the tibial tray trial. Using the posterior tibial peg broach (33600069), prepare a hole in the resected tibia by malleting the broach through the posterior opening of the trial (fig. 70). Temporarily leave the posterior broach in place while the two anterior holes are prepared.

Using the anterior tibial peg broach (33600067), prepare the two anterior holes through the trial (fig. 71).

After all three holes are prepared, remove both broaches and leave the tibial tray trial in place (fig. 72).



Fig. 70



Fig. 71

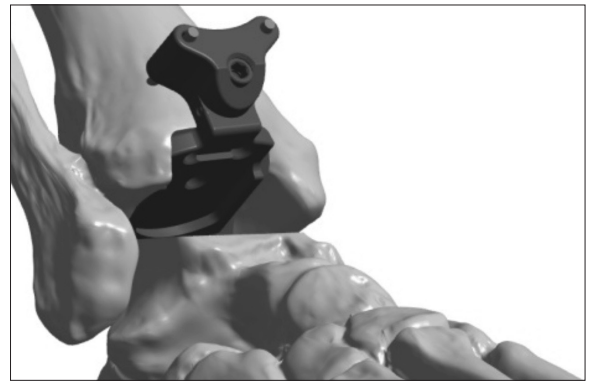

Fig. 72



Posterior tibial peg broach
33600069



Anterior tibial peg broach
33600067

Operative technique

Talar component sizing and positioning

Place the appropriately sized talar dome trial (33600071 – 33600075) into the joint space. Using the poly insert trial Holding tool (IB200110), install the appropriately sized poly insert trial (33621106 – 33625512) into the tibial tray trial. The locking tab of the poly insert trial should engage the tibial tray trial (fig. 73).

The surgeon has two options for the talar dome implant size at this juncture: either the matching size for the implanted tibial tray, or one size smaller. It is beneficial to assess both sizes under A/P and lateral fluoroscopic images.

Please note that the A/P image is critical for sizing the talar component, as the surgeon's goal is to minimize overhang of the talar component, and thus minimize prosthetic impingement in the medial and lateral gutters of the ankle joint.

For steps on how to make a 2mm talar re-cut refer to Appendix B.

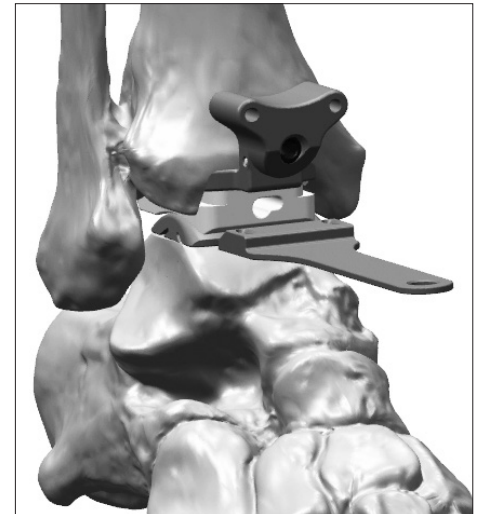

Fig. 73



Poly insert trial holding tool
IB200110



Talar dome trial
33600071 - 33600075

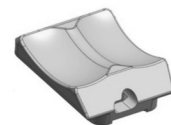

Poly insert trial
33621106 - 33625512

Operative technique

Under sagittal plane fluoroscopy, ensure the posterior portion of the Talar Trial is resting on the posterior portion of the patient's residual talus (establish congruence) (fig. 74-75).

To accurately perform the range of motion, place some axial compression on the components to maintain position, and flex and extend the ankle. The surgeon will observe the talar component rotating into the anatomic position for this particular patient, establishing the center of rotation for the ankle. Note that the surgeon must not only be cognizant of the talar position in the sagittal plane, but must simultaneously maintain medial/lateral coverage as evidenced by the previous A/P plane fluoroscopic views.

Once the talar dome trial has settled into optimum anatomical position, hold the foot in place and install two 2.4mm steinmann pins through the talar dome trial to temporarily hold it in place (fig. 76).

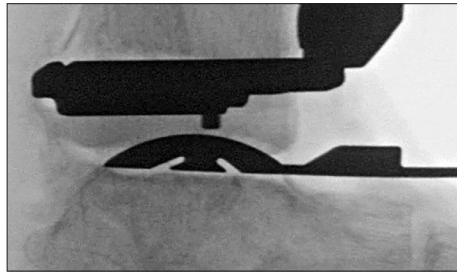

Fig. 74

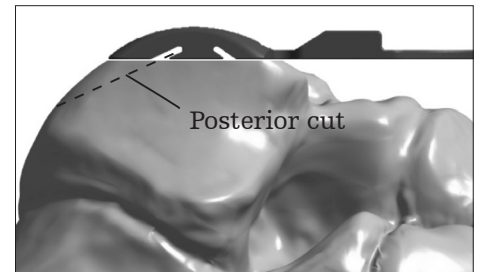

Fig. 75

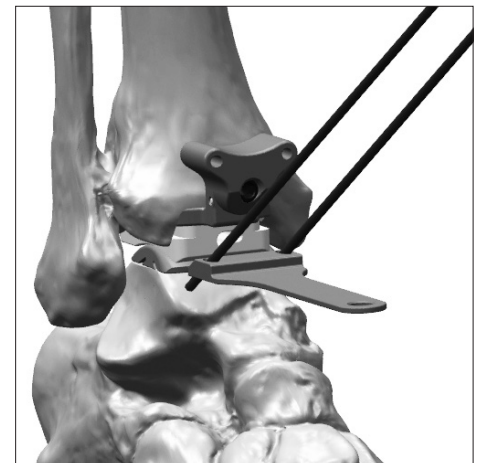

Fig. 76

Operative technique

Talar chamfer resections

Using the poly insert trial holding tool, remove the poly insert trial. Slide the talar dome trial off the 2.4mm pins in the talus and slide the tibial tray trial off the 2.4mm pins in the tibia (fig. 77). The two 2.4mm tibial pins may now be removed as well.

Slide the talar resection guide base (33600091 – 33600095) onto the two 2.4mm pins in the talus and seat flush to the resected talar surface (fig. 78).

Using the T-handle pin driver (33600120), or power drill install two temporary fixation screws (33610002 or 33610003) through the talar resection guide base into the talus (fig. 79).

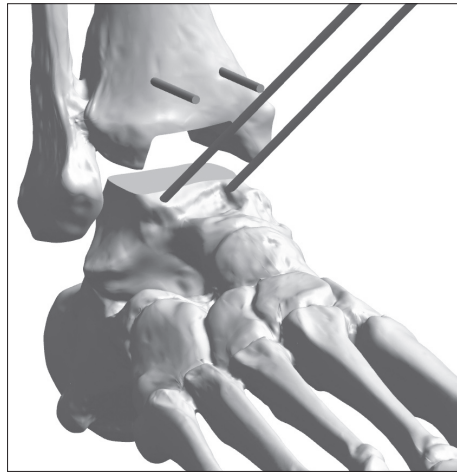

Fig. 77

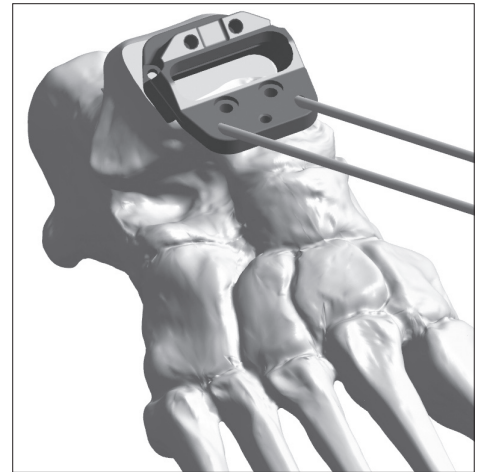

Fig. 78

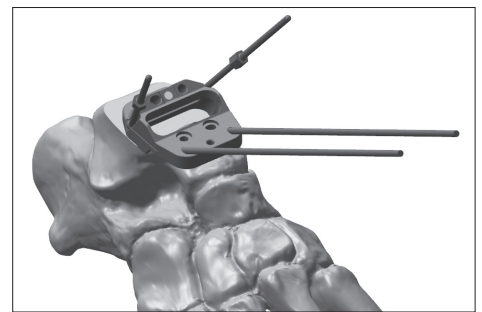

Fig. 79



Talar resection guide base
33600091 - 33600095



T-handle pin driver
33600120



Temporary fixation screw
Long - 33610002
Short - 33610003

CAUTION

When installing the temporary fixations screws, care must be taken to avoid over torquing. It is recommended to install the screws to 3/4 of their entire depth under power, finishing with the T-handle, to avoid inadvertent breakage.

Operative technique

Using the appropriately sized saw blade and oscillating or reciprocating bone saw, make the posterior talar chamfer resection through the slot in the talar resection guide base (fig. 80).

Remove the two anterior 2.4mm pins. One of these pins can then be installed through the anterior pin hole in the guide base to provide additional fixation during the talar preparation steps. Cut this pin flush to the surface of the guide base to prevent interference with the saw blades and reamers (fig. 81).

CAUTION

Careful attention should be paid to not allow the saw blade to skive due to bone curvature or sclerotic bone posteriorly. A clean-up pass with the saw will help ensure the bone is adequately resected.

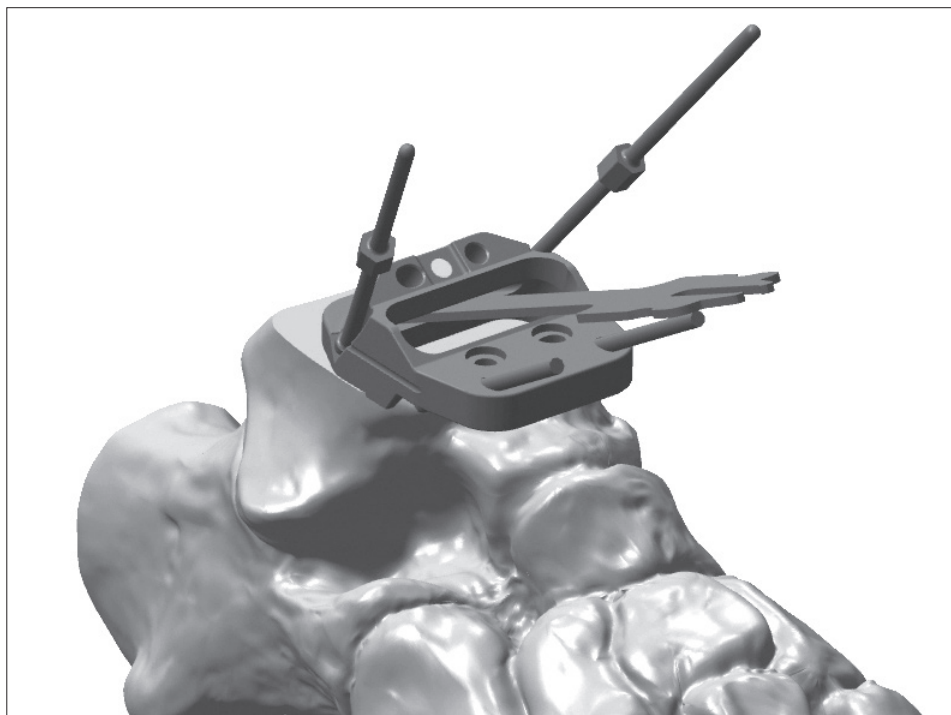

Fig. 80



Fig. 81

Operative technique

Assemble the anterior talar pilot guide (33600101 – 33600105) with pegs facing down onto the anterior face of the talar resection guide base (fig. 82).

Use the appropriately sized talar reamer (33600123 or 33600126) to plunge cut through all four holes of the pilot guide (fig. 80). This will prepare the talar surface for the anterior flat of the talar component.

Remove the pilot guide and replace with the anterior talar finish guide (33600111 – 33600115) (fig. 84).

Use the talar reamer to perform the finishing cuts for the anterior talar flat by sliding the reamer from side to side within the finish guide (fig. 85). To ensure bone cuts are at the proper depth, make sure the shoulder of the reamer is flush against the guide for each reaming step.

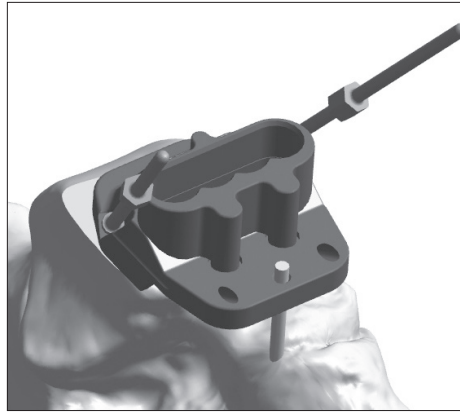

Fig 82

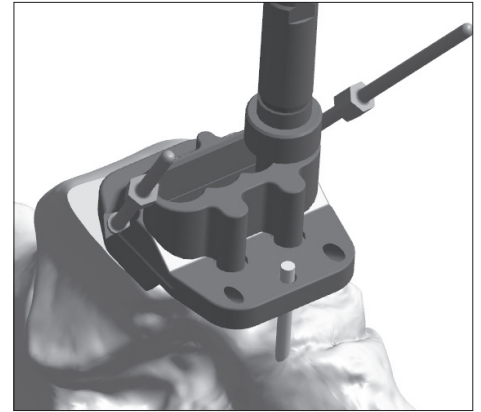

Fig 83

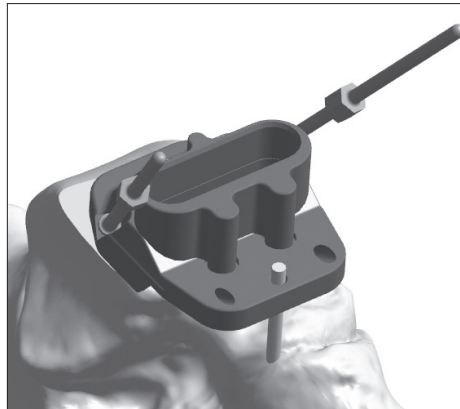

Fig 84

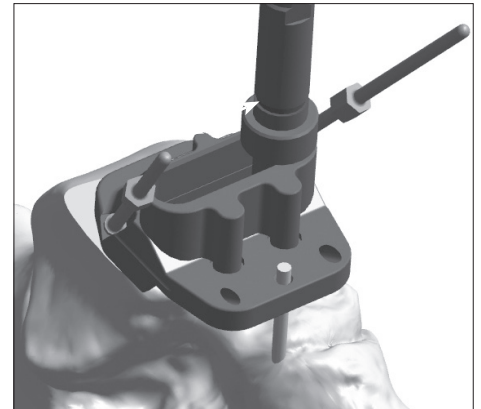

Fig 85

CAUTION
Take care not to rock or dislodge the pilot/finishing guide and guide base during reaming.



Anterior talar pilot guide
33600101 - 33600105



Talar reamer
Size 1-3 - 33600123
Size 4-5 - 33600126



Anterior talar finish guide
33600111 - 33600115

Operative technique

Remove the finish guide and reassemble the pilot guide onto the talar resection guide base. The pilot guide will now be rotated 180° from the previous steps (fig. 86).

Again use the talar reamer to plunge cut through all four holes of the pilot guide (fig. 87). This will prepare the talar surface for the anterior chamfer of the talar component.

Remove the pilot guide and assemble the finish guide to complete the preparation of the anterior chamfer (fig. 88).

Using the talar reamer, perform the finishing cuts for the anterior talar chamfer by sliding the reamer from side to side within the finish guide (fig. 89).

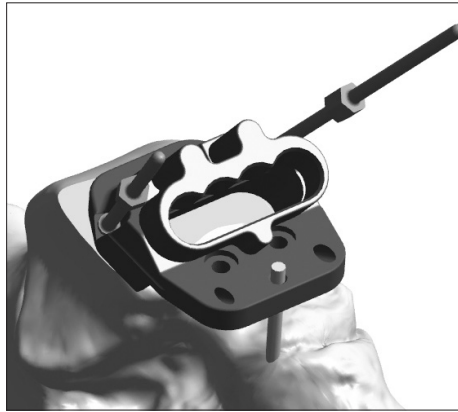

Fig. 86



Fig. 87



Fig. 88



Fig. 89

Operative technique

Remove the fixation pins and resection guide base and remove any residual bone medial and lateral to the prepared chamfer cuts using either an osteotome or rongeur (fig. 90).

NOTICE

Due to the angle of the cut, it may be necessary to finish the posterior chamfer with a reciprocating saw following removal of the talar resection guide base. Careful attention must be paid to ensure the full posterior chamfer was made. In cases where sclerotic bone caused the saw blade to skive and undercut, a manual “feathering” recut should be performed.

CAUTION

Failure to adequately remove residual bone from resected edges may lead to improper seating of the talar component.

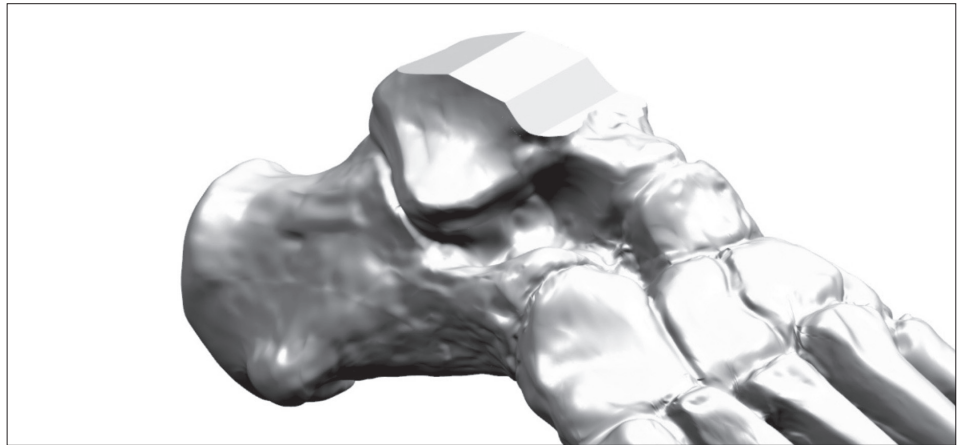

Fig. 90

Polyethylene thickness

While the final polyethylene thickness does not have to be definitively chosen during the trial phase, it is important to have what is perceived to be the appropriately sized trial poly to accurately determine the placement of the talar component. The trial poly used for the reduction should fit appropriately to determine the center of rotation of the talar component; therefore, trialing multiple size polys may be necessary. Note that after insertion of the final talar dome, the height of the poly can and should be reassessed.

In order to determine proper polyethylene height the following factors must be considered:

- Smooth range of motion of the ankle without anterior or posterior impingement.
- Ligaments are tensioned both medially and laterally without over-tensioning. Over-tensioning is noted when the trial talar component tilts following trial poly insertion. Alternatively, with range of motion, the talar component becomes incongruent with the trial poly, which can identify too much tension on the ankle replacement. Over-tensioned joints may cause increased polyethylene wear, and should be avoided.
- Stress the ankle joint into varus and valgus. The trial components should not tilt.
- The trial poly should engage the sulcus in the talar dome trial without allowing medial/lateral translation.

Operative technique

Talar peg drilling

Replace the tibial tray trial over the 2.4mm pins in the tibia. Insert the appropriately sized talar peg drill guide (33600161 – 33600165) into the joint space and over the resected talus. Reinstall the poly insert trial into the tibial tray trial and perform a trial reduction to establish optimal talar medial/lateral positioning (fig. 91).

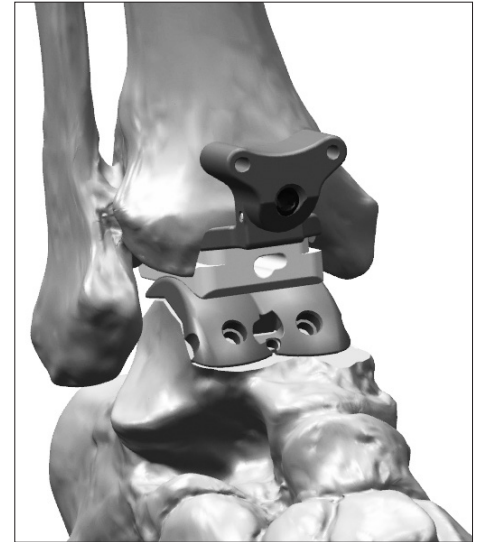

Fig. 91

Slightly plantarflex the foot and install a 2.4mm steinmann pin through the talar peg drill guide to temporarily hold it in position (fig. 92).



Fig. 92

Using the 4mm anterior peg drill (IB200020), drill a hole through the medial and lateral openings in the talar dome trial. The drill has a hard stop designed to set the appropriate drilling depth in the talus for the talar dome anterior pegs (fig. 93).



Fig. 93



Talar peg drill guide
33600161 - 33600165



Anterior peg drill
IB200020

Operative technique

Tibial component implantation

Remove the 2.4mm pins in the talus and tibia and remove the talar peg drill guide, poly insert trial, and tibial tray trial from the joint space (fig. 94).

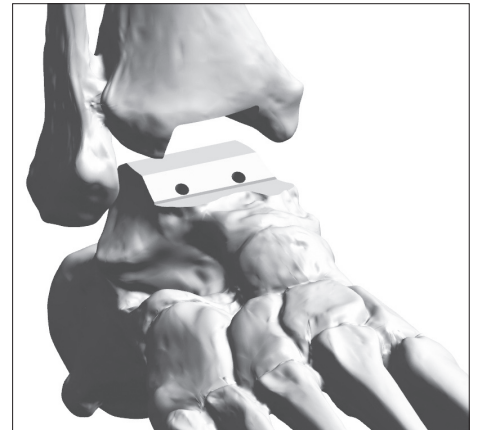

Fig. 94

Choose the appropriately sized tibial tray impaction insert (33620132 – 33620135) and assemble the tibial tray component by sliding over the dovetail opening and threading the two screws into the threaded holes in the anterior face of the tibial tray (fig. 95).

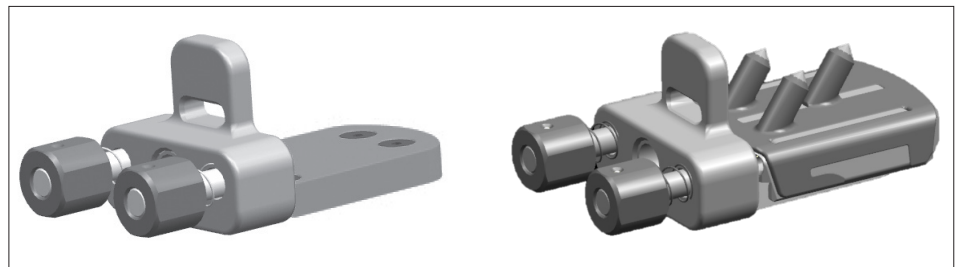

Fig. 95

Please note that older versions of tibial tray impaction inserts do not have the threaded attachments to the tibial tray component, but rather a small locking tab to provisionally hold it in place.

If choosing to cement, apply bone cement to the top and side walls of the tibial tray component, taking care not to get any cement on the anterior face or bottom of the tray.



Tibial tray
impaction insert
33620132 - 33620135

Operative technique

Thread the insertion handle (33600130) into the front of the tibial tray impaction insert and begin insertion of the tibial tray component. Introduce the tibial tray into the joint space, ensuring all three pegs of the component are aligned with the prepared holes in the tibia (fig. 96-97).



Insertion handle
33600130

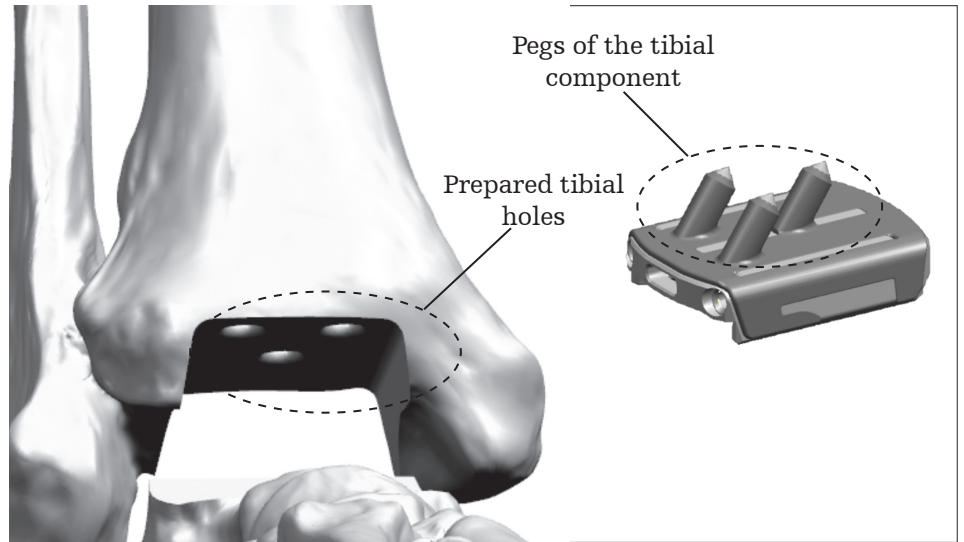

Fig. 96

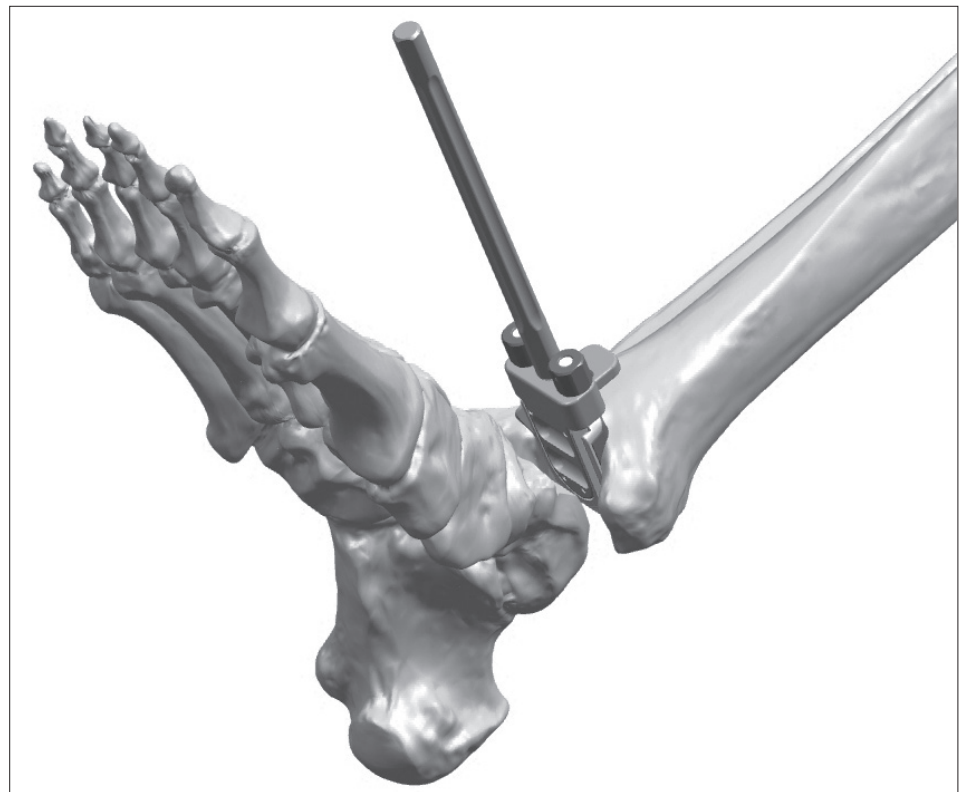

Fig. 97

Operative technique

Assemble the appropriately sized impactor arm (33680142 or 33680144) and impactor positioner (33680145) onto the offset impactor handle (33680140) (fig. 98-99).

Insert the notch of the tibial tray impactor arm into the notch of the tibial tray impactor insert and ensure the ledge of the tibial tray impactor arm is flush with the tibial tray impactor insert to secure impaction trajectory (fig. 100).

Impact the tibial tray into the prepared tibia and verify progress via fluoroscopic imaging. A straight impactor (33680141) and/or universal impactor arm (33680143) is available for final impaction if needed.

Once the tibial tray is seated, unassemble the tibial tray impact insert from the tibial tray.

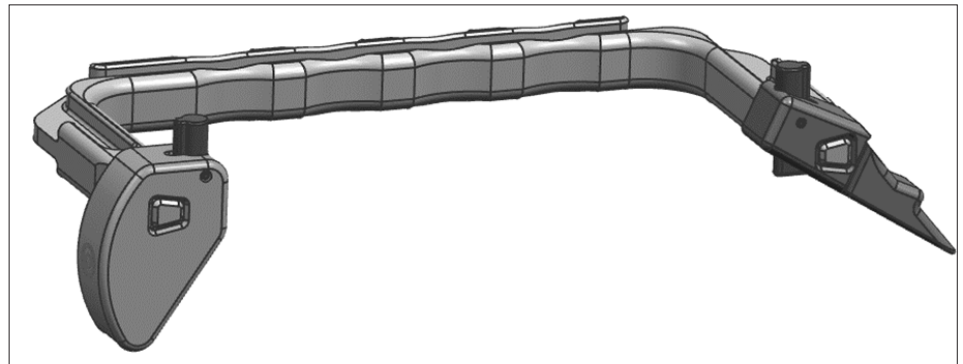

Fig. 98
Tibial tray impactor arm, positioner, and handle assembly (right hand dominant)

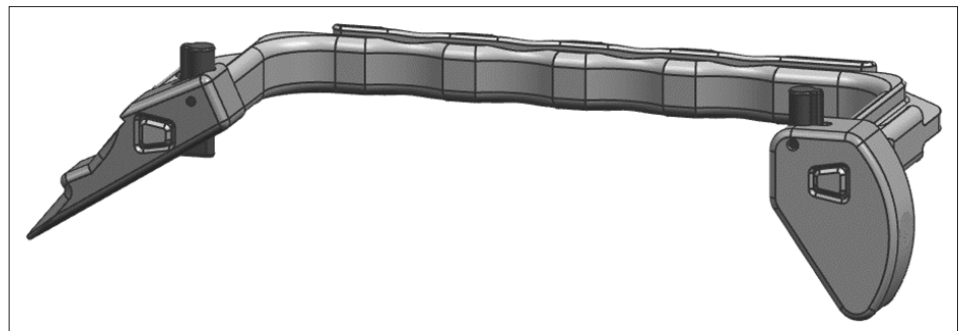

Fig. 99
Tibial tray impactor arm, positioner, and handle assembly (left hand dominant)

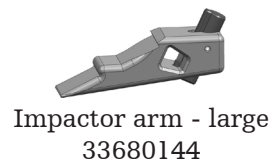
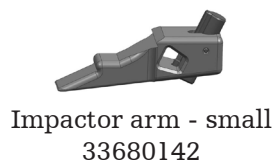

Fig. 100
Tibial tray impaction

Operative technique

Talar component implantation

Insert the appropriately sized tibial tray protector (33620152 – 33620155) into the tibial tray to protect the talar dome surface during installation (fig. 101).

If choosing to cement, apply bone cement to the bottom surface of the talar dome.

Assemble the lipped talar dome strike tip sulc (33680131) to the talar dome strike handle 33680130), then attach the talar dome strike flange (33680132) (fig. 102).

Start insertion of the talar dome component into the joint space by hand to ensure the talar pegs align with the drilled holes in the talus. Remove the tibial tray protector and insert the assembled lipped talar dome impactor assembly. With the ankle in plantar-flexion, put the talar dome strike flange under the anterior lip of the talar dome component to help control possible forward flexion during impaction (fig. 103).

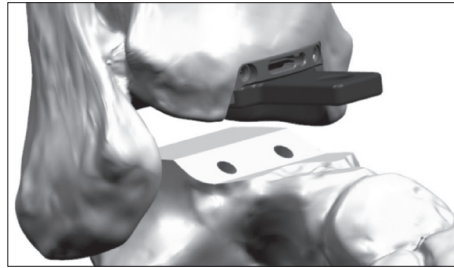

Fig. 101

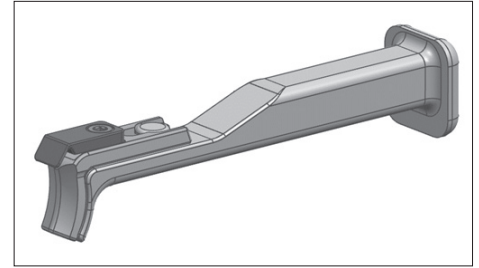

Fig. 102

Lipped talar dome assembly

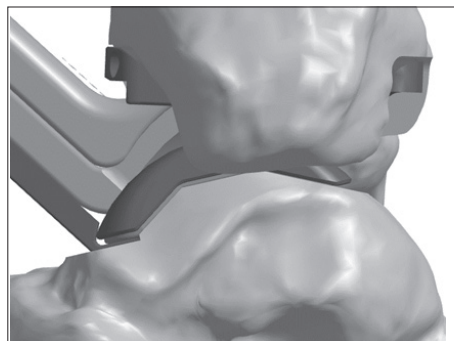

Fig. 103

Lipped talar dome impactor assembly position

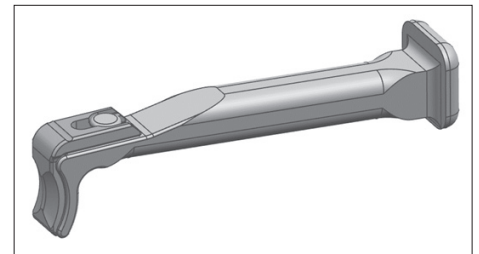

Fig. 104

Legacy talar dome impactor assembly

Strike the lipped talar dome impactor, but do not fully seat the talar dome with the lipped talar impactor assembly. For final implant seating use the legacy talar dome impactor assembly. Remove the lipped talar dome impactor assembly and assemble the legacy talar dome impactor and impactor tip (fig. 104).

With the ankle in plantar-flexion, strike the legacy talar dome impactor assembly until the talus is fully seated. Utilize a lateral fluoroscopic image to verify that the component is fully seated.

Strike flange
33680132



Strike handle
33680130

Strike tip
33680131



Tibial tray protector
33620152 - 33620155

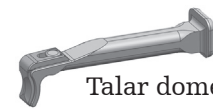

Talar dome impactor
33680130

Impactor tip
33680131

Operative technique

Polyethylene bearing installation

Install two attachment screws (33600190) into the anterior face of the tibial tray (fig. 105).



Fig. 105

Assemble the poly insert guide rail (33600172 – 33600175) onto the poly inserter (33600170) and ensure that the plunger handle is pulled back completely and locked in the start position (fig. 106).

Slide the dovetail feature of the poly insert implant into the poly insert guide rail, ensuring correct A/P orientation of the component (fig. 107).

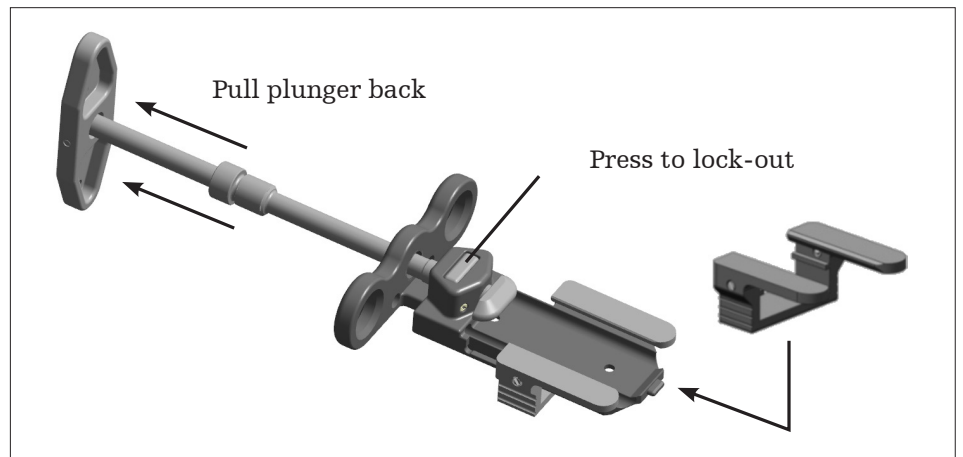

Fig. 106

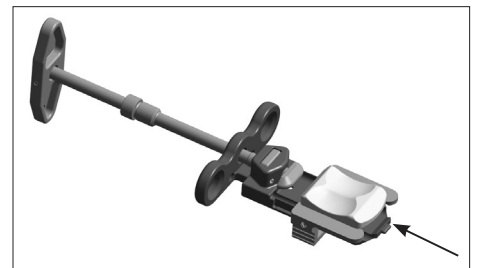

Fig. 107

Operative technique

Slide the poly inserter assembly over the attachment screws and flush to the surface of the tibial tray. Thread an attachment nut (33600191) over the end of each attachment screw to tightly secure the poly inserter in place (fig. 108).

⚠ CAUTION

Properly irrigate prior to poly insertion. It is important to remove any fragments of bone or soft tissue from the lock detail on the tibial tray to ensure that the polyethylene will seat completely within the tibial tray lock detail.



Fig. 108



Attachment nut
33600191

Operative technique

To begin Poly insertion, unlock the plunger and push it forward until it comes into contact with the Poly Inserter housing (fig. 109-110).

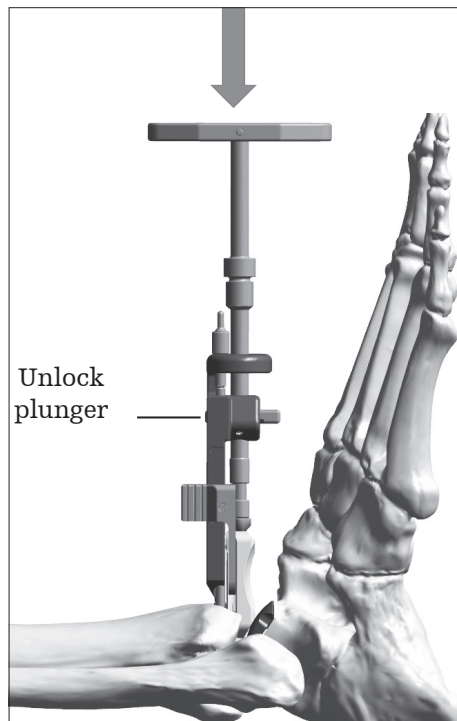

Fig. 109

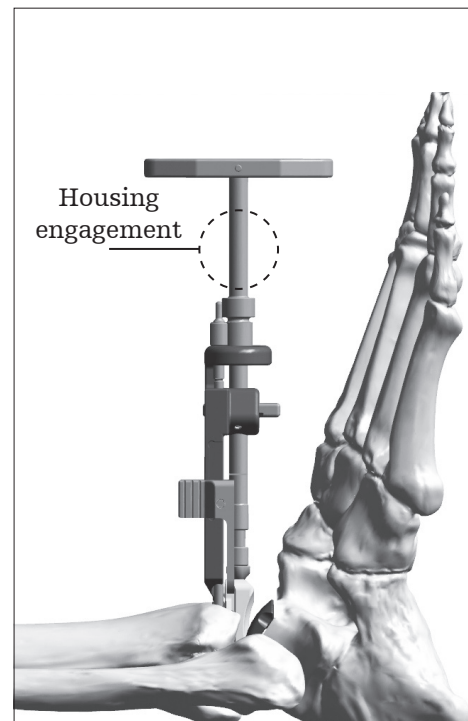

Fig. 110

Once it contacts the housing, the plunger can be turned (clockwise) to continue advancing the poly insert into the tibial tray (fig. 111).

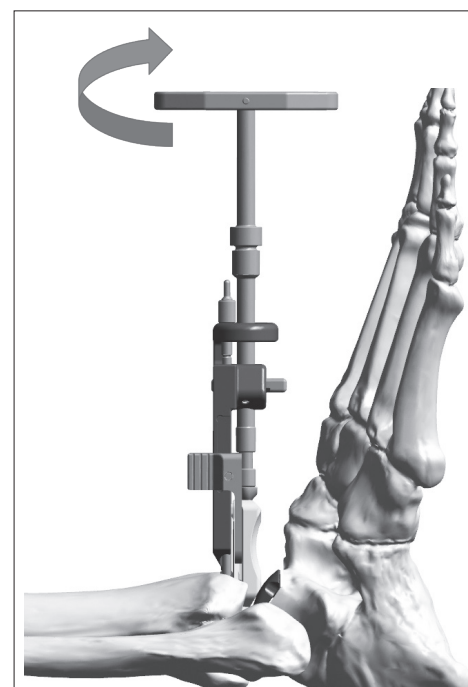

Fig. 111

Operative technique

After the plunger has reached maximum depth, unthread the two attachment nuts, remove the poly inserter housing, and unthread the two attachment screws from the tibial tray (fig. 112).

In some cases, the poly may not fully seat using the insertion tool. In these rare cases only, line up the tip of the straight tibial tray impactor (33600141) with the groove in the anterior face of the poly insert. Angle the impactor slightly and use a gentle distal to proximal mallet strike to complete the seating.



Fig. 112

CAUTION

Striking the impactor with excessive force can result in the tibial tray pegs plowing through cancellous bone, leaving the tibial tray posteriorly translated from the anterior tibia cortex.

Check for proper articulation and observe the range of motion under fluoroscopy, ensuring appropriate gliding mechanics for the prosthesis. Also, perform one final check to be sure all components are appropriately seated. Close the wound and cast foot in slight plantar flexion.

Operative technique

Explant information

Insert replacement

The Poly Insert has a pre-drilled hole feature on the anterior face. To remove the poly insert, first use a pin driver to install the bone removal screw through the pre-drilled hole. Attached the ratcheting handle and pull distally on the removal screw in an attempt to unlock the insert from the tibial tray. A narrow osteotome may be inserted into the anterior region of the insert to facilitate removal. A hemostat may be used to remove the insert once it is no longer locked to the tibial tray. Care must be taken not to scratch or damage any component that is not intended to be removed.

Tibia and Talar components

To remove the components, small osteotomes, power saws, or other surgical instruments may be used to disrupt the bone-cement interface. Care must be exhibited to save remaining bone stock as well as to prevent fracture. Once the components have been removed, rongeurs or small osteotomes as well as other surgical instruments may be used to remove the remaining cement.

If removal of the implant is required, the surgeon should contact the manufacturer using the contact information located on the back cover of this surgical technique to receive instructions for returning the explanted device to the manufacturer for investigation.

Postoperative management

Postoperative care is the responsibility of the medical professional.

Appendix A: Infinity with Adaptis technology

Flat cut talar dome technique

If the surgeon chooses to use an Infinity with Adaptis Technology Flat cut talar dome instead of a standard chamfer-cut infinity with adaptis technology talar dome this is possible due to the identical articulation geometry of the two systems. Follow these steps after the coronal sizing guide is properly positioned (page 23).

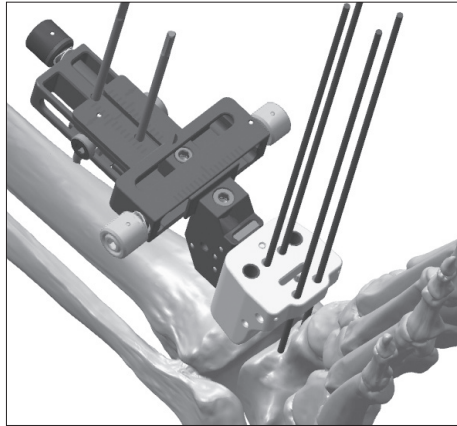

Fig. 113

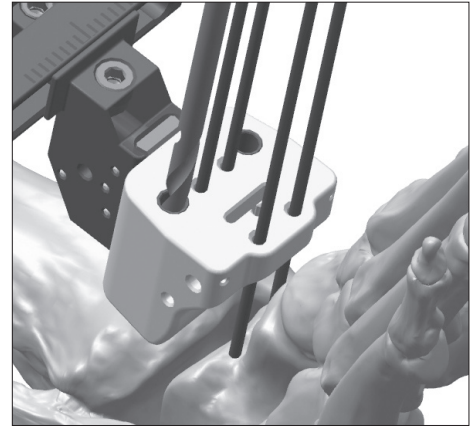

Fig. 114

Bone resection

Ensure that all adjustment block positions are locked out with the hex driver and place four 2.4mm Steinmann pins (200072) into the coronal sizing guide (fig. 113). Place the two tibial pins first then place the talar pins.

CAUTION

During installation of the distal talar pins it is critical that the ankle be positioned at 90°.

Using the tibial corner drill (33600048), bi-cortically drill both proximal corners of the tibia (fig. 114).

Infinity with Adaptis technology

Flat cut talar dome

Remove the coronal sizing guide and slide the appropriately sized flat cut resection guide (33620252 - 33620255) over the four 2.4mm pins and secure into the adjustment block using the hex driver (fig. 115).

Next, install two 2.4mm pins through the inbone/infinity with adaptis technology flat cut talar hole locations (proximal to the slot) and into the talus (fig. 116).

Alternately, the two pin holes distal to the slot can be used if they are accessible and provide better bone purchase.



Fig. 115



Fig. 116

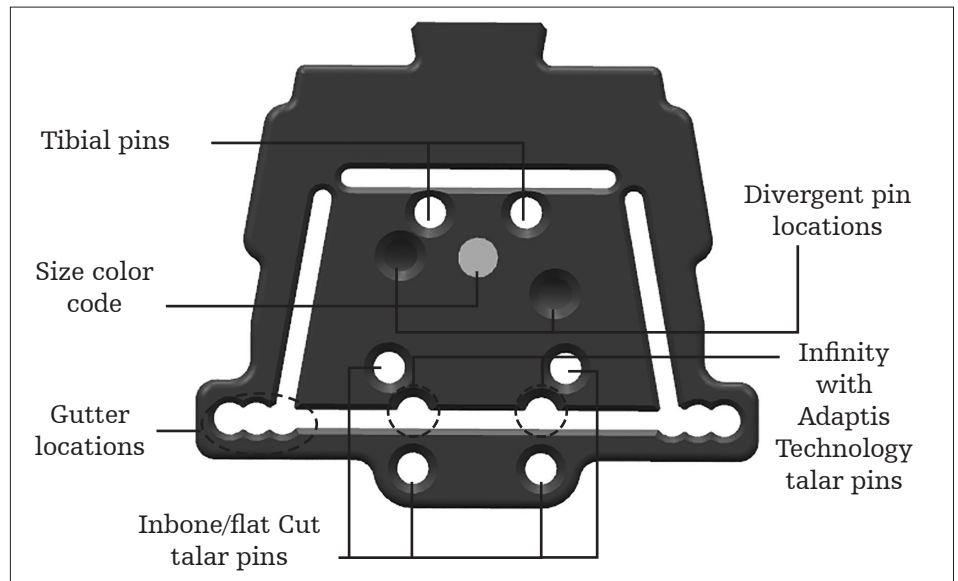

Flat cut resection guide
33620252 – 33620255

Infinity with Adaptis technology

Flat cut talar dome

Remove the two 2.4mm pins from the talar resection slot. Using the pin cutter trim the pins flush to the surface of the resection guide (fig. 117).

Optionally the surgeon can install a 2.4mm steinmann pin into each gutter location and an additional 2.4mm pin through one of the divergent pin locations (fig. 118). When using a divergent pin always use the medial option (in which the pin travels medial to lateral). This will help avoid the neurovascular bundle just behind the medial malleolus.

Using the pin cutter trim the gutter pins flush to the surface of the resection guide. Leave enough length on the divergent pin to allow its later removal with a pin driver or pin puller but short enough to allow saw blade clearance in the medial resection slot (approximately 15mm).

Bone removal & tibial preparation

Refer to pages 28 - 33 for instructions on bone removal and tibia preparation for the infinity with adaptis technology tibial tray.

Implanting tibial tray

Refer to pages 42 - 44 for instructions on the implantation of the infinity with adaptis technology tibial tray.

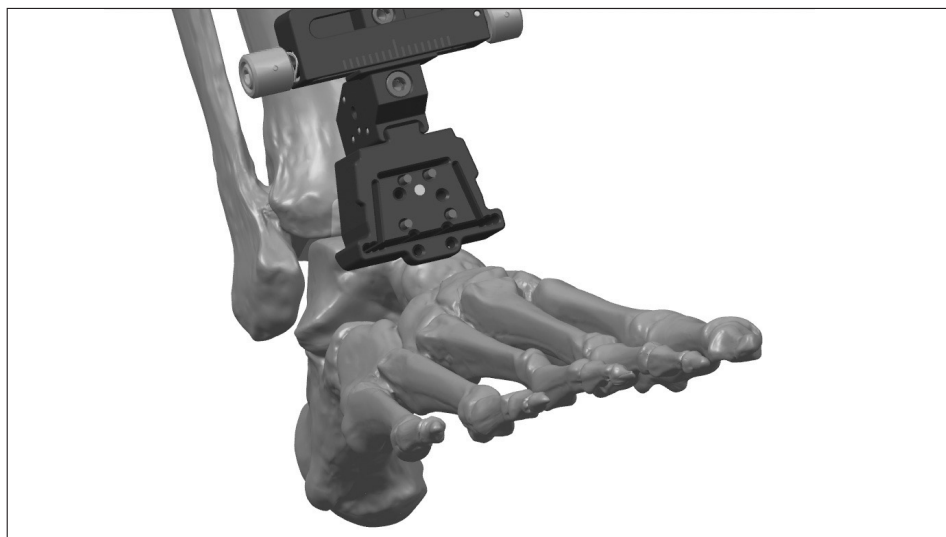

Fig. 117

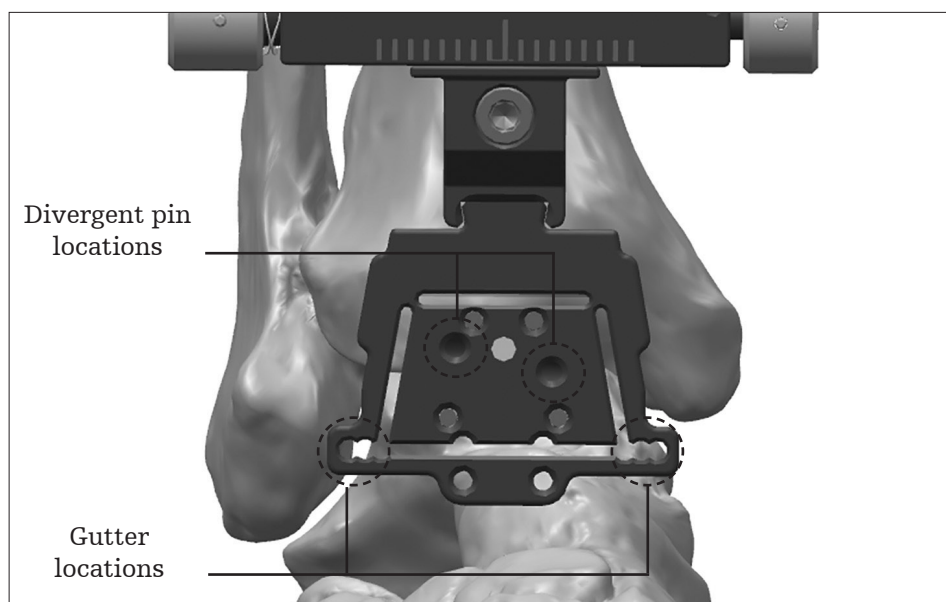

Fig. 118

Infinity with Adaptis technology

Flat cut talar dome

Verify talar dome size

Perform a thorough gutter debridement. The surgeon must be certain that there is no residual bone impinging between the talus and the medial fibula and lateral tibia. The talus must now be completely independent of the remaining ankle joint, free to rotate into its anatomic center of rotation, as well as translate to establish a position beneath the tibial tray. To achieve this, a generous debridement may be necessary.

Using the poly trial holding tool (IB200110) install the appropriately sized poly insert trial (33621106 – 33625512) into the tibial tray (fig. 119). The locking tab of the poly insert trial should engage the tibial tray.

Assemble the appropriately sized flat cut talar dome trial (33680071 - 33680075) and talar dome holding tool (IB200010) and introduce the dome trial into the joint space (fig. 120).

The surgeon has two options for talar dome implant size at this juncture: either the matching size for the implanted tibial tray, or one size smaller. It is beneficial to assess both sizes under A/P and lateral fluoroscopic images.

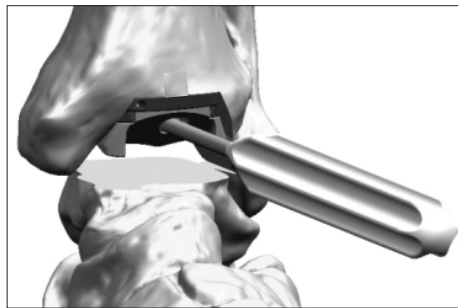

Fig. 119

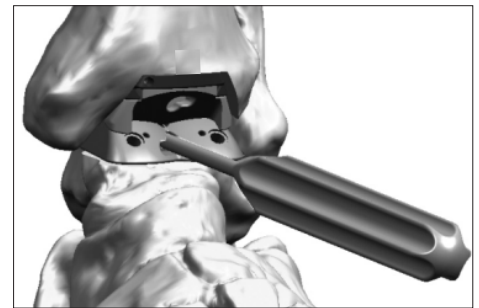

Fig. 120

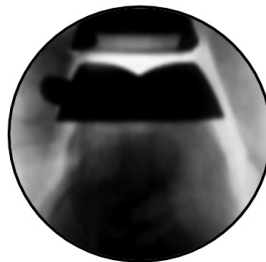

Fig. 121

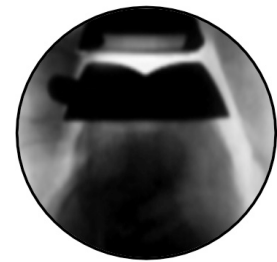
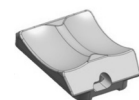

Fig. 122

Please note that the A/P image is critical for sizing the talar component, as the surgeon's goal is to minimize overhang of the talar component, and thus minimize prosthetic impingement in the medial and lateral gutters of the ankle joint (fig. 121-122).



Poly trial holding tool
IB200110



Poly insert trial
33621106 - 33625512



Flat cut talar dome trial
33680071-33680075



Dome trial holding tool
IB200010

Infinity with Adaptis technology

Flat cut talar dome

Trial reduction

Under lateral plane fluoroscopy, ensure the posterior portion of the talar component is resting on the posterior portion of the patient's residual talus (establish congruence) (fig. 123).

While holding the talus in this position, use a marking pen to mark the anterior portion of the talar component with reference to the patient's residual talus.

Be sure to observe the talar component with reference to the line on the residual talus previously drawn. This will ensure the talar component does not migrate anteriorly during the range of motion.

To accurately perform the range of motion, place some axial compression of the components to maintain position, and flex and extend the ankle. The surgeon will observe the talar component rotating into the anatomic position for this particular patient. Note that the surgeon must not only be cognizant of the talar position in the lateral plane, but must simultaneously maintain medial/lateral coverage as evidenced by the previous A/P plane fluoroscopic views.



Fig. 123



Fig. 124

Once the talar dome trial has settled into optimum anatomical position, install two 1.4mm pins (500036) through the talar dome trial to temporarily hold it in place (fig. 124).

NOTICE

With the talar component pinned in position, the surgeon should once again place the ankle through a range of motion to ensure tibio-talar articular congruence. Also, confirm through lateral fluoroscopy that the prosthesis did not shift anteriorly.

Refer back to page 43 for further details on choosing the appropriate polyethylene thickness.

Infinity with Adaptis technology

Flat cut talar dome

Talar preparation

Use the poly insert trial holding tool to remove the poly insert trial. The foot may be plantarflexed to aid in removal of poly insert trial (fig. 125-126).

CAUTION

The poly insert trial has a small locking tab that engages the tibial tray. To remove poly insert trial, be sure to first pull down on the holding tool to disengage tab before pulling out.

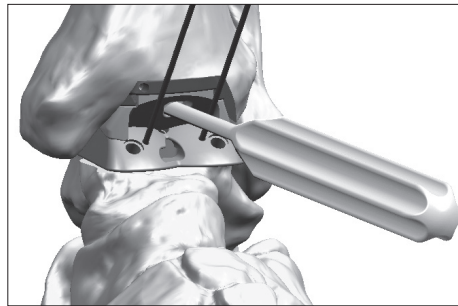

Fig. 125

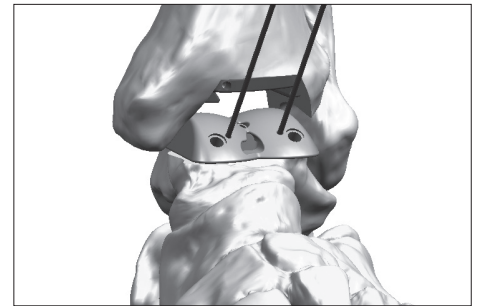

Fig. 126

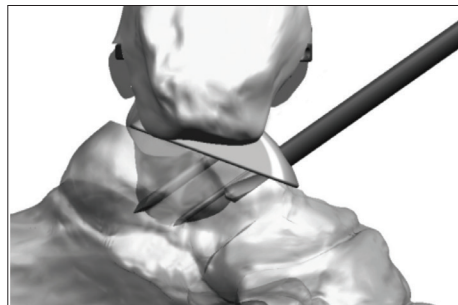

Fig. 127



Using the 4mm anterior peg drill (IB200020), drill a hole through the medial and lateral anterior openings and the central posterior opening in the flat cut talar dome trial. The drill has a hard stop designed to set the appropriate drilling depth in the talus for the talar dome anterior pegs (fig. 127).

Remove 1.4mm pins and flat cut talar dome trial.

Infinity with Adaptis technology

Flat cut talar dome

Install talar dome

Place the foot in plantar flexion and insert the tibial tray protector (33620152 - 33620155) into the tibial tray to protect the talar dome surface during installation. If choosing to cement, apply bone cement to the bottom surface of the talar dome.

Thread the M4 Holding Tool (200364003) into either corner of the Talar Dome and introduce the Talar Dome into the joint space, aligning the Talar Stem and pegs with the prepared holes in the talus (fig. 128). Once the Talar Dome is aligned, remove the Tray Protector.

Align the talar dome impactor (IB200030 and IB200031) on the talar dome and with a mallet, hit the top of the impactor to fully seat the talar dome (fig. 129). Utilize a lateral fluoroscopic image to ensure that the talar dome is fully seated. If the talar dome is difficult to fully seat in hard bone, it may be advisable to remove the talar dome and increase the diameter of the peg holes slightly with the 4mm drill.

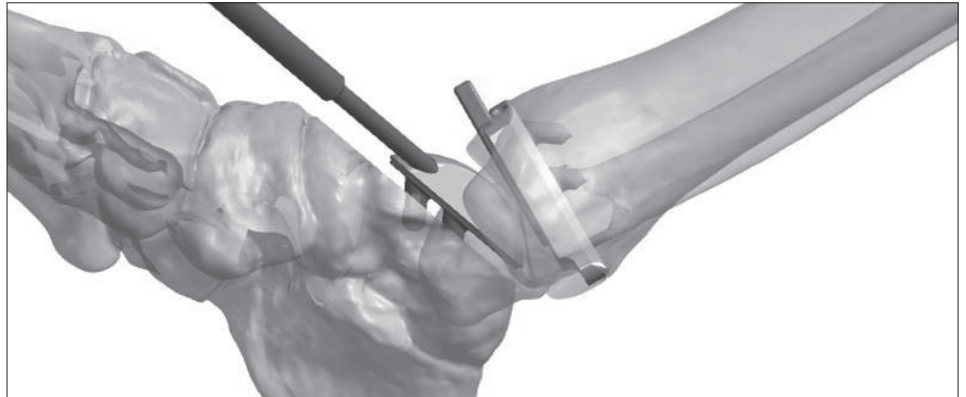

Fig. 128

Install poly insert

Following final impaction of the talar dome, refer to pages 46 - 50 for instructions on poly insert installation.

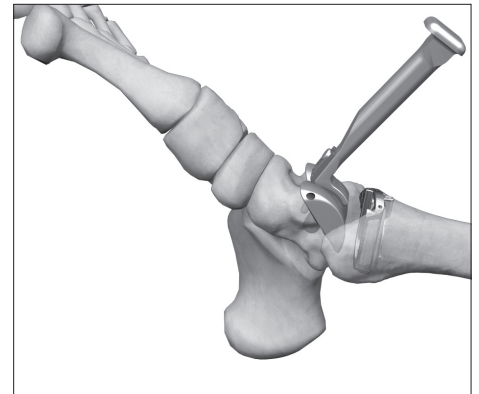
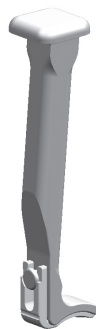
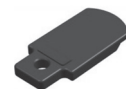

Fig. 129



Talar dome impactor
IB200030
Impactor tip
IB200031



Tibial tray protector
33620152 - 33620155



M4 holding tool
200364003

Appendix B: Talar re-cut option

After the talar resection is made, the surgeon still has an option to make an additional 2mm talar re-cut. Thread the insertion handle (33600130) into the talar recut guide (33609056) and introduce the guide into the joint space. Make sure the paddle of the guide is seated flat on the resected talus and install two 2.4mm steinmann pins through the guide into the talus (fig. 130).

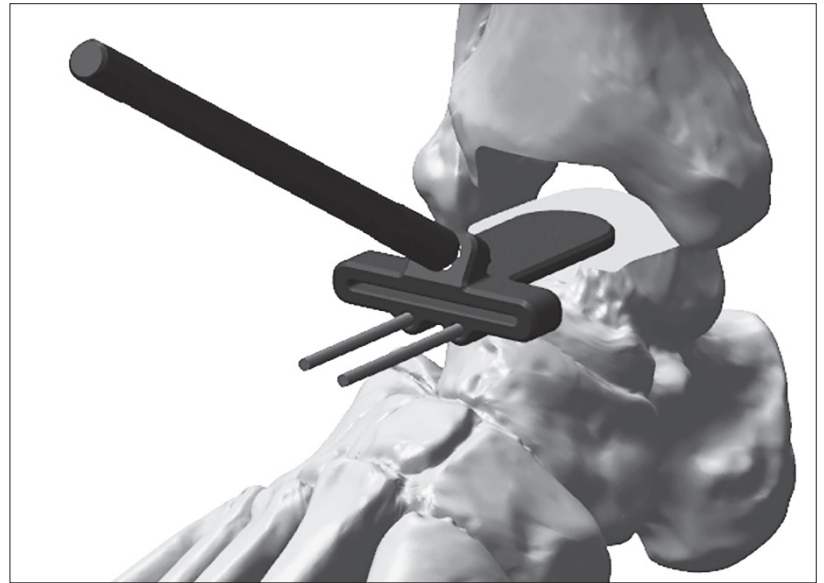

Fig. 130

Make an additional 2mm talar bone resection through the slot of the resection guide (Fig. 131).



Insertion handle
33600130



Talar recut guide
33609056

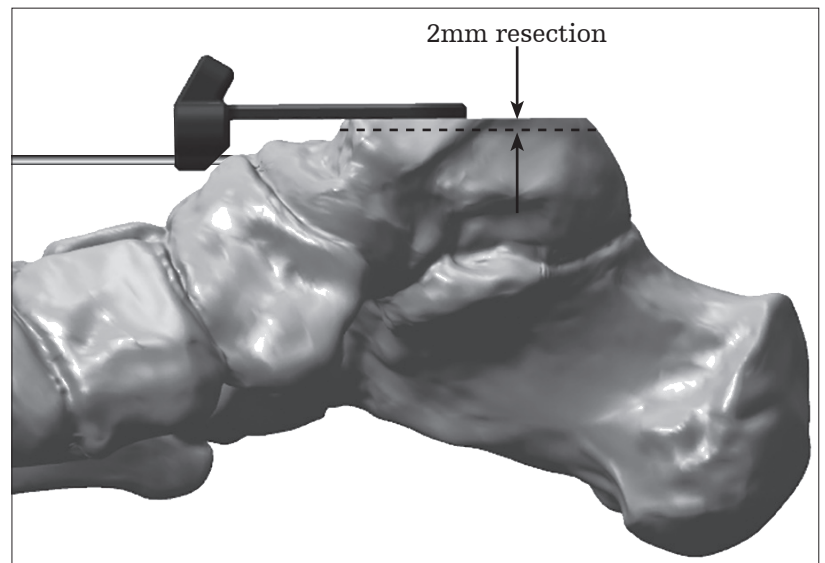
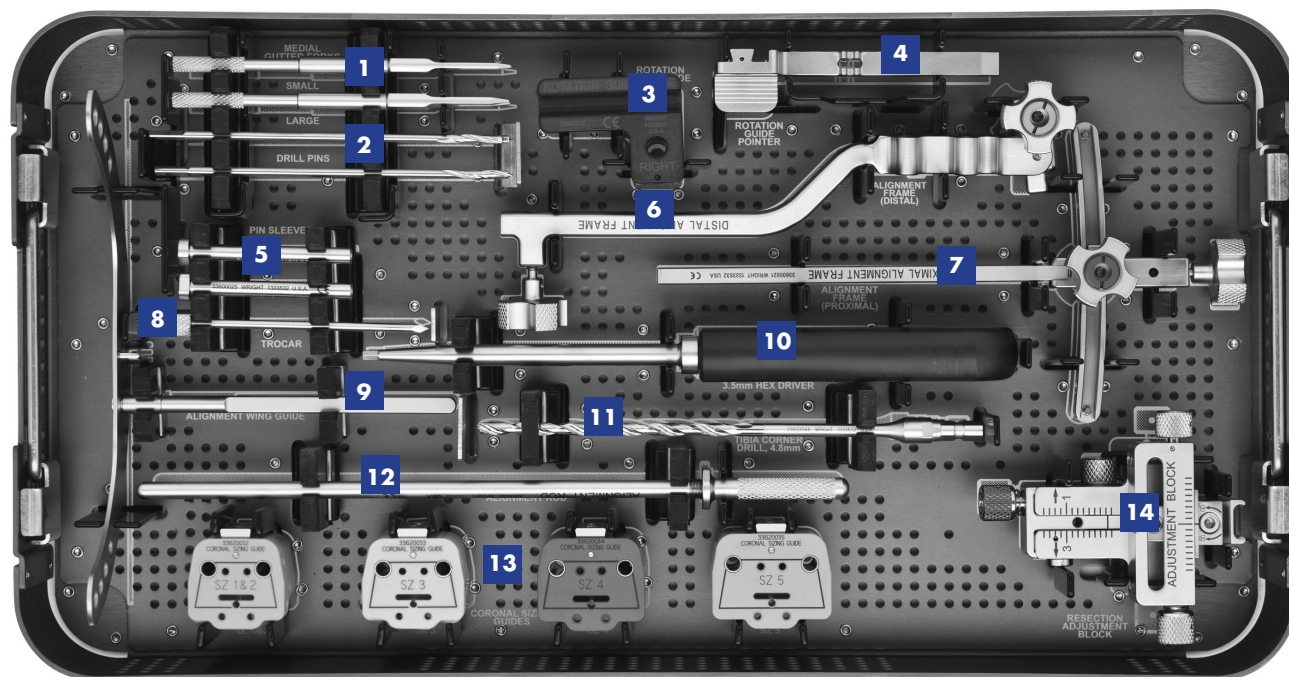

Fig. 131

Appendix C: Infinity with Adaptis Technology Instrumentation



Case 1, Tray 1

3365KIT1

Item	Ref #	Description
1	33600009 & 33600010	Medial gutter forks
2	33610001	Pins 3.2mm x 102mm
3	33600012	Rotation guide slide
4	33600011	Rotation guide pointer
5	33600025	Pin sleeves
6	33600020	Alignment frame distal assembly
7	33600021	Alignment frame proximal assembly
8	33600026	Trocar
9	33600023	Alignment wing guide
10	E5001005	3.5mm hex driver
11	33600048	4.8mm tibial corner drill
12	33600024	Alignment rod
13	33620032 - 33620035	Coronal sizing guides
14	33600030	Resection guide adjustment block

Infinity with Adaptis Technology Instrumentation

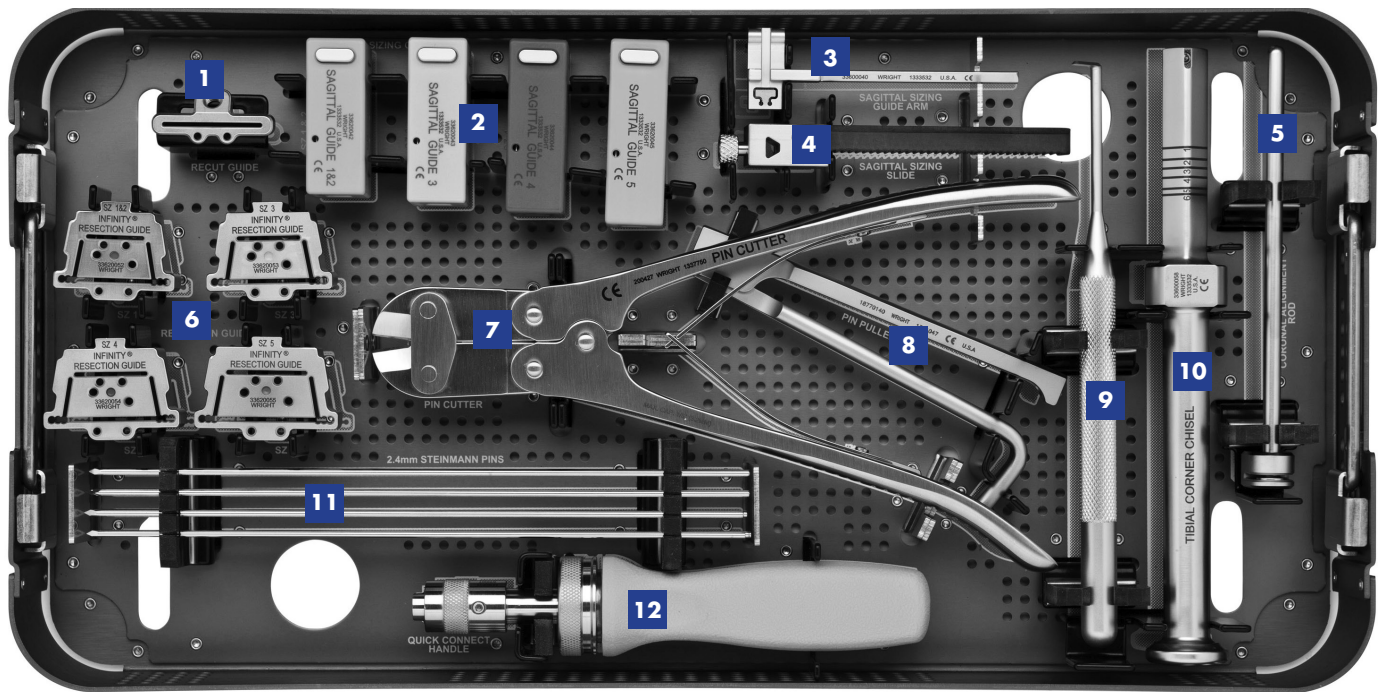

Case 1, Tray 2

3365KIT1

Item	Ref #	Description
1	33609056	Talar 2mm recut guide
2	33620042 - 33620045	Sagittal sizing guides
3	33600040	Sagittal sizing guide arm
4	33600068	Sagittal sizing guide ratchet arm
5	33600027	Coronal alignment rod
6	33620052 - 33620055	Resection guides
7	200427	Pin cutter
8	18770140	Pin puller
9	IB200050	Bone release tool
10	33600058	Tibia corner chisel
11	200072	Steinmann pins 2.4mm
12	44180025	Quick connect handle

Infinity with Adaptis Technology Instrumentation

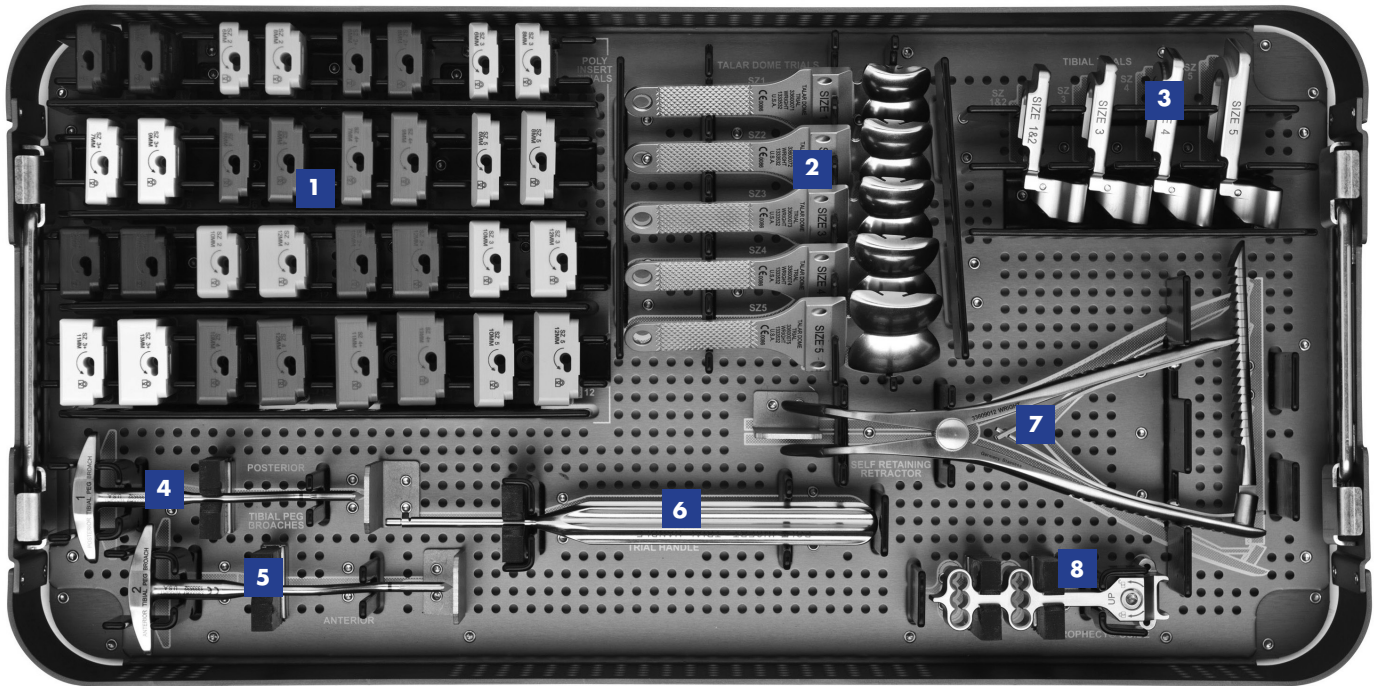

Case 2, Tray 1

3365KIT1

Item	Ref #	Description
1	33621106 - 33625512	Poly insert trials
2	33600071 - 33600075	Talar dome trials
3	33620062 - 33620065	Tibial tray trials
4	33600069	Posterior tibial peg broach
5	33600067	Anterior tibial peg broach
6	IB200110	Poly trial handle
7	33609012	Self retaining retractor
8	33600200	Prophecy conversion guide

Infinity with Adaptis Technology Instrumentation

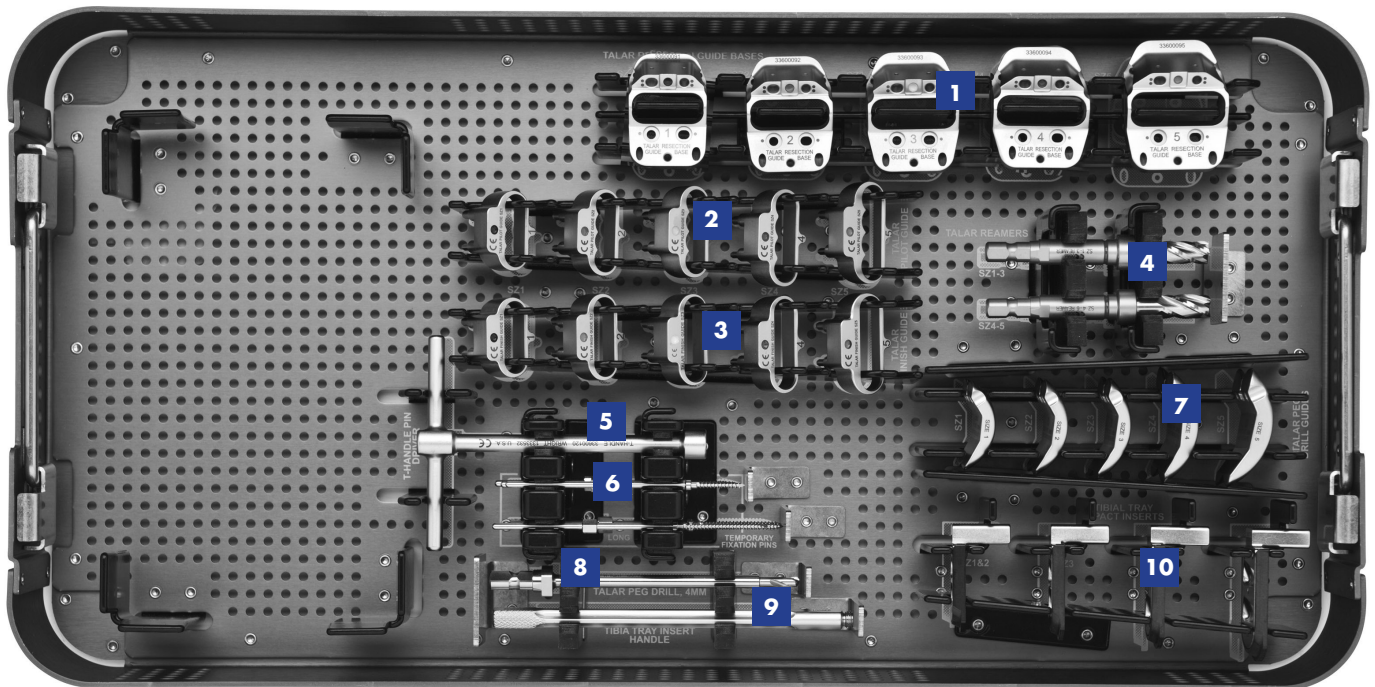

Case 2, Tray 2

3365KIT1

Item	Ref #	Description
1	33600091 - 33600095	Talar resection guide bases
2	33600101 - 33600105	Talar chamfer pilot guides
3	33600111 - 33600115	Talar chamfer finish guides
4	33600123 & 33600126	Talar reamers
5	33600120	T-handle pin driver
6	33610002 & 33610003	Threaded talar pins
7	33600161 - 33600165	Talar peg drill guides
8	IB200020	Talar peg drill, 4mm
9	33600130	Tibial tray insertion handle
10	33620132 - 33620135	Tibial tray impaction inserts

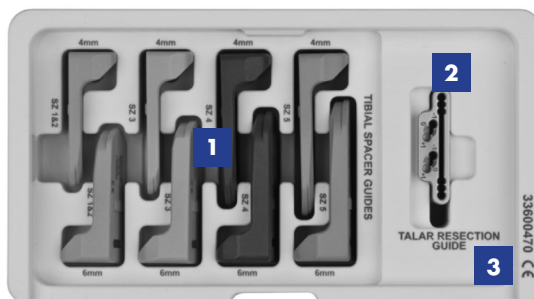

Case 2, Caddy 1

Item	Ref #	Description
1	33600424 - 33600456	Tibial spacer guides
2	33600400	Talar resection guide
3	33600470	Caddy

Infinity with Adaptis Technology Instrumentation

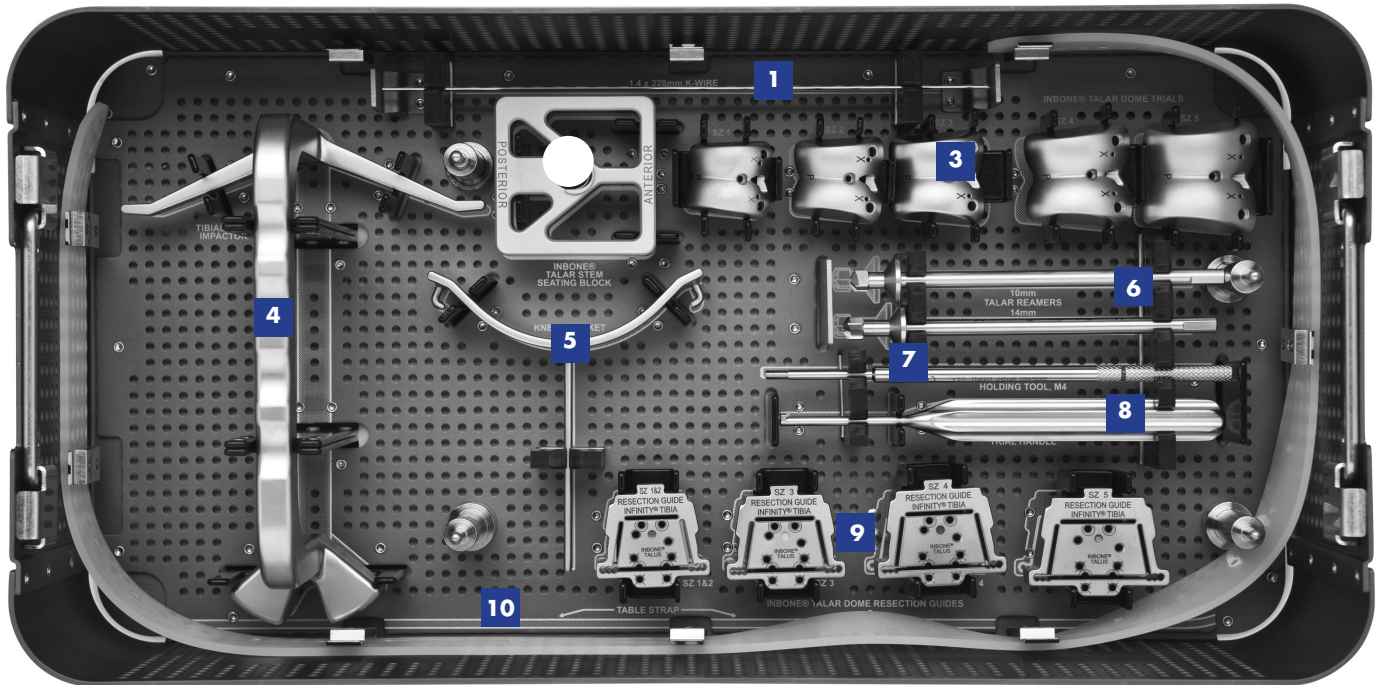

Case 3, Tray 1

3365KIT1

Item	Ref #	Description
1	500036	K-wires 1.4mm x 228mm
2	IB200060	Inbone talar stem seating block
3	IB220901 – IB220905	Inbone talar dome trials
4	33600140	Tibial tray offset impactor
5	33600022	Knee bracket
6	200432010 & 200432014	Inbone talar stem reamers
7	200364003	Inbone talar dome m4 holding tool
8	IB200010	Inbone talar dome trial handle
9	33620252 - 33620255	Inbone talar dome resection guides
10	200430	Table strap

Infinity with Adaptis Technology Instrumentation

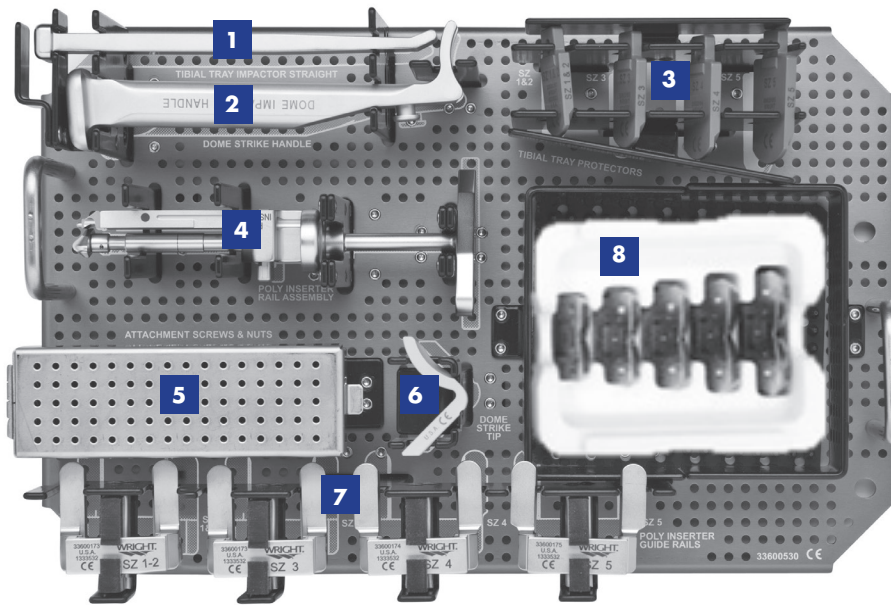

Case 3, Tray 2

3365KIT1

Item	Ref #	Description
1	33600141	Straight impactor
2	IB200030	Dome strike handle
3	33620152 - 33620155	Tibial tray protectors
4	33600170	Poly inserter assembly
5	33600190 & 33600191	Attachment screws & nuts
6	IB200031	Dome strike tip
7	33600172 - 33600175	Poly inserter guide rails ()
8	33680071-33680075	Infinity with Adaptis Technology flat cut trials

Infinity with Adaptis Technology Instrumentation

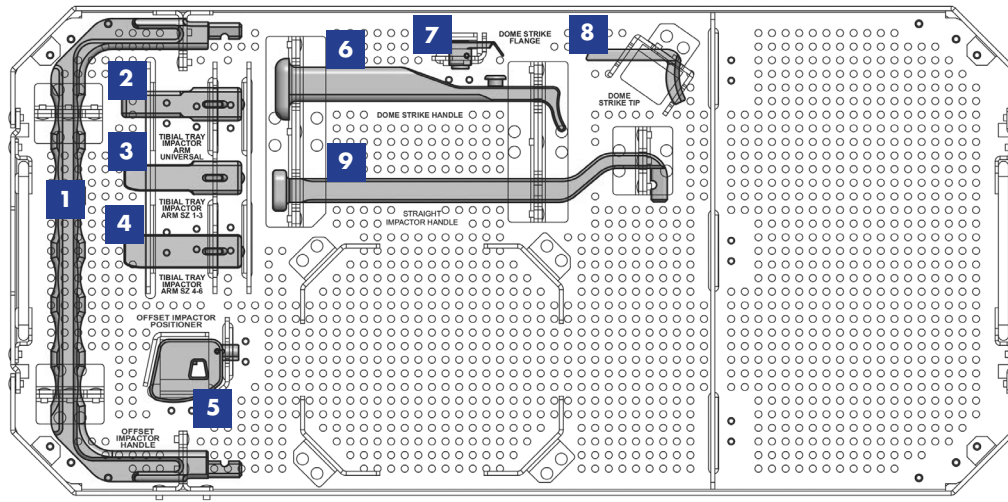

Case 1, Tray 1

3368KIT2

Item	Ref #	Description
1	33680140	Offset impactor handle
2	33680143	Tibial tray impactor arm universal
3	33680142	Tibial tray impactor arm size 1-3
4	33680144	Tibial tray impactor arm size 4-6
5	33680145	Offset impactor positioner
6	33680130	Dome strike handle
7	33680132	Dome strike flange
8	33680131	Dome strike tip
9	33680141	Straight impactor handle

Infinity with Adaptis Technology Instrumentation

Infinity with Adaptis Technology instrument kit

3365KIT1

Ref #	Description	Ref #	Description
33600009	Medial gutter fork, small	33620062	Trial tibial tray, sz1-2
33600010	Medial gutter fork, large	33620063	Trial tibial tray, sz3
33600011	Rotation guide pointer	33620064	Trial tibial tray, sz4
33600012	Rotation guide slide	33620065	Trial tibial tray, sz5
33600020	Alignment frame dist sub assy	33600069	Tibial peg drill, 3.7mm
33600021	Alignment frame prox sub assy	33600071	Trial talar dome, sz1
33600022	Knee bracket	33600072	Trial talar dome, sz2
33600023	Alignment wing guide	33600073	Trial talar dome, sz3
33600024	Alignment rod	33600074	Trial talar dome, sz4
33600025	Pin sleeve	33600075	Trial talar dome, sz5
33600026	Trocar	33600091	Talar resect guide base, sz1
33600030	Resection adjustment block	33600092	Talar resect guide base, sz2
33620032	Coronal sizing guide, sz 1-2	33600093	Talar resect guide base, sz3
33620033	Coronal sizing guide, sz 3	33600094	Talar resect guide base, sz4
33620034	Coronal sizing guide, sz 4	33600095	Talar resect guide base, sz5
33620035	Coronal sizing guide, sz 5	33600101	Anter talar pilot guide, sz1
33620040	Sagittal sizing guide arm	33600102	Anter talar pilot guide, sz2
33620042	Sagittal sizing guide, sz1-2	33600103	Anter talar pilot guide, sz3
33620043	Sagittal sizing guide, sz3	33600104	Anter talar pilot guide, sz4
33620044	Sagittal sizing guide, sz4	33600105	Anter talar pilot guide, sz5
33620045	Sagittal sizing guide, sz5	33600111	Anter talar finish guide, sz1
33600048	Tibial corner drill, 4.8mm	33600112	Anter talar finish guide, sz2
33620052	Resection guide, sz 1-2	33600113	Anter talar finish guide, sz3
33620053	Resection guide, sz 3	33600114	Anter talar finish guide, sz4
33620054	Resection guide, sz 4	33600115	Anter talar finish guide, sz5
33620055	Resection guide, sz 5	33600120	T-handle pin driver
33600058	Tibial corner chisel	33600123	Talar reamer, sz 1-3
		33600126	Talar reamer, sz 4-6

Infinity with Adaptis Technology Instrumentation

Infinity with Adaptis Technology instrument kit

3365KIT1

Ref #	Description	Ref #	Description
33600130	Tibial tray insert handle	33621106	Trial poly insert, sz1/1+ 6mm
33620132	Tib tray impact insert, sz1-2	33621108	Trial poly insert, sz1/1+ 8mm
33620133	Tib tray impact insert, sz3	33621110	Trial poly insert, sz1/1+ 10mm
33620134	Tib tray impact insert, sz4	33621112	Trial poly insert, sz1/1+ 12mm
33620135	Tib tray impact insert, sz5	33622206	Trial poly insert, sz2 6mm
33600140	Tibial tray impactor, offset	33622208	Trial poly insert, sz2 8mm
33600141	Tibial tray impactor, straight	33622210	Trial poly insert, sz2 10mm
33620152	Tibial tray protector, sz1-2	33622212	Trial poly insert, sz2 12mm
33620153	Tibial tray protector, sz3	33623206	Trial poly insert, sz2+ 6mm
33620154	Tibial tray protector, sz4	33623208	Trial poly insert, sz2+ 8mm
33620155	Tibial tray protector, sz5	33623210	Trial poly insert, sz2+ 10mm
33600161	Talar peg drill guide, sz1	33623212	Trial poly insert, sz2+ 12mm
33600162	Talar peg drill guide, sz2	33623306	Trial poly insert, sz3 6mm
33600163	Talar peg drill guide, sz3	33623308	Trial poly insert, sz3 8mm
33600164	Talar peg drill guide, sz4	33623310	Trial poly insert, sz3 10mm
33600165	Talar peg drill guide, sz5	33623312	Trial poly insert, sz3 12mm
33600170	Poly inserter rail assy	33624307	Trial poly insert, sz3+ 7mm
33600172	Poly insert guide rail, sz1-2	33624309	Trial poly insert, sz3+ 9mm
33600173	Poly insert guide rail, sz3	33624311	Trial poly insert, sz3+ 11mm
33600174	Poly insert guide rail, sz4	33624313	Trial poly insert, sz3+ 13mm
33600175	Poly insert guide rail, sz5	33624406	Trial poly insert, sz4 6mm
33600190	Poly insert attachment screw	33624408	Trial poly insert, sz4 8mm
33600191	Poly insert attachment nut	33624410	Trial poly insert, sz4 10mm
33620252	Resection guide inbone talus, sz1-2	33624412	Trial poly insert, sz4 12mm
33620253	Resection guide inbone talus, sz3	33625407	Trial poly insert, sz4+ 7mm
33620254	Resection guide inbone talus, sz4	33625409	Trial poly insert, sz4+ 9mm
33620255	Resection guide inbone talus, sz5	33625411	Trial poly insert, sz4+ 11mm
		33625413	Trial poly insert, sz4+ 13mm
		33625506	Trial poly insert, sz5 6mm
		33625508	Trial poly insert, sz5 8mm
		33625510	Trial poly insert, sz5 10mm
		33625512	Trial poly insert, sz5 12mm

Infinity with Adaptis Technology Instrumentation

Infinity with Adaptis Technology instrument kit

3365KIT1

Ref #	Description
33609012	Self retaining laminar spreaders
33610001	Pin 3.2mm x 102mm
33610002	Temp fix pin, talar guide long
33610003	Temp fix pin, talar guide short
E5001005	Evolution® 3.5mm hex driver
200430	Inbone table strap
200072	Inbone steinmann pin, 2.4mm
IB200050	Inbone bone release tool
IB200110	Poly trial handle
IB200020	Inbone drill talar peg, 4mm
IB200030	Inbone handle dome striker
IB200031	Inbone® dome strike tip sulcus
500036	1.4mm k-wire
18770140	Ortholoc™ pin puller
200427	Inbone pin cutter 3.2
44180025	7.0 Muc handle quick connect
IB220901	Inbone trial tal dome #1 sulc
IB220902	Inbone trial tal dome #2 sulc
IB220903	Inbone trial tal dome #3 sulc
IB220904	Inbone trial tal dome #4 sulc
IB220905	Inbone trial tal dome #5 sulc
200432010	Inbone talar reamer, 10 mm
200432014	Inbone talar reamer, 14 mm
IB200060	Inbone seat block talar stem
IB200010	Inbone talar dome trial handle
200364003	Inbone holding, tool, m4
33600200	Prophecy conversion instrument

Ref #	Description
33600400	Talar resection guide
33600424	Tibial spacer guide, sz1&2
33600426	Tibial spacer guide, sz1&2 std
33600434	Tibial spacer guide, sz3 minus
33600436	Tibial spacer guide, sz3 std
33600444	Tibial spacer guide, sz4 minus
33600446	Tibial spacer guide, sz4 std
33600454	Tibial spacer guide, sz5 minus
33600456	Tibial spacer guide, sz5 std
33600470	Caddy, tibial spacer guide

Infinity with Adaptis Technology instrument kit

TARKIT1

Ref #	Description
33680071	Flat cut trial, sz 1
33680072	Flat cut trial, sz 2
33680073	Flat cut trial, sz 3
33680074	Flat cut trial, sz 4
33680075	Flat cut trial, sz 5
33680000	Flat cut trial caddy

Infinity with Adaptis Technology instrument kit

3368KIT2

Ref #	Description
33680130	Dome strike handle
33680131	Dome strike tip
33680132	Dome strike flange
33680140	Offset impactor handle
33680141	Straight impactor handle
33680142	Tibial tray impactor arm size 1-3
33680143	Tibial tray impactor arm universal
33680144	Tibial tray impactor arm size 4-6
33680145	Offset impactor positioner

Appendix D: Ordering Information

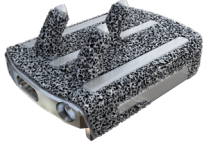

Infinity with Adaptis Technology Tibial component

Ref #	Description
33680001	Tibial tray sz 1 std
33680002	Tibial tray sz 2 std
33680003	Tibial tray sz 3 std
33680004	Tibial tray sz 4 std
33680005	Tibial tray sz 5 std
33680013	Tibial tray sz 3 lng
33680014	Tibial tray sz 4 lng
33680015	Tibial tray sz 5 lng



Infinity with Adaptis Technology Chamfer-cut talar component

Ref #	Description
33680021	Talar dome sz 1
33680022	Talar dome sz 2
33680023	Talar dome sz 3
33680024	Talar dome sz 4
33680025	Talar dome sz 5



Infinity with Adaptis Ttechnology Flat cut talar dome

Ref #	Description
33680031	Size #1, right & left
33680032	Size #2, right & left
33680033	Size #3, right & left
33680034	Size #4, right & left
33680035	Size #5, right & left

Ordering Information

Accessories

Ref #	Description
IB200051	Bone removal screw
200138101S	Saw blade stryker system 5 narrow
200138102S	Saw blade stryker system 5 wide
200138105S	Saw blade stryker system 6 narrow
200138106S	Saw blade stryker system 6 wide
200138107S	Saw blade stryker system 7 narrow
200138108S	Saw blade stryker system 7 wide

Ordering Information



Infinity everlast poly insert

Ref #	Description
33681106	Infinity everlast sz 1/1 +6mm
33681108	Infinity everlast sz 1/1 +8mm
33681110	Infinity everlast sz 1/1 +10mm
33681112	Infinity everlast sz 1/1 +12mm
33682206	Infinity everlast sz 2 6mm
33682208	Infinity everlast sz 2 8mm
33682210	Infinity everlast sz 2 10mm
33682212	Infinity everlast sz 2 12mm
33683206	Infinity everlast sz 2 +6mm
33683208	Infinity everlast sz 2 +8mm
33683210	Infinity everlast sz 2 +10mm
33683212	Infinity everlast sz 2 +12mm
33683306	Infinity everlast sz 3 6mm
33683308	Infinity everlast sz 3 8mm
33683310	Infinity everlast sz 3 10mm
33683312	Infinity everlast sz 3 12mm
33684307	Infinity everlast sz 3 +7mm
33684309	Infinity everlast sz 3 +9mm
33684311	Infinity everlast sz 3 +11mm
33684313	Infinity everlast sz 3 +13mm
33684406	Infinity everlast sz 4 6mm
33684408	Infinity everlast sz 4 8mm
33684410	Infinity everlast sz 4 10mm
33684412	Infinity everlast sz 4 12mm
33685407	Infinity everlast sz 4 +7mm
33685409	Infinity everlast sz 4 +9mm
33685411	Infinity everlast sz 4 +11mm
33685413	Infinity everlast sz 4 +13mm
33685506	Infinity everlast sz 5 6mm
33685508	Infinity everlast sz 5 8mm
33685510	Infinity everlast sz 5 10mm
33685512	Infinity everlast sz 5 12mm

This document is intended solely for the use of healthcare professionals. A surgeon must always rely on his or her own professional clinical judgment when deciding whether to use a particular product when treating a particular patient. Stryker does not dispense medical advice and recommends that surgeons be trained in the use of any particular product before using it in surgery.

The information presented is intended to demonstrate a Stryker product. A surgeon must always refer to the product label and/or Instructions for Use, including the instructions for Cleaning and Sterilization (if applicable), before using any Stryker product. Products may not be available in all markets because product availability is subject to the regulatory and/or medical practices in individual markets. Please contact your Stryker representative if you have questions about the availability of Stryker products in your area.

The Instructions for Use, Operative Techniques, Cleaning instructions, patient information leaflets and other associated labeling may be requested online at www.ifu.stryker.com. If saving the Instructions for Use, Operative Techniques, Cleaning instructions from the above mentioned websites, please make sure you always have the most up to date version prior to use.

Stryker Corporation or its divisions or other corporate affiliated entities own, use or have applied for the following trademarks or service marks: Adaptis, Infinity, Stryker, Tornier, Wright Medical Technology. All other trademarks are trademarks of their respective owners or holders.

The products listed above are CE marked.

Content ID: AP-015115B, 12-2023
Copyright © 2023 Stryker



2797

Manufacturer:
Wright Medical Technology, Inc.
1023 Cherry Road
Memphis, TN 38117
stryker.com

Authorised representative:
Tornier SAS
161 Rue Lavoisier
38330 Montbonnot Saint Martin
France