

Hoffmann® LRF

Circular External Fixation



Operative technique



Hoffmann LRF

Circular External Fixation

Contents

1. Indications and contraindications	3
2. Introduction	5
3. Key components	6
Rings	7
Ring types	8
Foot arches	9
Rocker shoes	10
Wire bolt, wire bolt adaptor	11
Apex pin adaptor, apex pin bolt	12
Connecting nut	13
Telescopic struts	14
Threaded rods	20
Hinge couplings	21
Static struts	22
4. Key instruments	23
Fixation components wrenches	23
Wire tensioner	24
Recommended tension levels	25
Wire tensioner disassembly	25
5. Operative technique	26
Sleeve system	27
6. Frame examples	30
Static foot & ankle frame	32
Tibial shaft frame	34
Proximal tibial (plateau) frame	36
Distal tibial frame	38
Distal radius frame	40

This publication sets forth detailed recommended procedures for using Stryker devices and instruments.

It offers guidance that you should heed, but, as with any such technical guide, each surgeon must consider the particular needs of each patient and make appropriate adjustments when and as required.

A workshop training is recommended prior to performing your first surgery. All non-sterile devices must be cleaned and sterilized before use. Follow the instructions provided in our cleaning and sterilization guide (OT-RG-1).

Multi-component instruments must be disassembled for cleaning. Please refer to the corresponding assembly/disassembly instructions. Please remember that the compatibility of different product systems have not been tested unless specified otherwise in the product labeling.

See package insert (Instruction for Use) (V15013, V15034, V15011) for a complete list of potential adverse effects, contraindications, warnings and precautions. The surgeon must discuss all relevant risks including the finite lifetime of the device with the patient when necessary.

Note:

For a complete overview of the entire Hoffmann LRF System, it is recommended that the user also references the Hoffmann LRF Gradual Correction operative technique (H-ST-2), Hoffmann LRF bone transport operative technique (H-ST-31), the Hoffmann LRF Hexapod operative technique (H-ST-34) the Patient Guide for External Fixation (H-PG-1), the Hoffmann LRF Hexapod Hole Offset Guide (H-ADI-1), and the Hoffmann LRF Web Application user manual (H-IFU-2).

Indications & contraindications

Indications for use

The Hoffmann LRF System is indicated in pediatric patients and adults for the treatment and fixation of:

- Open and closed fractures
- Post-traumatic joint contracture which has resulted in loss of range of motion
- Fractures and disease which generally may result in joint contractures or loss of range of motion and fractures requiring distraction
- Pseudoarthrosis or non-union of long bones
- Limb lengthening by epiphyseal, diaphyseal, or metaphyseal distraction
- Correction of bony or soft tissue deformity
- Correction of segmental bony or soft tissue defects
- Joint arthrodesis
- Management of communicated intra-articular fractures of the distal radius
- Bone transport

The Hoffmann LRF System is indicated in adults for:

- Osteotomy
- Revision procedure where other treatments or devices have been unsuccessful
- Bone reconstruction procedures
- Fusions and replantations of the foot
- Charcot foot reconstruction
- Lisfranc dislocations

Intended use

The Hoffmann LRF (Limb Reconstruction Frame) System is intended for fixation of fractures, joint contractures, fusions, limb lengthening, deformity correction, bone and soft tissue reconstruction in pediatric patients and adults.

Contraindications

Since external fixation devices are often used in emergency situations to treat patients with acute injuries, there are no absolute contraindications for use. The surgeon's education, training and professional judgment must be relied upon to choose the most appropriate device and treatment for each individual patient. Whenever possible, the device chosen should be of a type indicated for the fracture being treated and/or for the procedure being utilized.

Conditions presenting an increased risk of failure include:

1. Insufficient quantity or quality of bone which would inhibit appropriate fixation of the device.
2. Compromised vascularity that would inhibit adequate blood supply to the fracture or operative site.
3. Previous history of infections.
4. Any neuromuscular deficit which could interfere with the patient's ability to limit weight bearing.
5. Any neuromuscular deficit which places an unusually heavy load on the device during the healing period.
6. Malignancy in the fracture area.
7. Mental, physical or neurological conditions which may impair the patient's ability to cooperate with the postoperative regimen.

Indications & contraindications

Precautions

Information for patient. Surgeons must instruct the patients to report any unusual changes of the operated site to their physician. Surgeon should immediately evaluate the patient if a change at the fracture site has been detected. The surgeon should evaluate the possibility of subsequent clinical failure, and discuss with the patient the need for reduced activity levels, and / or possible revision surgery in order to aid fracture healing.

The surgeon should discuss all physical and psychological limitations inherent in the use of external fracture fixation appliances with the patient. Particular attention should be given to premature weight bearing, activity levels and the necessity for periodic medical follow-up.

The surgeon must warn patients of surgical risks, and make them aware of possible adverse effects. The patient should be warned that the device cannot and does not replicate a normal healthy bone, that the device can break or become damaged as a result of strenuous activity or trauma.

The Hoffmann LRF System is MR Unsafe



Warnings

Single use devices cannot be reused, as they are not designed to perform as intended after the first usage. Changes in mechanical, physical or chemical characteristics introduced under conditions of repeated use, cleaning and re-sterilization may compromise the integrity of the design and/or materials leading to diminished safety, performance and/or compliance with relevant specifications. Please refer to the device label to identify single or multiple use and/or cleaning and re-sterilization release.

Introduction

The typical LRF construct features two or more rings bridged by three to four telescopic struts with multiplanar, ball jointed fixation bolts. Once applied, the LRF can be unlocked for gross frame adjustment and fracture reduction. The LRF can be finely adjusted to aid in limb alignment and definitively locked to hold compression and reduction.

If deemed appropriate, the LRF Telescopic Struts can provide up to 5mm of controlled dynamization.

Compatibility

The Hoffmann LRF is mechanically compatible with Hoffmann II, Hoffmann II MRI and Hoffmann 3 Modular Fixation.

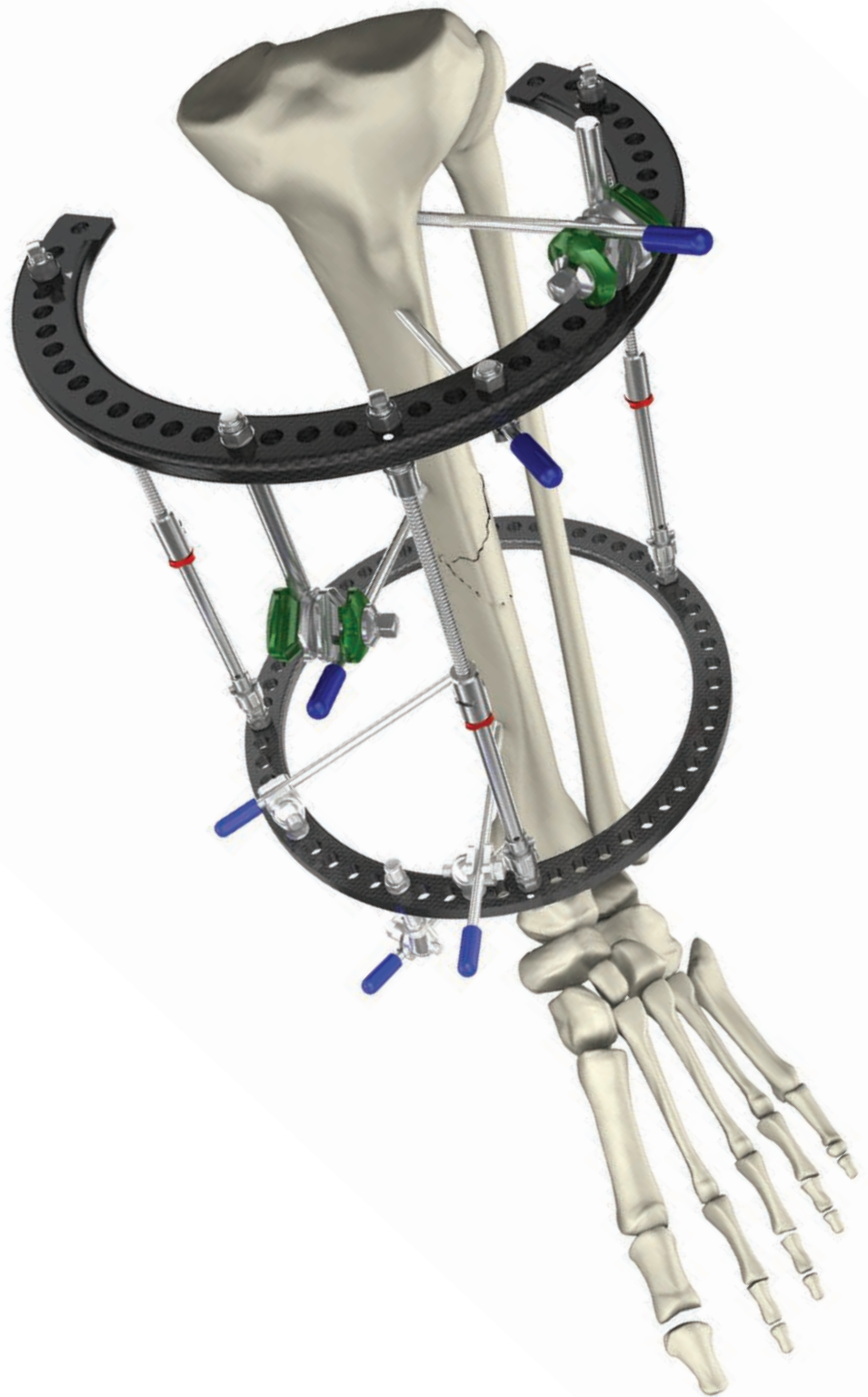

Key
components

Key components

Rings

- Available in aluminum and radiolucent carbon fiber reinforced polymer
- Full, open, segment, and short and long foot ring options

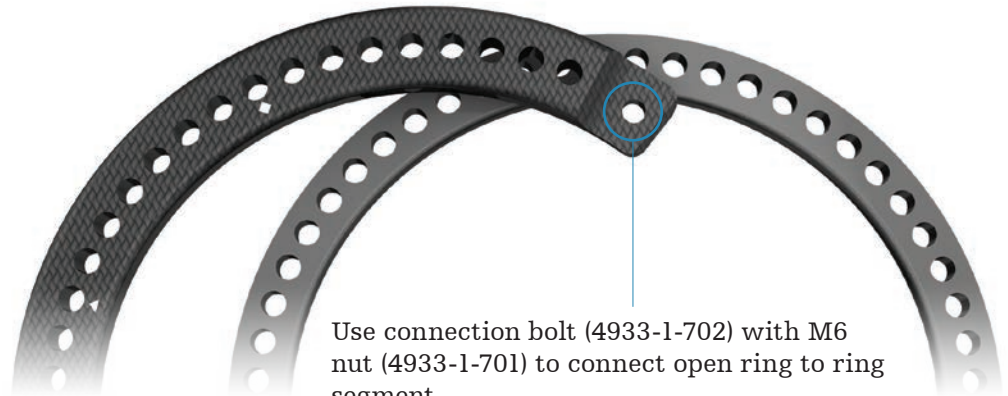

Note:

- ◆ Indicates suggested placement location when four struts are used in construct
- ▲ Indicates suggested placement location when three struts are used in construct

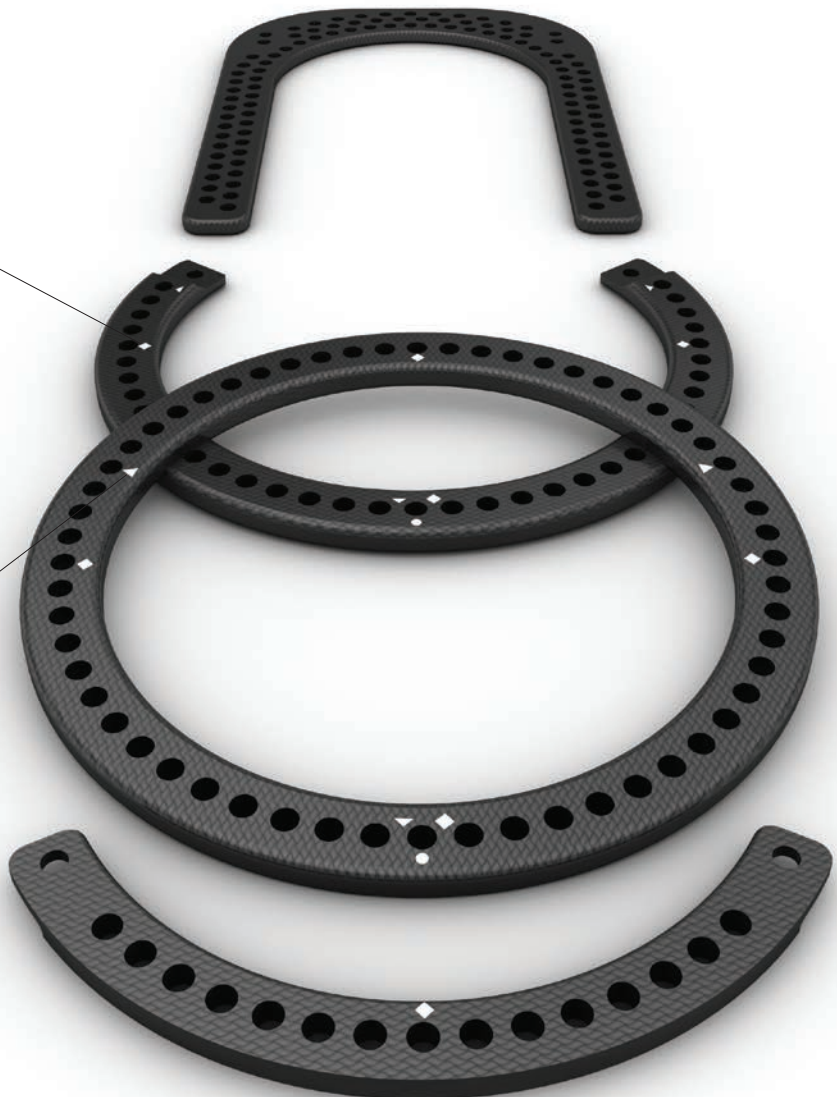

Key components

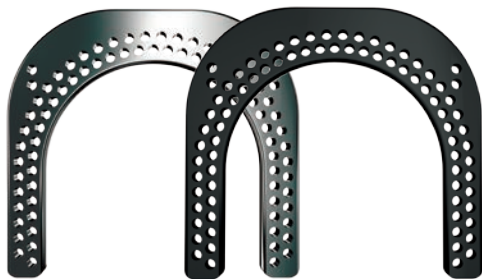
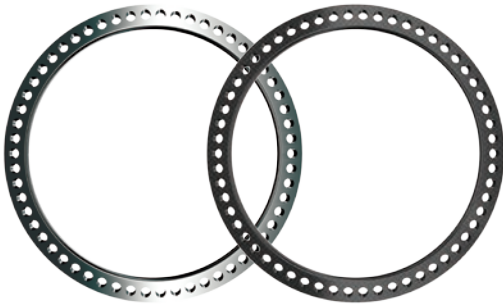

Ring types

Diameter

Full ring (Aluminum)
 Ø80mm
 Ø100mm
 Ø120mm
 Ø140mm
 Ø155mm
 Ø180mm
 Ø210mm
 Ø240mm
 Ø270mm

Diameter

Full ring (Carbon)
 Ø80mm
 Ø100mm
 Ø120mm
 Ø140mm
 Ø155mm
 Ø180mm
 Ø210mm

Diameter

Open ring (Aluminum)
 Ø100mm
 Ø120mm
 Ø140mm
 Ø155mm
 Ø180mm
 Ø210mm
 Ø240mm

Diameter

Open ring (Carbon)
 Ø100mm
 Ø120mm
 Ø140mm
 Ø155mm
 Ø180mm
 Ø210mm

Diameter

Ring segment (Aluminum)
 Ø100mm
 Ø120mm
 Ø140mm
 Ø155mm
 Ø180mm
 Ø210mm
 Ø240mm

Diameter

Ring segment (Carbon)
 Ø100mm
 Ø120mm
 Ø140mm
 Ø155mm
 Ø180mm
 Ø210mm

Diameter

Foot ring, long (Aluminum)
 Ø100mm
 Ø120mm
 Ø140mm
 Ø155mm
 Ø180mm
 Ø210mm

Diameter

Foot ring, long (Carbon)
 Ø100mm
 Ø120mm
 Ø140mm
 Ø155mm
 Ø180mm
 Ø210mm

Diameter

Foot ring, short (Aluminum)
 Ø100mm
 Ø120mm
 Ø140mm
 Ø155mm
 Ø180mm
 Ø210mm

Diameter

Foot ring, short (Carbon)
 Ø100mm
 Ø120mm
 Ø140mm
 Ø155mm
 Ø180mm
 Ø210mm

Caution:
 To maintain intended performance,
 carbon fiber rings should not be re-sterilized
 beyond (50) autoclave cycles.

Key components

Foot arches

- Radiolucent carbon fiber reinforced polymer
- Fully assembled design with built-in hinged connection bolts allow for angular adjustment
- Provides weight-bearing support when linked to tibial ring
- Available in 100, 120, 140, 155, 180 and 210mm diameters



Foot arches are attached to rings using the M8 connection nuts (4933-1-010).

To ensure easy application, assemble foot arches on rings prior to tensioning wires.

If both rocker shoes and foot arches are used, take caution not to occupy the holes required for rocker shoe attachment

Caution:

To maintain intended performance, carbon fiber foot arches should not be re-sterilized beyond (50) autoclave cycles.



Key components

Rocker shoes

- Independent shoe design allows side-specific height adjustment to compensate for angled distal foot ring
- Anterior and posterior shoe ends feature a 15° slope
- Treaded rubber sole helps improve traction during ambulation
- Available in 6 sizes
- Dedicated posterior Rocker Shoe mounting holes



Note:
Rocker shoes are not offered sterile and must be applied post-operatively.

Caution:
Use caution when walking on wet or slippery surfaces.

Note:
Rocker shoes are attached to rings using the M6 connection nuts (4933-1-701)

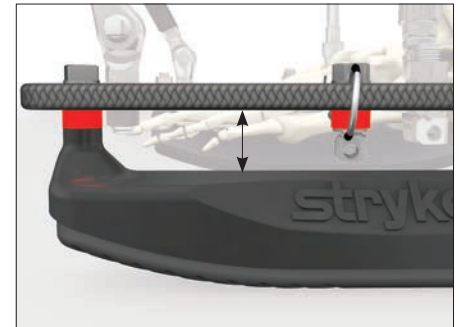
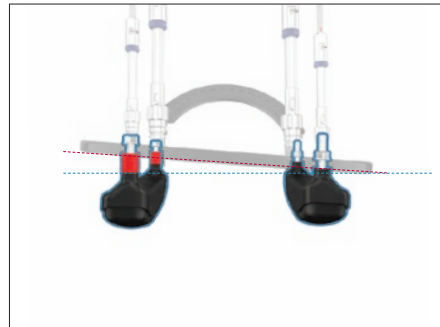



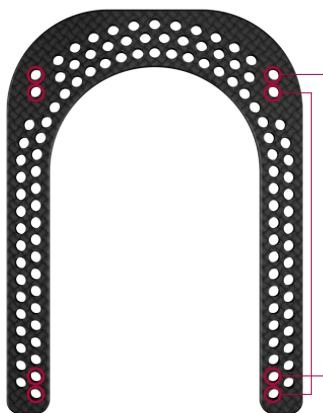





Max Clearance = 23mm
(incl. Washer Red 7mm)



Note:
If rocker shoes are indicated, do not occupy dedicated mounting holes with other frame components.

On open end of the foot ring, rocker shoes mount on inner row of holes.

Rocker shoe sizing

Left foot rings	Dia (mm)	Long rocker shoe size	
	100	Small rocker shoe long (4934-8-100)	
	120		
	140	Medium rocker shoe long (4934-8-140)	
	155		
	180	Large rocker shoe long (4934-8-180)	
210			
Short foot rings	Dia (mm)	Short rocker shoe size	
	100	Small rocker shoe long (4934-7-100)	
	120		
	140	Medium rocker shoe long (4934-7-140)	
	155		
	180	Large rocker shoe long (4934-7-180)	
210			

Key components

Wire bolt

- Built-in grooved stainless steel washer
- Cannulated wire bolt head reduces overall component weight and accepts counter-torque wire bolt Wrench for one-handed tightening
- Accepts 1.5, 1.8, & 2.0mm wires
- Available in short, medium and long sizes
- Chamfer on wire bolt head indicates slot location

Note:

Use only medium and long wire bolts when inserted directly into carbon fiber rings.

Wire bolt adaptor

- Used in conjunction with wire bolts to capture obliquely inserted wires or wires placed above or below ring surface
- Available in long and short versions



Note:

Wire bolts and wire bolt adaptors are attached to rings using the M8 connecting nuts (4933-1-010).

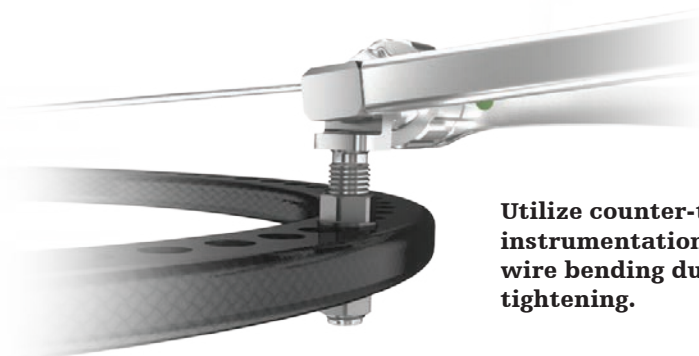
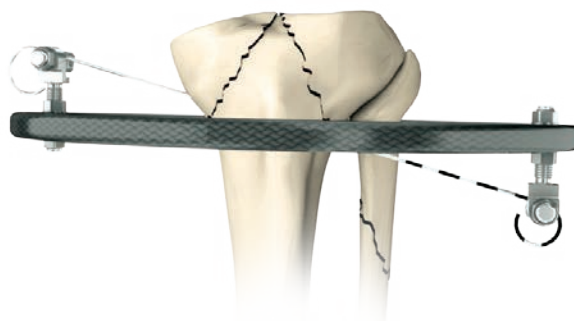
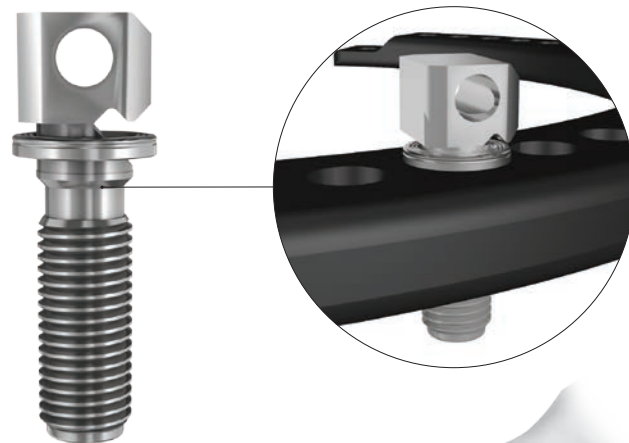

Utilize counter-torque instrumentation to minimize wire bending during final tightening.

Key components

Apex pin adaptor

- Available in long and short versions
- One-piece design compatible with 3/4/5/6mm apex pins
- Adjustable for multiplanar fixation options

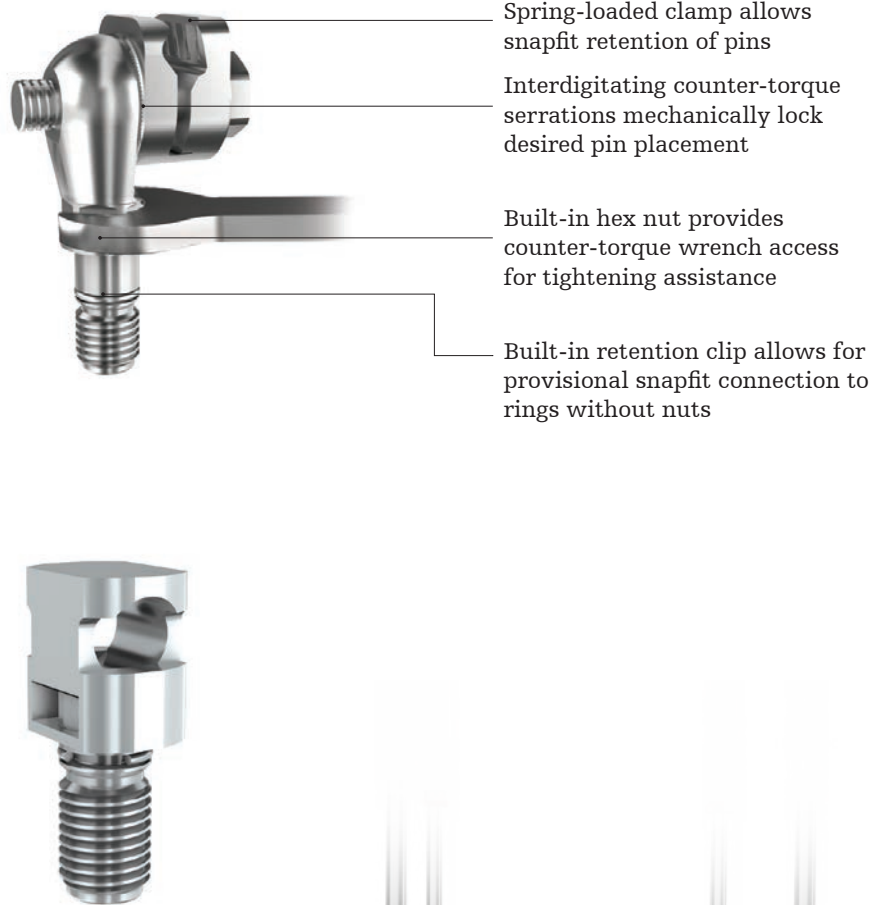

Apex pin bolt

- One-piece design compatible with 3/4/5/6mm apex pins
- Designed to connect apex pins directly parallel to ring

Caution:

Apex pin adaptors and apex pin bolts should only be provisionally tightened around the soft tissue protection sleeve with thumbwheel. If spanner wrenches are used, the sleeve may deform if overtightened.

Note:

Apex pin adaptors and apex pin bolts are attached to rings using the M8 connecting nuts (4933-1-010).

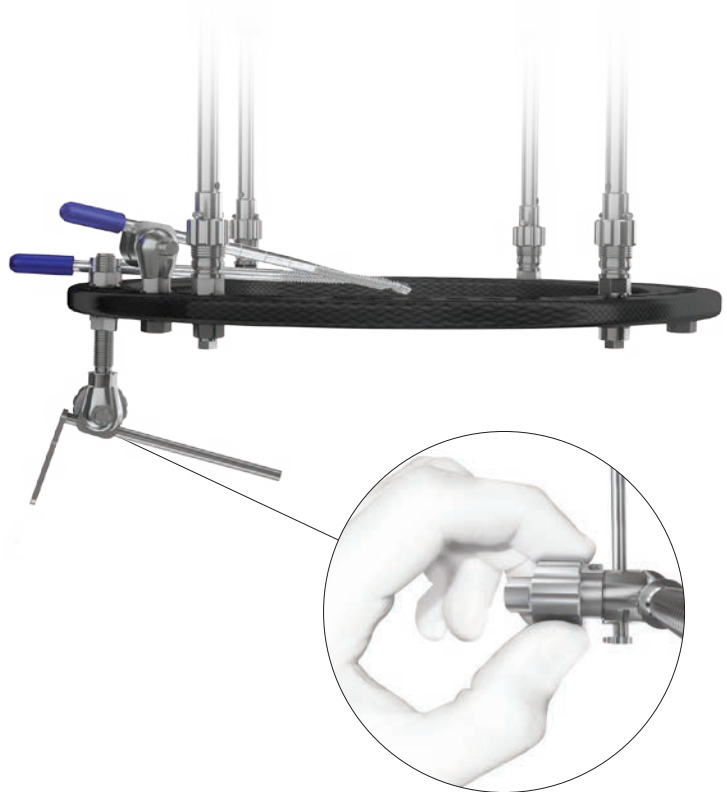

Key components

Connecting nut (M8)

- Built-in washer provides more surface area to contact ring
- Long connecting nut available for wrench access when components are placed side by side on rings

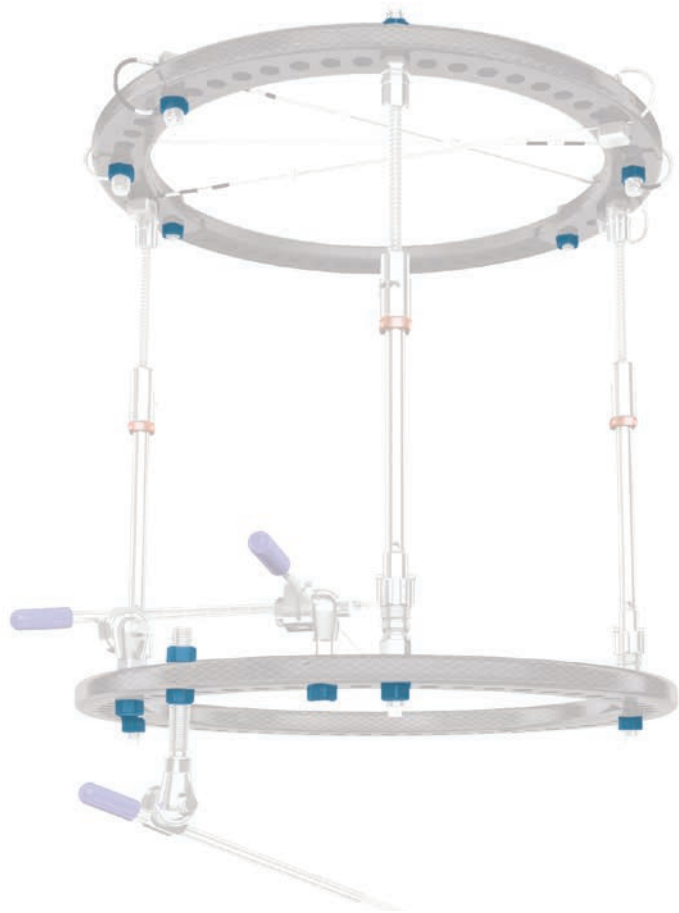

Key components

Telescopic struts

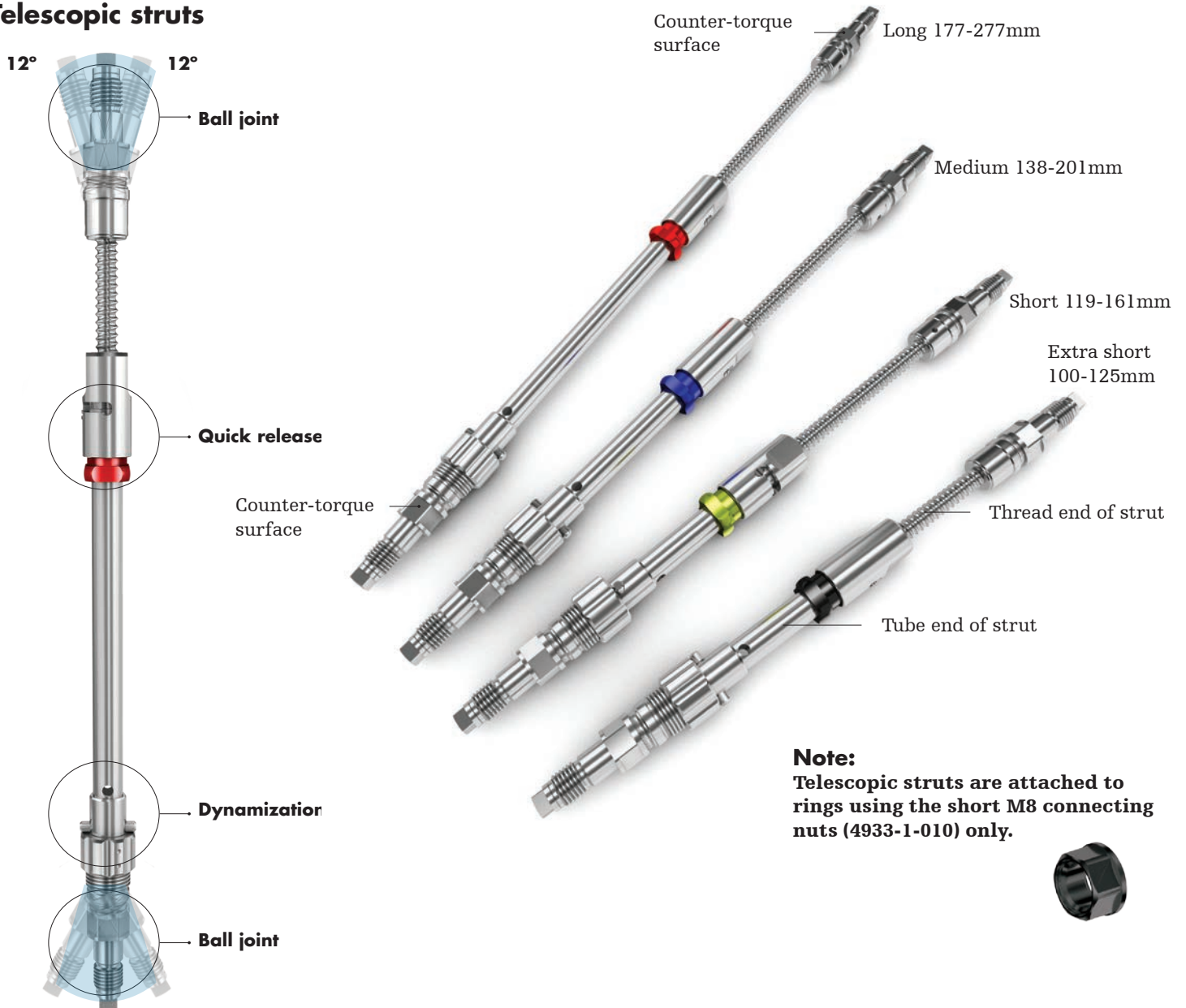

Telescopic strut cleaning

- Completely unscrew colored safety nut
- Flush quick release mechanism with water
- After cleaning, lubricate the threads of the colored safety nut and screw the colored safety nut back up to the groove



Key components

Telescopic struts: fracture reduction

Once mounted, the LRF can be unlocked and used as a fracture reduction tool. Once proper gross alignment is achieved, fine tuning can ensue followed by final locking. In addition to the quick release mechanisms, all ball joints must be unlocked to achieve full range of motion.



Key components

Telescopic struts: gross length adjustment

The length of the telescopic strut can be easily adjusted to fit between 2 rings when building the frame. Gross length adjustment may also be useful during fracture reduction.

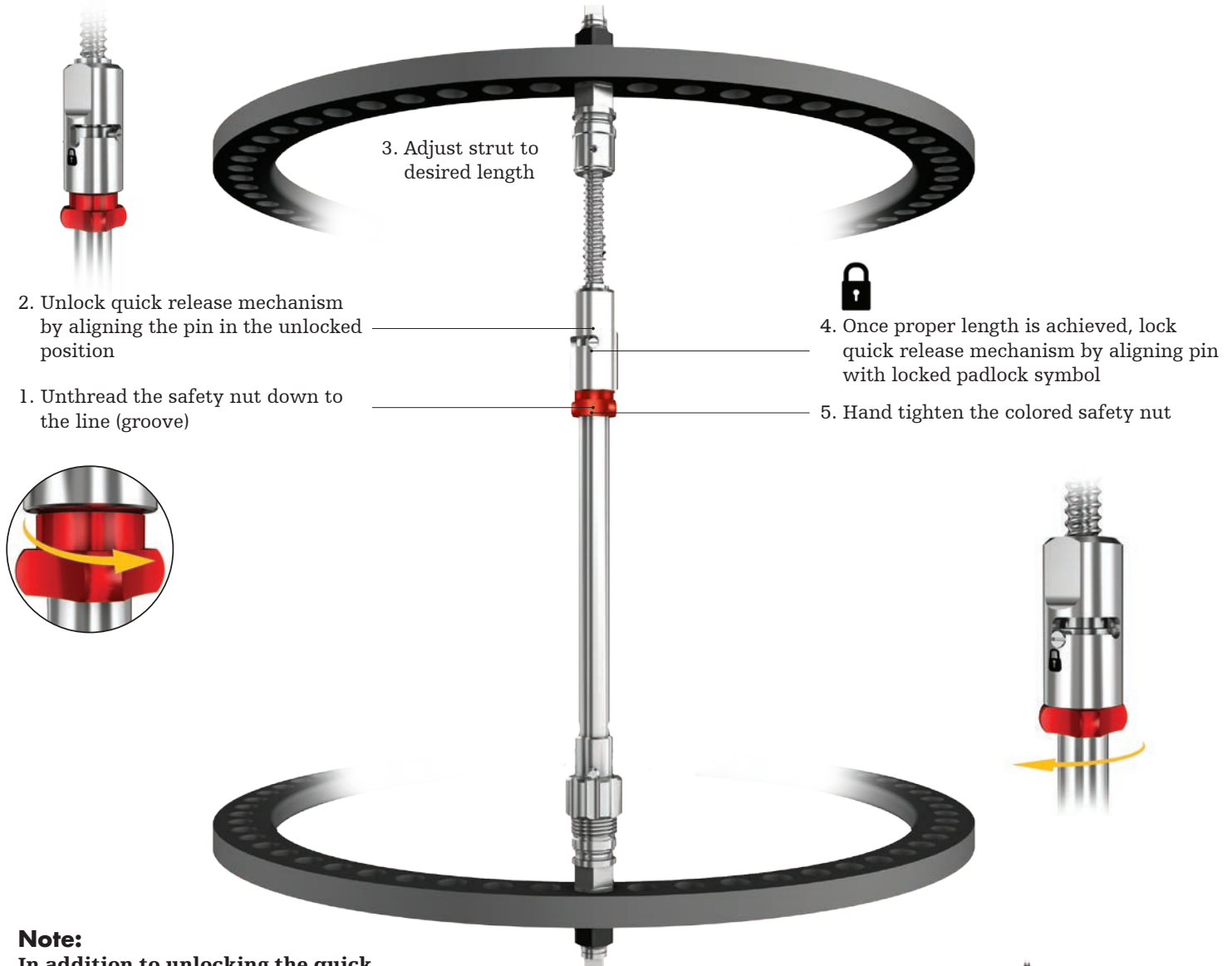

Note:
In addition to unlocking the quick release mechanisms, unlocking the ball joints may ease gross length adjustment.

Caution:
Flat surfaces on quick release mechanisms are for finger grip adjustments only. Using a wrench to swivel quick release mechanism may damage the strut.

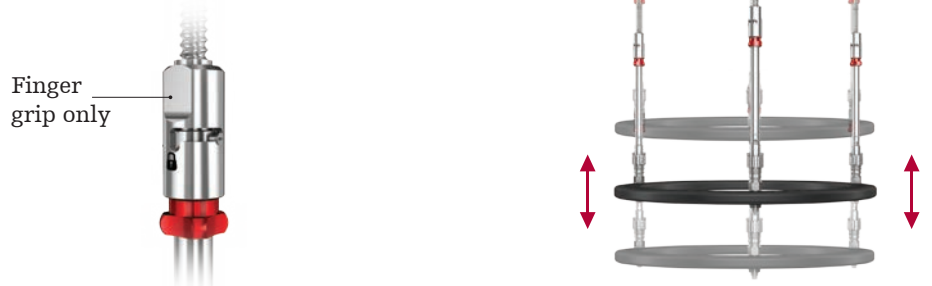

Key components

Telescopic struts: fine tuning length adjustments

The length of the telescopic struts can be fine-tuned once the frame is assembled. This feature allows the clinician to apply distraction or compression to the construct at any time during the course of the treatment.

Note:

The clinician must ensure that compression of the device using the fine tuning mechanism does not destabilize the fracture pattern.

2. Tighten ball joint on threaded end of strut

- 
1. Lock quick release mechanism by aligning the pin in the locked padlock position

4. Wrench (4933-9-207) fits on pin to adjust length
 - + Distraction
 - Compression
 - Each full turn distracts or compresses by 2mm

3. Loosen ball joint at tube end of strut

Threaded end of strut

Tube end of strut

Fine tuning length adjustment

5. Tighten ball joint tube end

Caution:

Only loosen square drive enough to make adjustments. Forcing the square drive too loose may damage strut.

Key components

Telescopic struts: ball joint adjustments

The ball joints at both ends of the telescopic strut make it possible to connect rings that are not parallel or are of different diameters. They also can help with reducing bone fractures.

1. The ball joints are unlocked at both ends of strut by loosening the square drive with the yellow 5mm wrench driver (4940-9-030) or the 5mm spanner wrench (4933-9-205)



Prior to frame assembly, the clinician has the option to realign the ball joint to straight position using the thumbwheel for telescopic struts (4933-9-208), yellow teardrop 5mm wrench (4940-9-030), and 4933-9-202 ratchet wrench for counter-torque as shown.



Ball joints allow for 12° of freedom from neutral



Using M8 nuts, each strut is connected to the rings

2. Frame can be manipulated to reduce fracture or adjust alignment

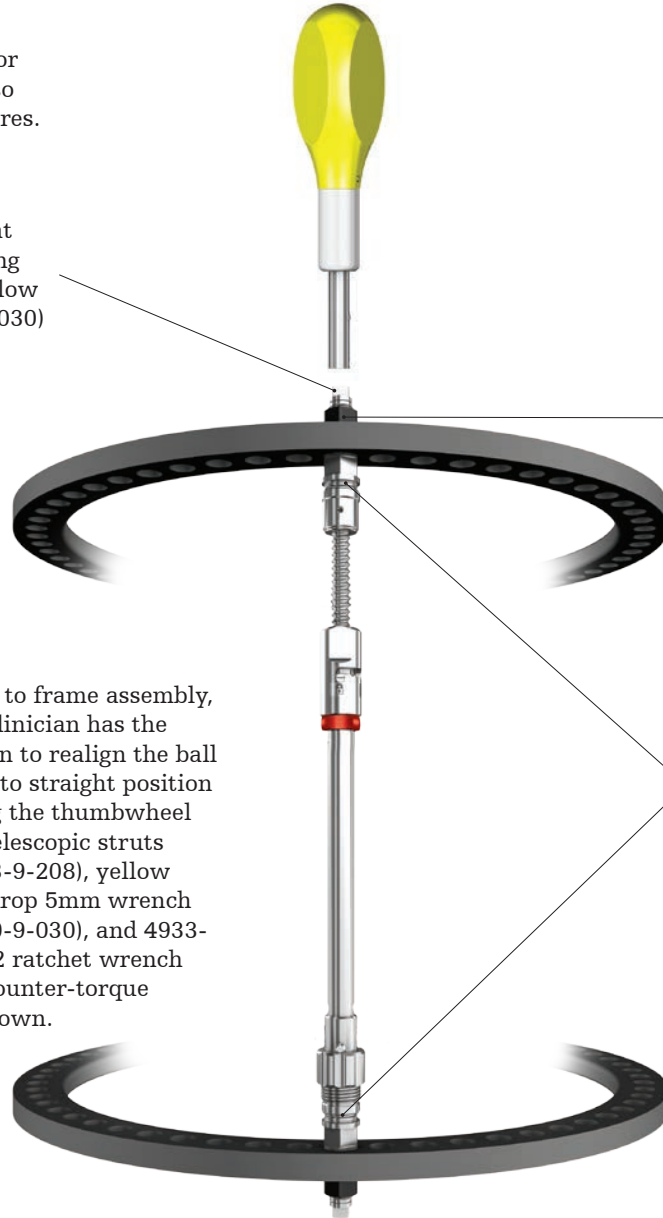

3. Once frame is satisfactorily adjusted, ball joints at both ends of strut are locked by tightening the 5mm square drive



Key components

Telescopic struts: dynamization

Dynamization may be initiated post-operatively during early stages of bone healing and after early callus formation as assessed radiographically. Struts can be gradually dynamized as determined by the clinician. Dynamization is achieved by turning the dynamization wheel on the telescopic strut using wrench (4933-9-207).

Each line on the strut corresponds to one additional millimeter of dynamization. While using dynamization, patients should exercise extra caution when engaging in extraneous physical activities. A maximum of 5mm of dynamization may be achieved with these struts.

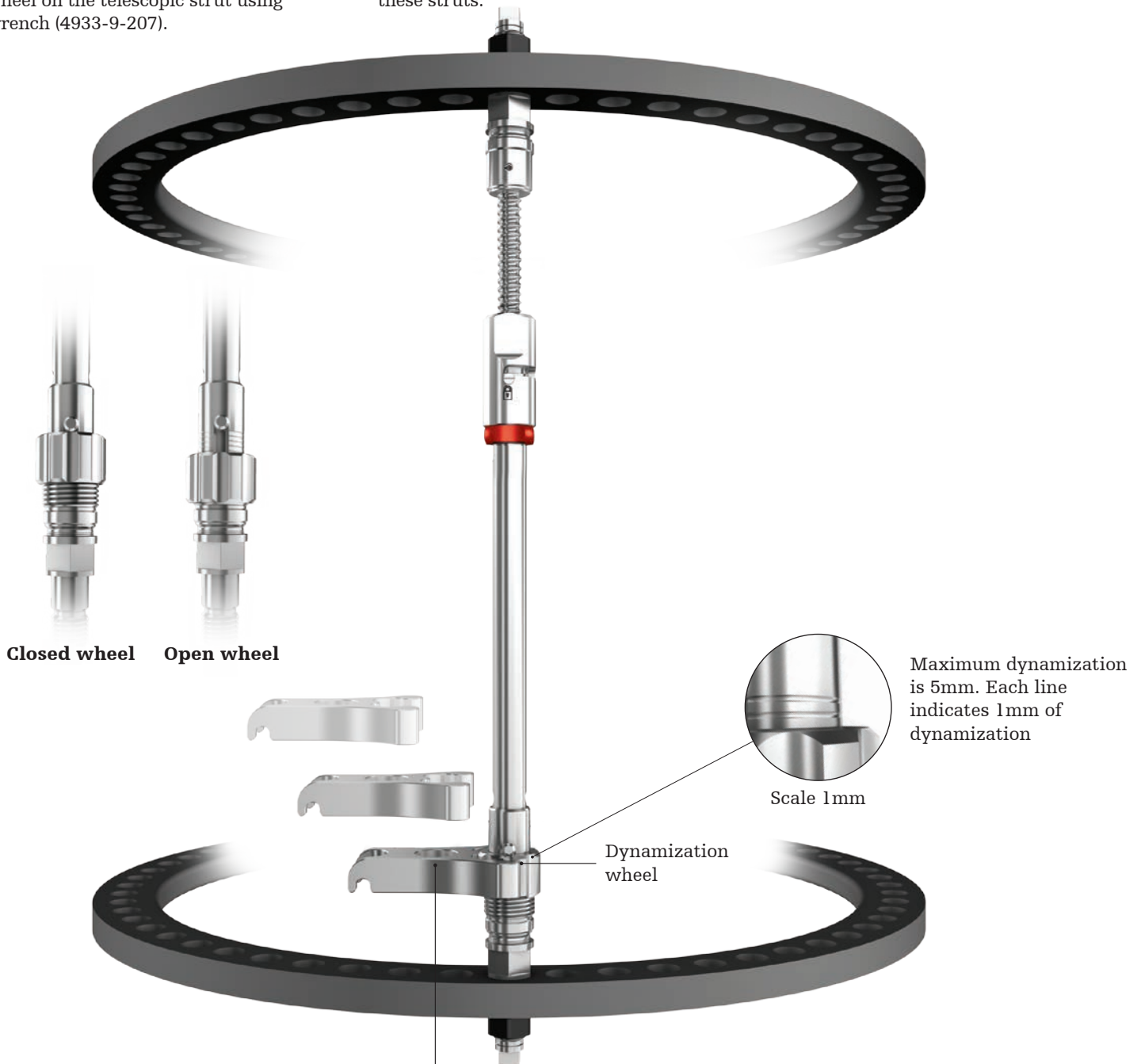









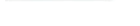

Use open end on telescopic strut wrench (4933-9-207) on wheel (not on pin) to adjust dynamization

Key components

Threaded rods

The Hoffmann LRF System includes threaded rods in the following sizes*:

- 6mm x 30mm 
- 6mm x 60mm 
- 6mm x 80mm 
- 6mm x 100mm 
- 6mm x 120mm 
- 6mm x 150mm 
- 6mm x 200mm 
- 6mm x 250mm 
- 6mm x 300mm 
- 6mm x 350mm 
- 6mm x 400mm 

LRF threaded rods are attached to rings using the ring/threaded rod connecting M6 nut 4933-1-701.

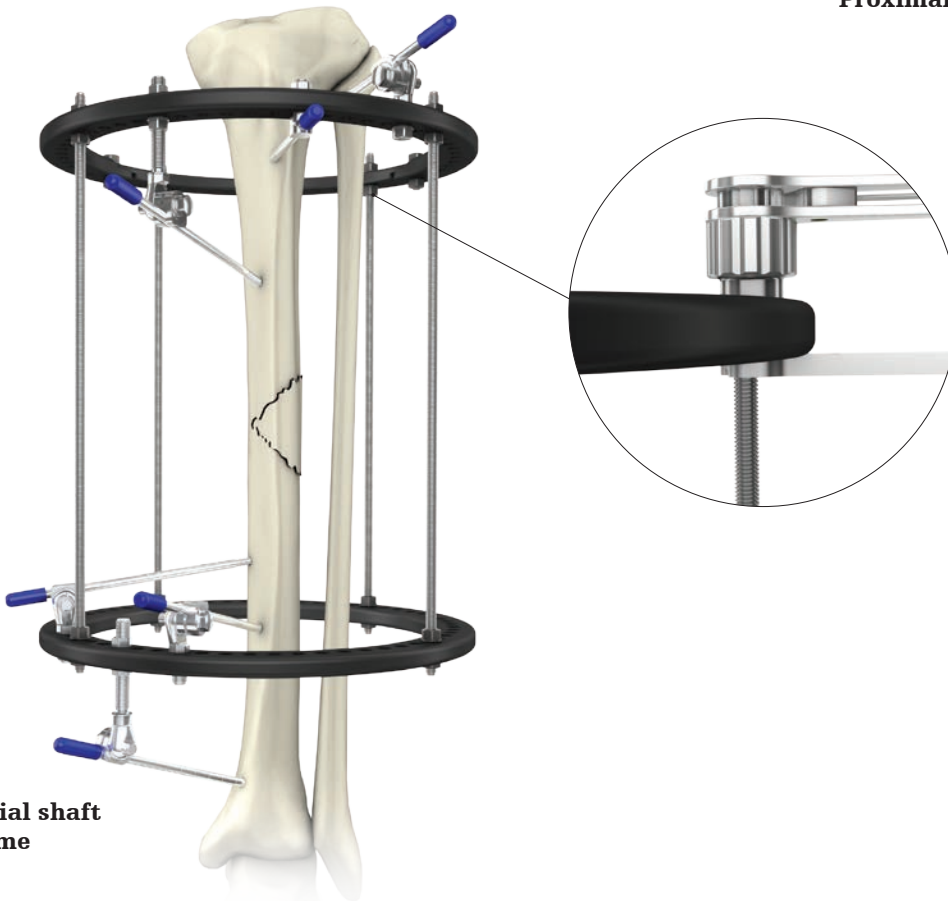
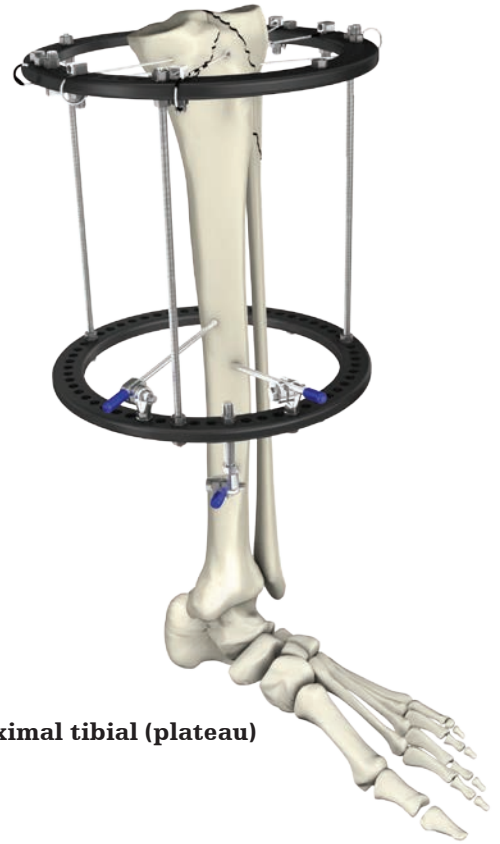

* Optional rod cutter (5057-6-300) not included in set.

Key components

Hinge couplings

- The LRF hinge couplings can be connected to threaded rods to create a wide range of simple hinged assemblies
- Pre-assembled hinge coupling can be locked for static frame applications
- Constrained, offering motion in a single plane

Frame example: hinge coupling used to reinforce foot and ankle frame by connecting foot arch to tibial ring

Caution:

It is recommended that hinge couplings are reinforced with M6 connecting nuts when attaching to threaded rods.

Note:

Hinge couplings are attached to rings using ring connection bolt (4933-1-702).

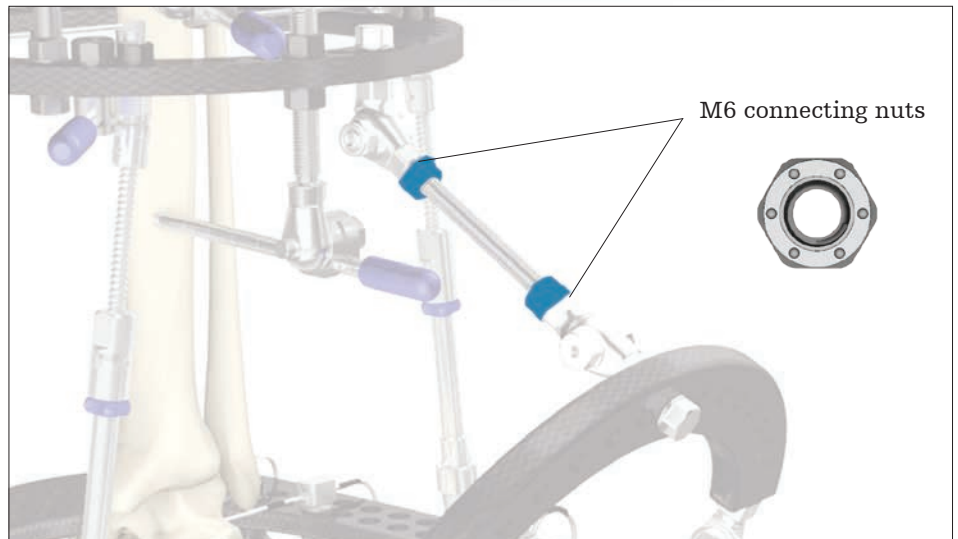

Note:

When building a static connection between tibial ring and foot arch, confirm that self-locking nuts on hinge couplings are locked tight.



Key components

Static struts

The Hoffmann LRF System includes static struts that can be used to stack rings. The static struts are available in the following sizes:

- Extra short 20mm 
- Short 30mm 
- Medium 40mm 
- Long 60mm 

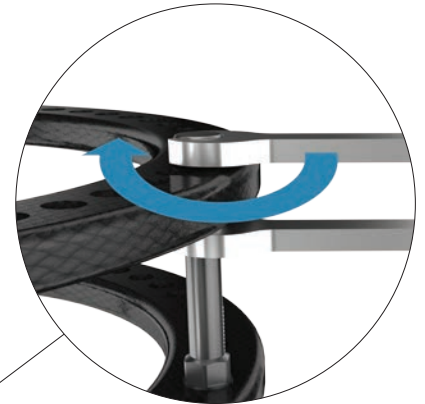

Static struts are connected to rings using connection bolt (4933-1-702)



Ø8mm static struts designed to accommodate Hoffmann II and Hoffmann 3 couplings for additional fixation options

Key instruments

Fixation components wrenches



Wire bolt wrench (4933-9-201)
with built-in counter-torque for
tightening wire bolts

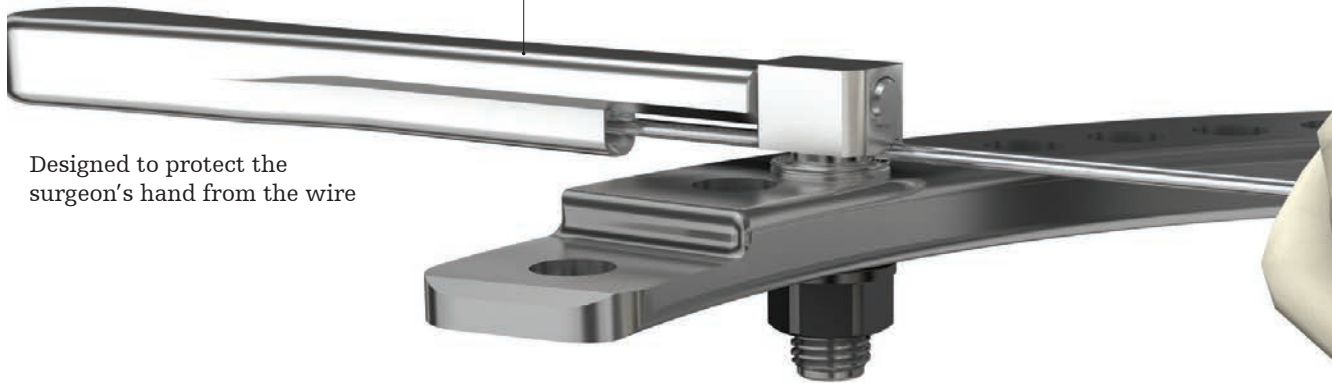

Designed to protect the
surgeon's hand from the wire



Thumbwheel for ratchet wrench
(4933-9-203) for provisional tightening.
Can be used in conjunction with
ratchet wrench.



Ratchet wrench (4933-9-202)
for quick bolt tightening.
Flip over for loosening or tightening.



Note:
Ratchet and wire bolt wrench may
be used in a one-handed procedure.

Key instruments

Wire tensioner

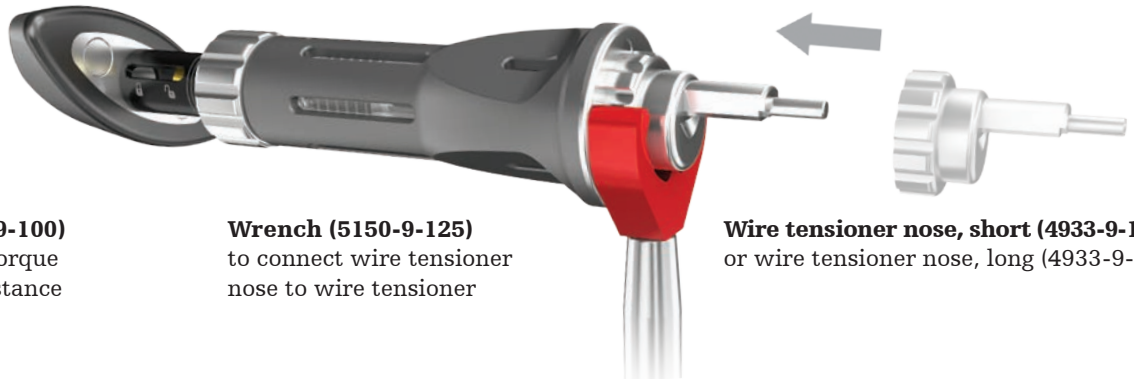

Wire tensioner (4933-9-100)
with modular counter-torque
nose for tightening assistance

Wrench (5150-9-125)
to connect wire tensioner
nose to wire tensioner

Wire tensioner nose, short (4933-9-110)
or wire tensioner nose, long (4933-9-111)

Before introducing wire into tensioner, ensure that gold indicator is on open padlock side (counterclockwise turn of black handle)

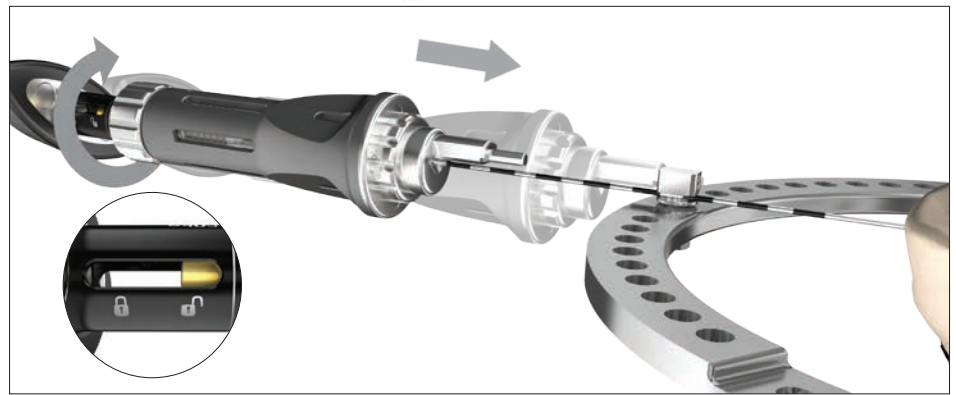

Turn black handle clockwise to tension wire to the desired level. There are three rings on the shaft of the black handle corresponding to 50kg, 90kg, and 130kg. When the ring submerges into the barrel, the wire has been tensioned to the corresponding level. Once appropriate tension level is achieved, connecting nut is tightened with the appropriate wrench.

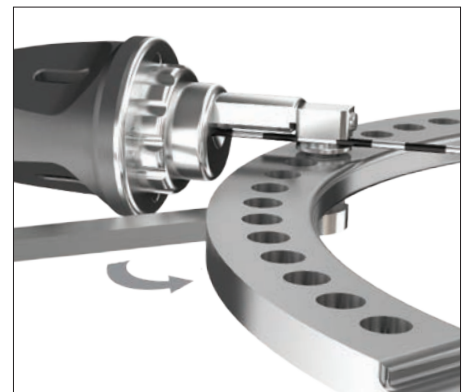

Once wire-bolt is definitively tightened on wire, the tensioner is removed off the wire by rotating the black handle counterclockwise until the gold indicator is in the open padlock position.

Note:

Do not trim excess wire until tensioning is complete. If the tensioner does not bite the wire during tensioning, repeat the procedure: Turn black tensioner handle counterclockwise until gold indicator is in the open padlock position. Proceed with clockwise turns to engage wire until tensioned to desired level.

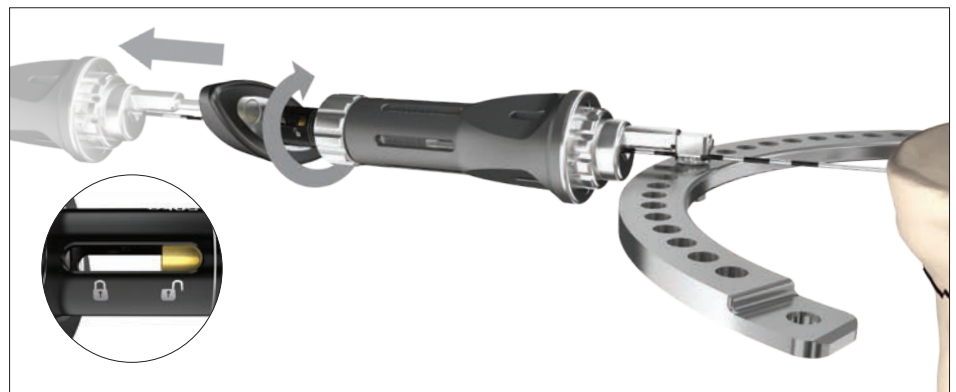

Key instruments

Recommended tension levels

50kg Tension



- Wire bolt offset adaptor, long (4933-1-005) used with wire bolt short (4933-1-001)

90kg Tension



- Wire bolt offset adaptor, short (4933-1-005) used with wire bolt short (4933-1-001)
- Wires used on foot rings

130kg Tension



- Wire bolt, short (4933-1-001)
- Wire bolt, medium (4933-1-002)
- Wire bolt, long (4933-1-003)

Wire tensioner disassembly / assembly & lubrication



Align yellow indicator with unlocked padlock symbol



Using wrench (5150-9-125) remove wire tensioner nose



Using wrench (5150-9-125) remove wire tensioner wheel



After removing the inner cylinder from the tensioner barrel, apply lubrication to moving parts. Lubrication should be performed before sterilization at least after every 5 surgeries



Align pin and groove to reintroduce the inner cylinder to the tensioner barrel



Using wrench (5150-9-125) attach wire tensioner wheel

Operative technique

Operative technique

Sleeve system

1. When templating apex pin placement off of rings, identify proper hole and introduce apex pin bolt.

Note:

Apex pin bolts and apex pin adaptors are attached to rings with M8 connecting nuts.

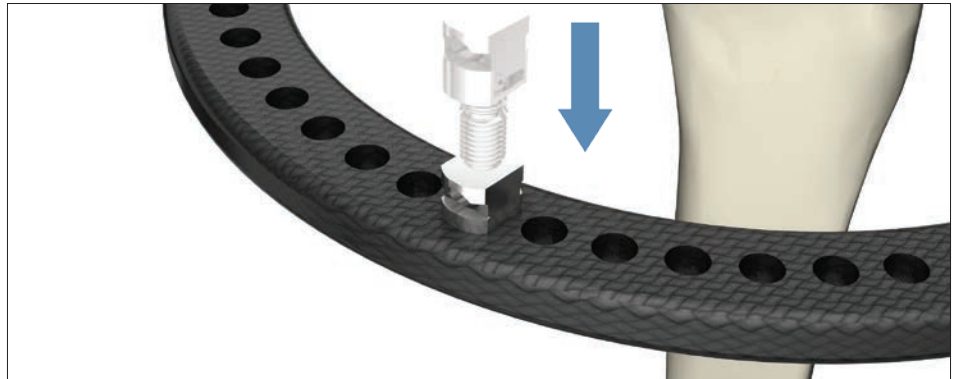

2. Select the sleeve assembly that corresponds to the diameter apex pin being inserted and introduce into the apex pin bolt.

Caution:

The sleeve assemblies include sizes to accommodate 3, 4, 5, and 6mm apex pins.

Do not overtighten pin bolt around sleeve assembly as this may deform the soft tissue sleeve. Utilize thumbwheels to provisionally capture sleeve assembly in pin bolt.

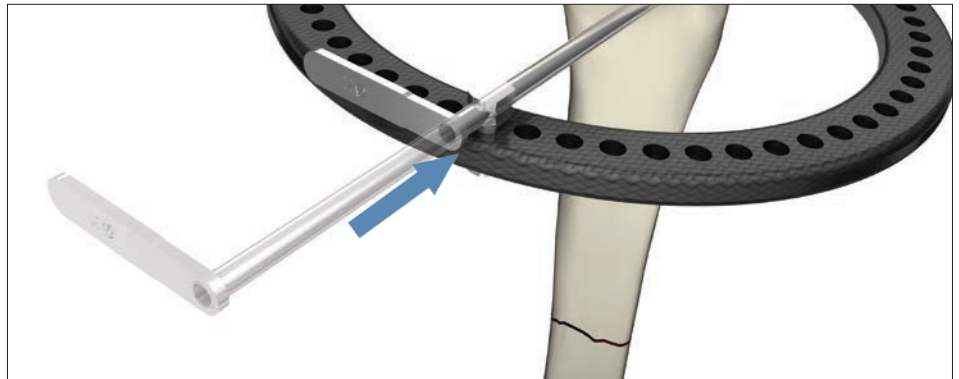

3. Impact trocar to create dimple in cortical wall. If self-drilling apex pins are used, the trocar is removed and the appropriately sized apex pin inserted through the soft tissue sleeve.

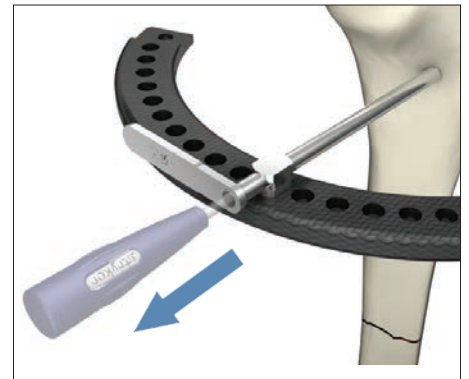
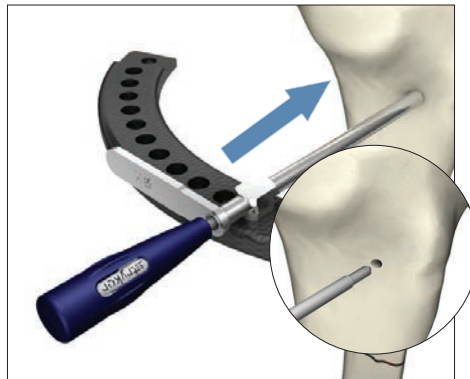

4. When using blunt apex pins, pre-drilling is necessary. After impacting and removing trocar, introduce drill sleeve into soft tissue sleeve in preparation for drilling.

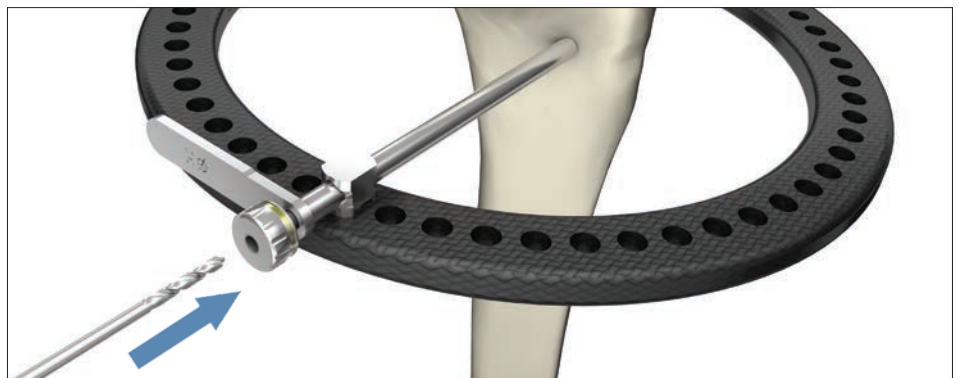

Operative technique

Sleeve system

5. Drill to desired depth and remove drill and drill sleeve from the soft tissue sleeve.

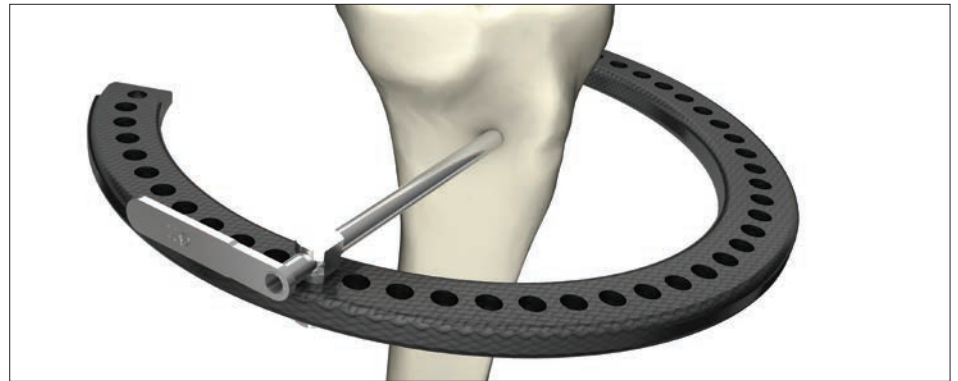
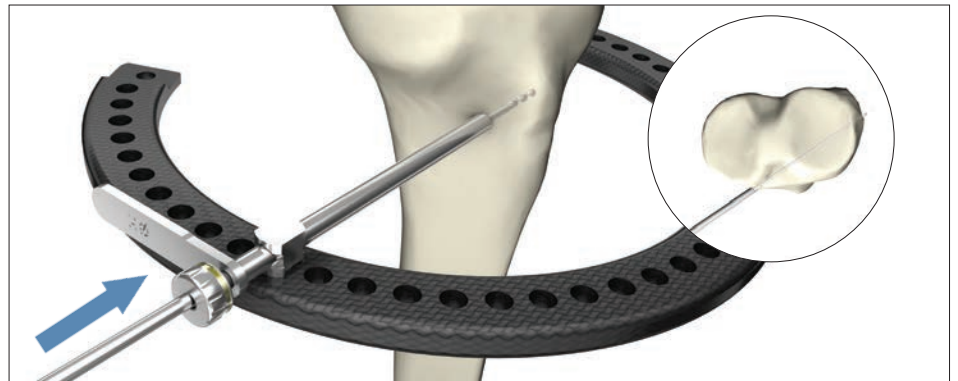

6. Insert apex pin through soft tissue sleeve and advance to the desired position.

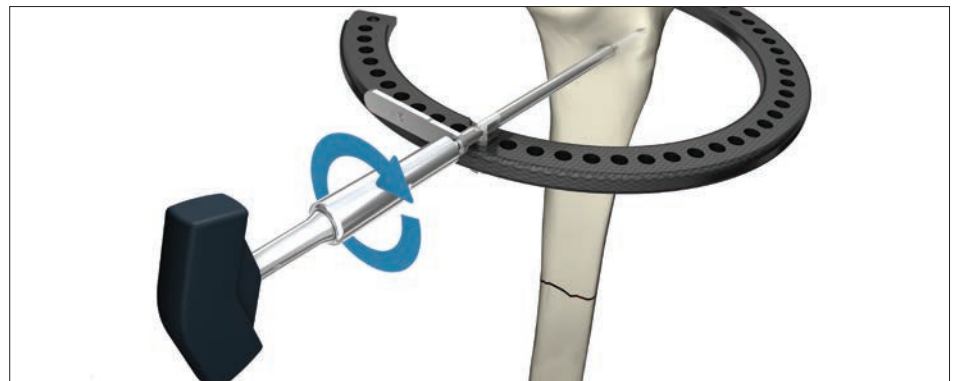

7. Once proper apex pin placement is achieved, loosen connection nut on apex pin bolt and remove the soft tissue sleeve.

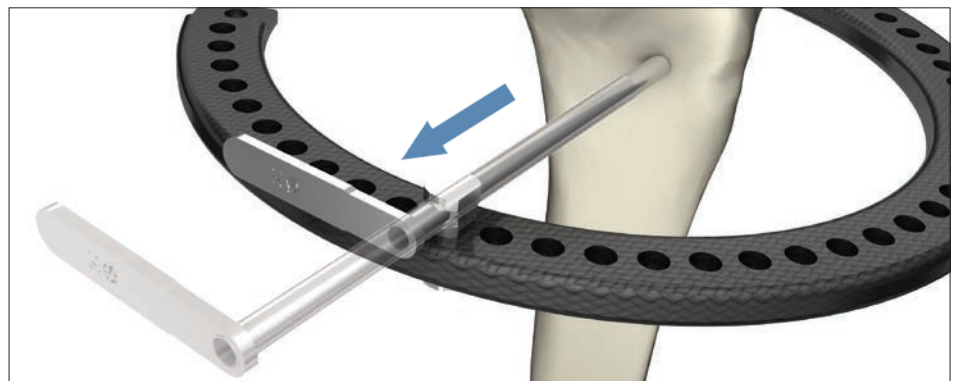

Operative technique

Sleeve system

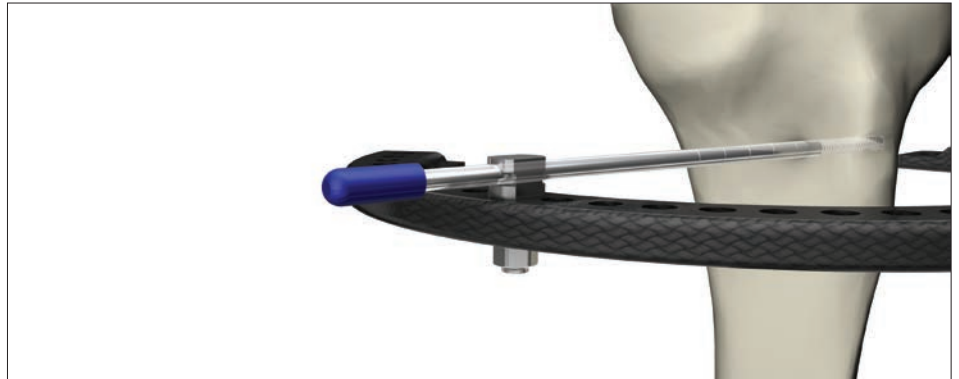

8. Utilize counter-torque instrumentation to minimize pin bolt rotation during final tightening.

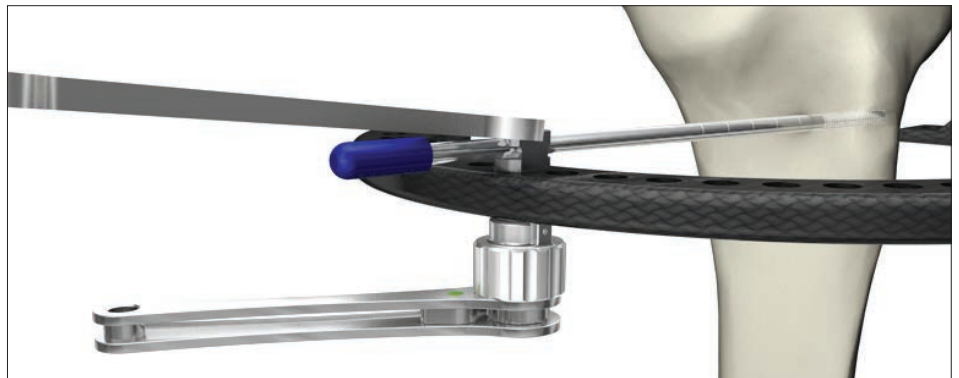

Frame examples

Frame examples

Static foot & ankle frame example

It is recommended to insert a minimum of 3 points of fixation per circular ring and a minimum of 4 points of fixation per foot ring. If only wires are used on a fixation block then 4 wires are recommended. A minimum of 4 struts is recommended for this application.

Warning:

To ensure sufficient construct stability, it is recommended that the tibial ring and foot arch are reinforced with supplemental fixation. Shown: distal tibial ring and foot arch bridged with hinged couplings and threaded rod. In certain incidences, supplemental

fixation should be considered (i.e. obese patients or patients that are ambulatory in the early postoperative phase). Construct design and weight bearing protocols are always to the surgeon's discretion.



Caution:

Confirm all nuts and connections are tightened upon completion of frame. Confirm all quick release mechanisms and ball joints on struts are in locked position.

The wires should be curled or cut short to prevent skin injury.

Frame examples

Static foot & ankle frame components

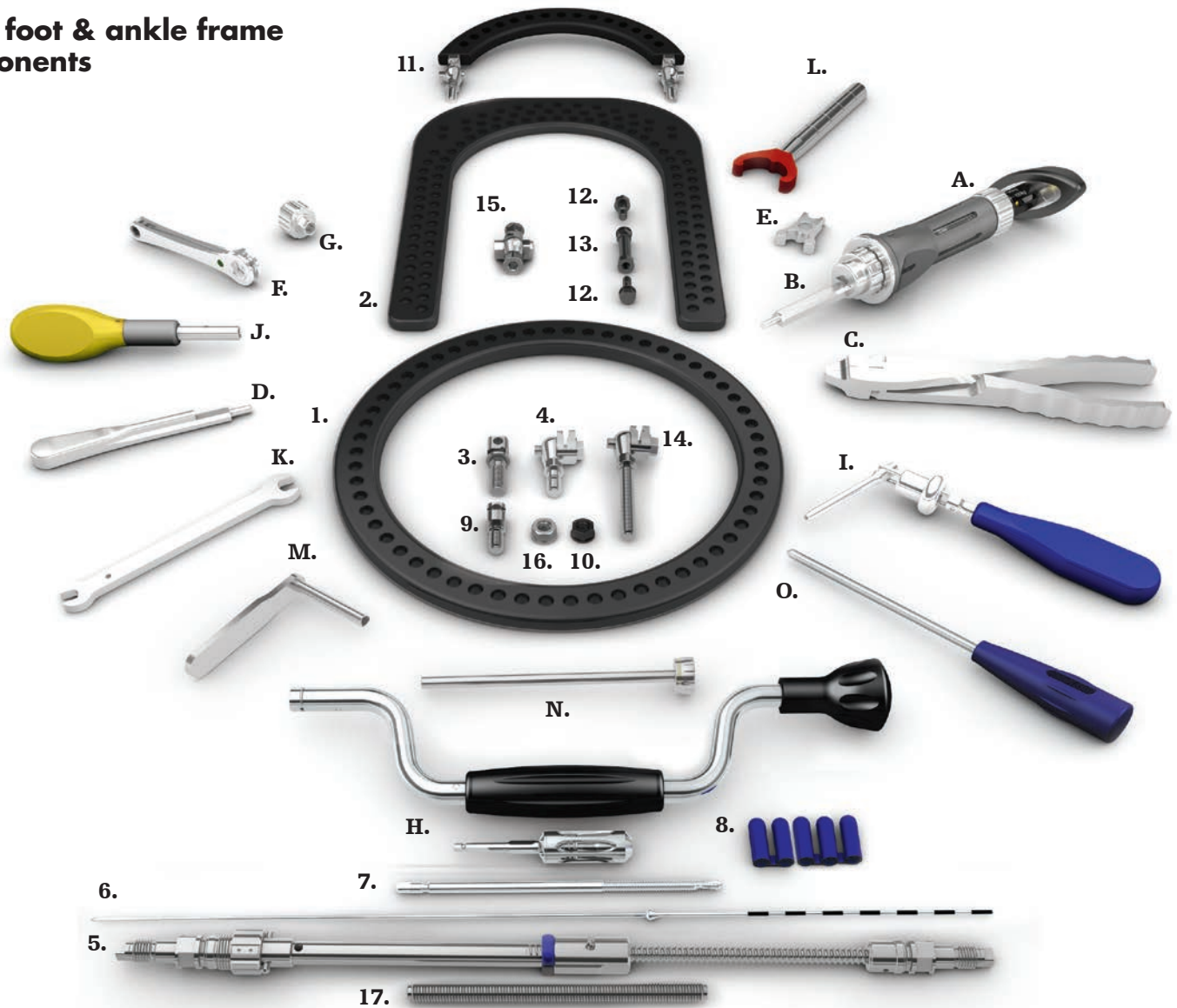

Components used

- | | | |
|--------------------------------|----------------------------|--------------------------------|
| 1. 2 x Full ring | 7. 6 x Apex half pin | 13. 4 x Static strut |
| 2. 1 x Foot ring, long | 8. 6 x End cap | 14. 1 x Apex pin adaptor, long |
| 3. 10 x Wire bolt | 9. 3 x Apex pin bolt, Ø3-6 | 15. 2 x Hinge coupling |
| 4. 2 x Apex pin adaptor, short | 10. 27 x M8 connecting nut | 16. 2 x M6 connecting nut |
| 5. 4 x Telescopic strut | 11. 1 x Foot arch | 17. 1 x Threaded rod |
| 6. 5 x Wire with olive | 12. 8 x Connecting bolt | |

Instruments used

- | | | |
|------------------------------------|-----------------------------------|--------------------------|
| A. Wire tensioner | F. Ratchet wrench | K. Spanner wrench 7/10mm |
| B. Wire tensioner nose, long | G. Thumbwheel for ratchet wrench | L. Wrench (red) |
| C. Wire cutting and bending pliers | H. Drill brace or universal chuck | M. Soft tissue sleeve |
| D. Wire bolt wrench | I. Split wire sleeve | N. Drill sleeve |
| E. Telescopic strut wrench | J. Pin driver | O. Trocar |

Frame examples

Tibial shaft frame example

It is recommended to insert a minimum of three fixation points per ring. Fixation points may be a combination of wires and/or pins. Fixation should be placed in a divergent fashion for increased stability. If only wires are used on a fixation block then 4 wires are recommended.

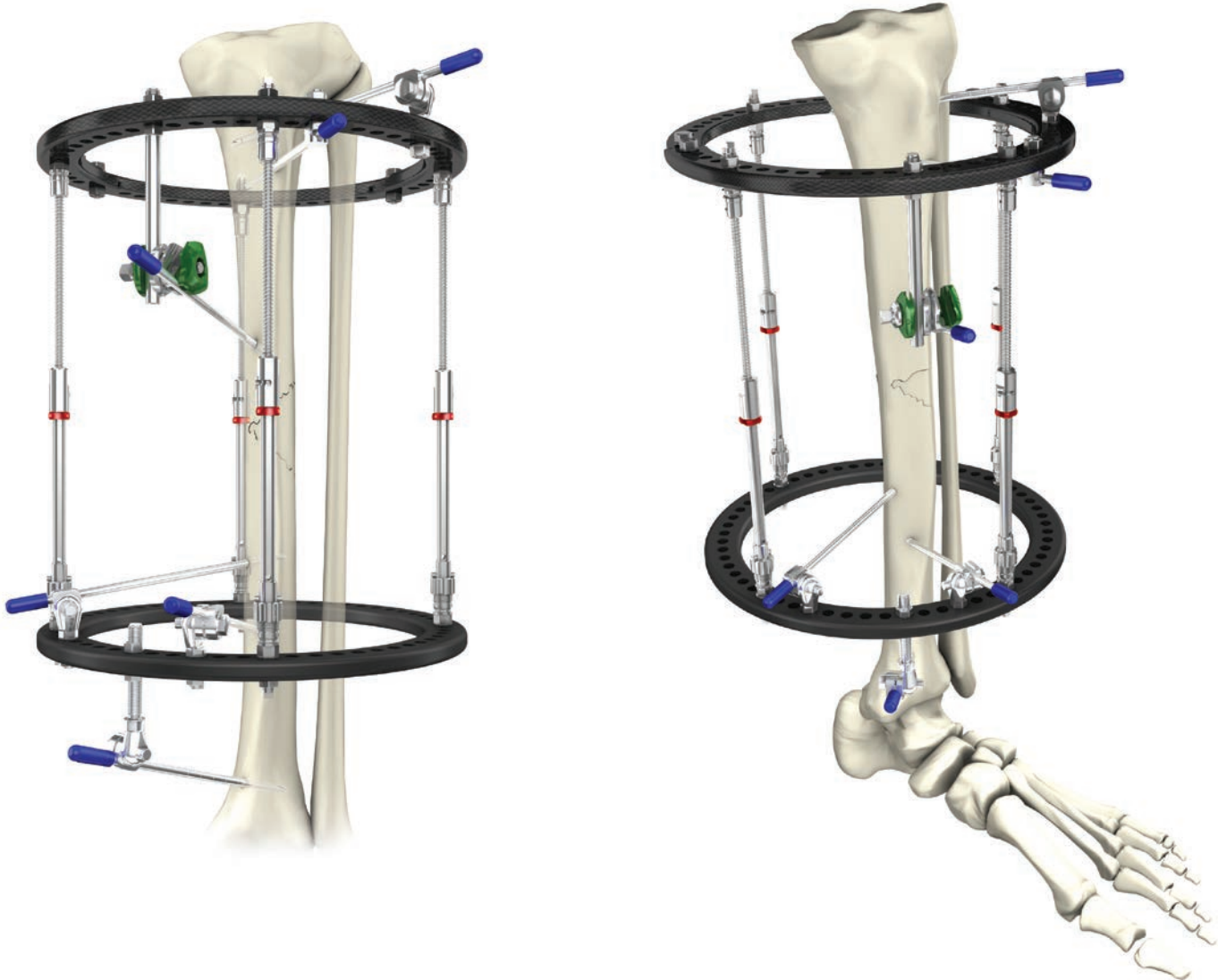

Caution:

Confirm all nuts and connections are tightened upon completion of frame. Confirm all quick release mechanisms and ball joints on struts are in locked position.

Frame examples

Tibial shaft frame components

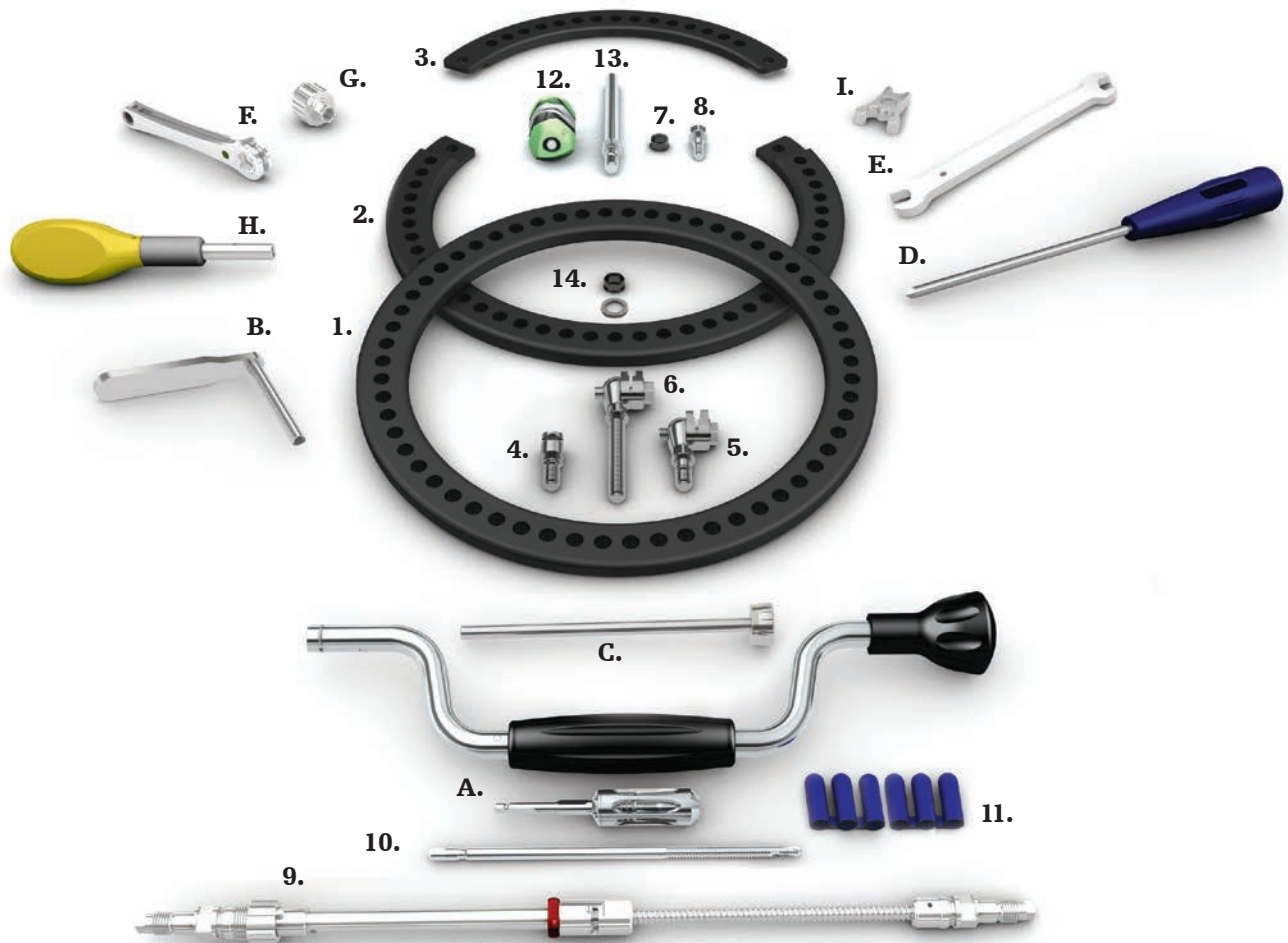

Components used

- | | | |
|--------------------------------|-----------------------------|----------------------------|
| 1. 1 x Full ring | 7. 2 x M6 connecting nut | 13. 1 x Post, long |
| 2. 1 x Open ring | 8. 2 x Ring connecting bolt | 14. 15 x M8 connecting nut |
| 3. 1 x Ring segment | 9. 4 x Telescopic strut | |
| 4. 1 x Apex pin bolt, Ø3-6 | 10. 6 x Apex pin | |
| 5. 3 x Apex pin adaptor, short | 11. 6 x End cap | |
| 6. 1 x Apex pin adaptor, long | 12. 2 x Hoffmann 3 coupling | |

Instruments used

- | | |
|-----------------------------------|----------------------------------|
| A. Drill brace or universal chuck | F. Ratchet wrench |
| B. Soft tissue sleeve | G. Thumbwheel for ratchet wrench |
| C. Drill sleeve | H. Pin driver |
| D. Trocar | I. Telescopic strut wrench |
| E. Spanner wrench 7/10mm | |

Frame examples

Proximal tibial (plateau) frame example

It is recommended to insert a minimum of three fixation points per ring. Fixation points may be a combination of wires and/or pins. Fixation should be placed in a divergent fashion for increased stability. If only wires are used on a fixation block then 4 wires are recommended.

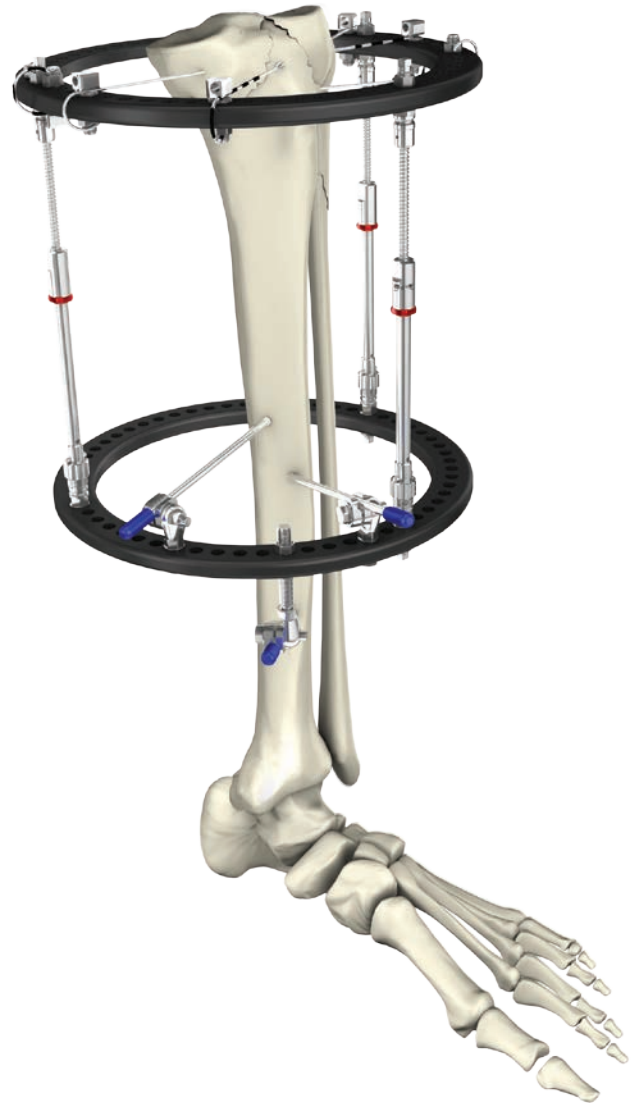

Caution:

Confirm all nuts and connections are tightened upon completion of frame. Confirm all quick release mechanisms and ball joints on struts are in locked position.

The wires should be curled or cut short to prevent skin injury.

Frame examples

Proximal tibial frame components

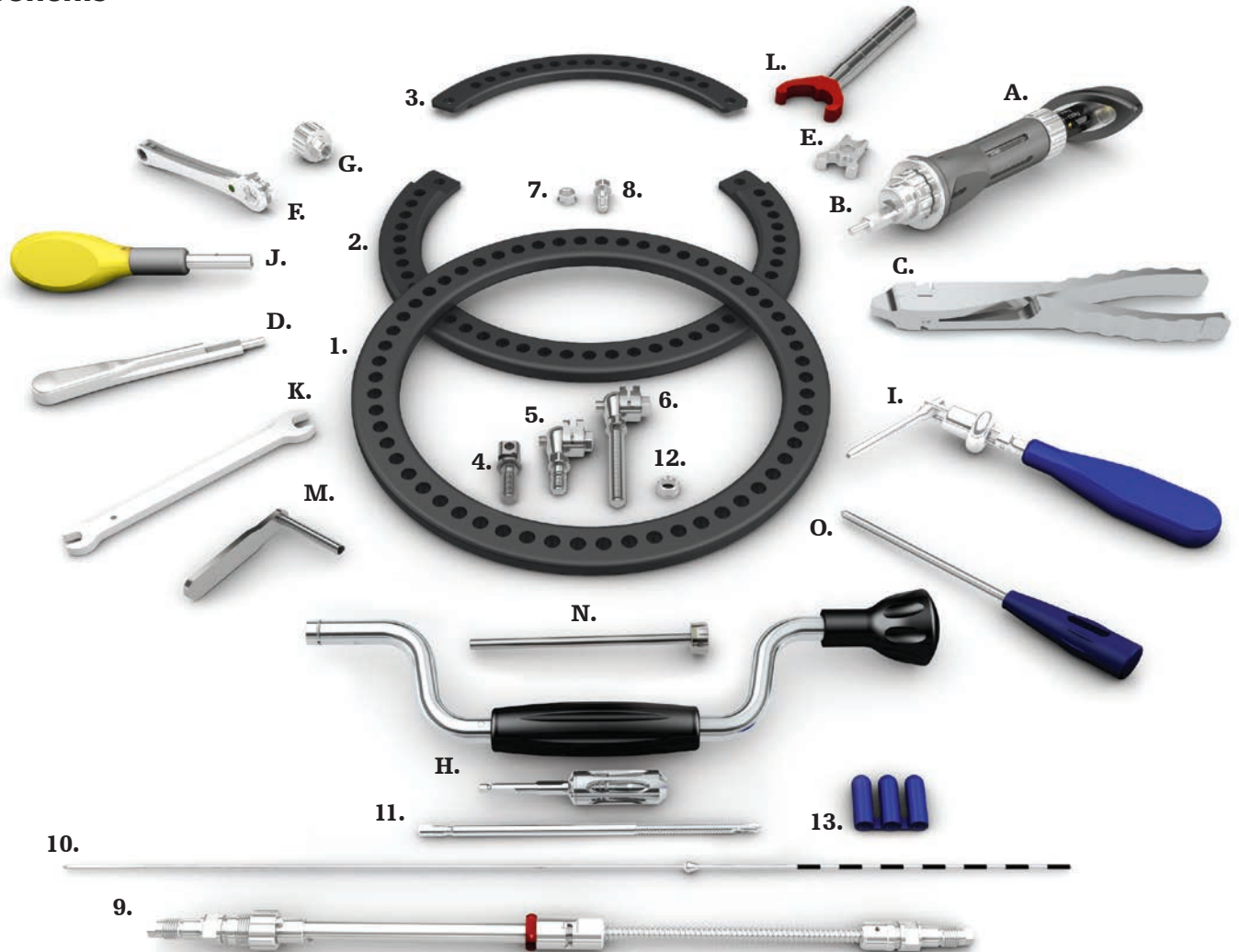

Components used

- | | | |
|--------------------------------|-------------------------------|----------------------------|
| 1. 1 x Full ring | 6. 1 x Apex pin adaptor, long | 11. 3 x Apex half pin |
| 2. 1 x Open ring | 7. 2 x M6 connecting nut | 12. 16 x M8 connecting nut |
| 3. 1 x Ring segment | 8. 2 x Connecting bolt | 13. 3 x End cap |
| 4. 6 x Wire bolt | 9. 3 x Telescopic strut | |
| 5. 2 x Apex pin adaptor, short | 10. 3 x Wire with olive | |

Instruments used

- | | | |
|------------------------------------|-----------------------------------|--------------------------|
| A. Wire tensioner | F. Ratchet wrench | K. Spanner wrench 7/10mm |
| B. Wire tensioner nose, short | G. Thumbwheel for ratchet wrench | L. Wrench (red) |
| C. Wire cutting and bending pliers | H. Drill brace or universal chuck | M. Soft tissue sleeve |
| D. Wire bolt wrench | I. Split wire sleeve | N. Drill sleeve |
| E. Telescopic strut wrench | J. Pin driver | O. Trocar |

Frame examples

Distal tibial frame example

It is recommended to insert a minimum of three fixation points per ring. Fixation points may be a combination of wires and/or pins. Fixation should be placed in a divergent fashion for increased stability. If only wires are used on a fixation block then 4 wires are recommended.

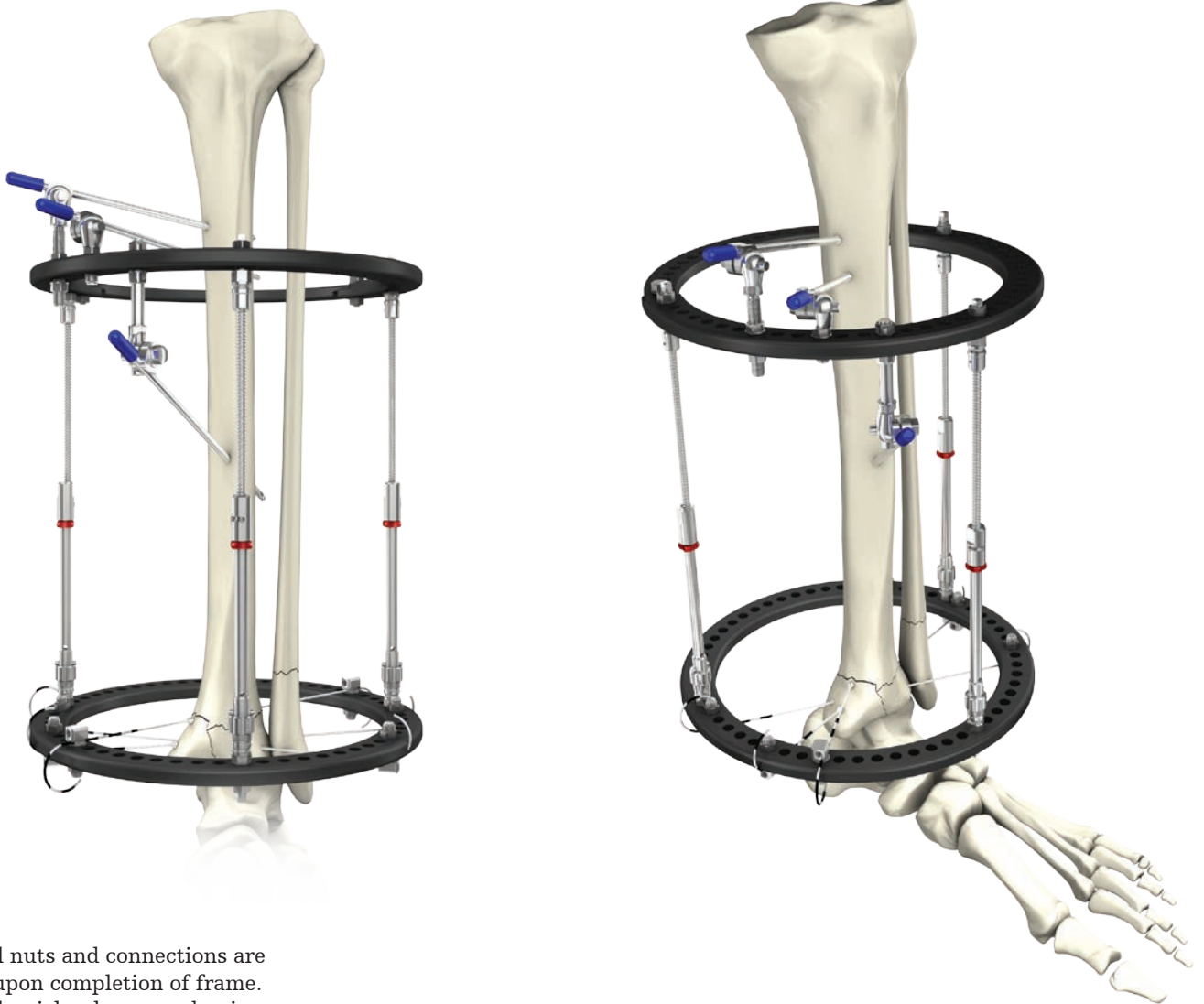

Caution:

Confirm all nuts and connections are tightened upon completion of frame. Confirm all quick release mechanisms and ball joints on struts are in locked position.

The wires should be curled or cut short to prevent skin injury.

Frame examples

Distal tibial frame components

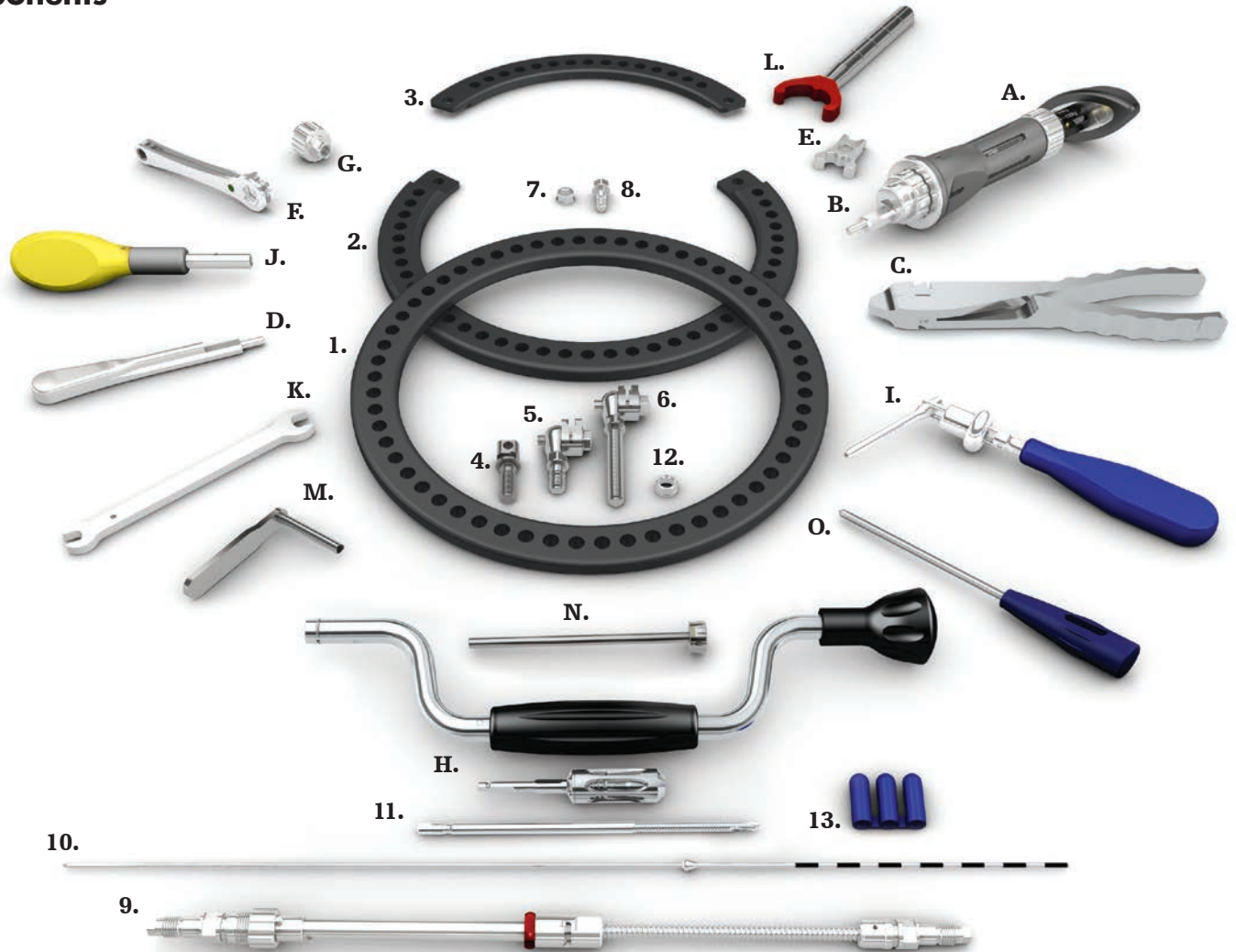

Components used

- | | | |
|--------------------------------|-------------------------------|----------------------------|
| 1. 1 x Full ring | 6. 1 x Apex pin adaptor, long | 11. 3 x Apex half pin |
| 2. 1 x Open ring | 7. 2 x M6 connecting nut | 12. 17 x M8 connecting nut |
| 3. 1 x Ring segment | 8. 2 x Connecting bolt | 13. 3 x End cap |
| 4. 6 x Wire bolt | 9. 3 x Telescopic strut | |
| 5. 1 x Apex pin adaptor, short | 10. 3 x Wire with olive | |

Instruments used

- | | | |
|------------------------------------|-----------------------------------|--------------------------|
| A. Wire tensioner | F. Ratchet wrench | K. Spanner wrench 7/10mm |
| B. Wire tensioner nose, short | G. Thumbwheel for ratchet wrench | L. Wrench (red) |
| C. Wire cutting and bending pliers | H. Drill brace or universal chuck | M. Soft tissue sleeve |
| D. Wire bolt wrench | I. Split wire sleeve | N. Drill sleeve |
| E. Telescopic strut wrench | J. Pin driver | O. Trocar |

Frame examples

Distal radius frame example

It is recommended to insert a minimum of two to three fixation points per ring. Fixation points may be a combination of wires and/or pins. Fixation should be placed in the radius in a divergent fashion for increased stability.

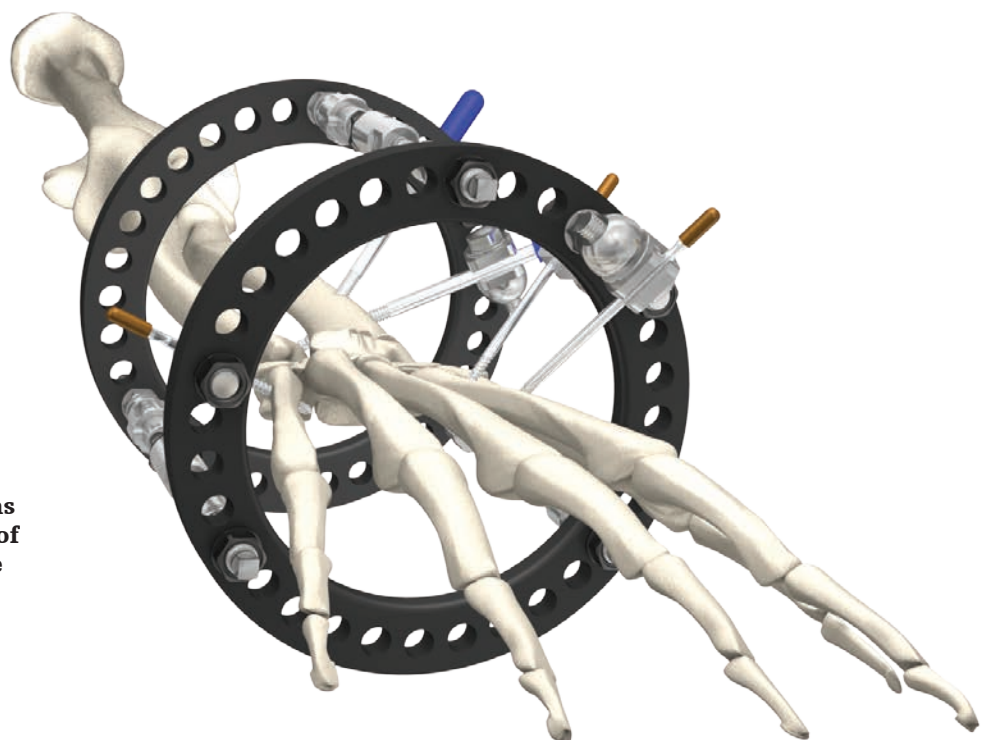
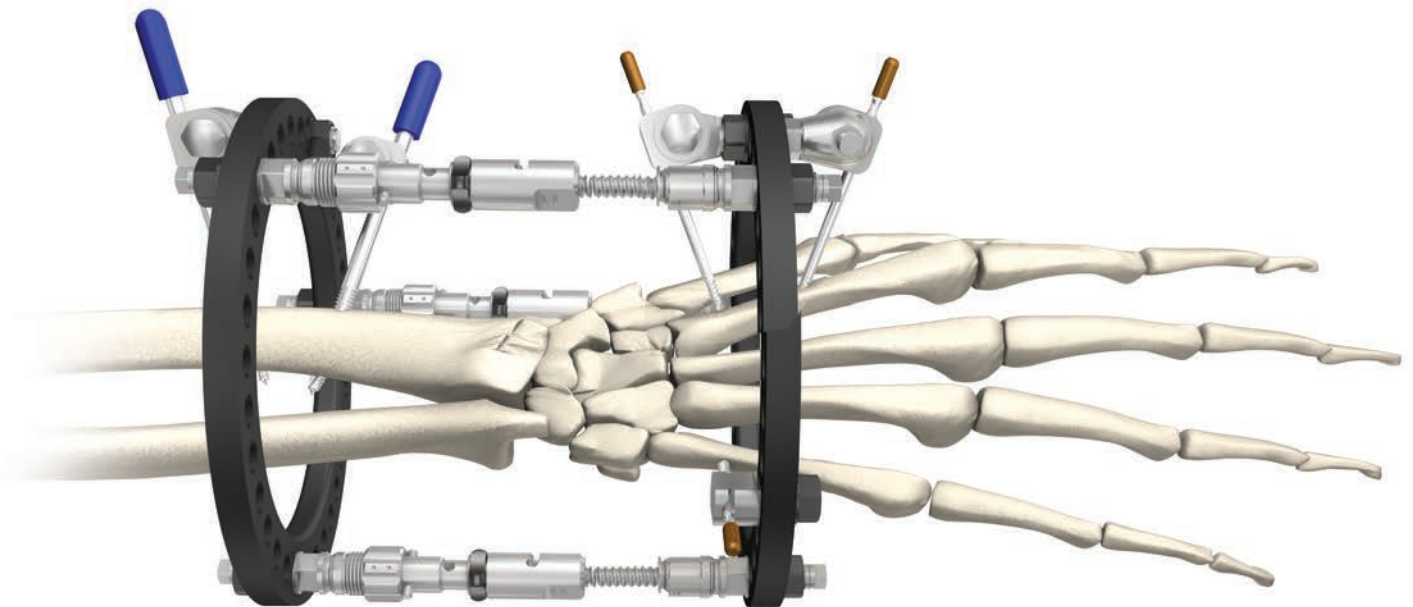

Caution:

Confirm all nuts and connections are tightened upon completion of frame. Confirm all quick release mechanisms and ball joints on struts are in locked position.

Frame examples

Distal radius frame components

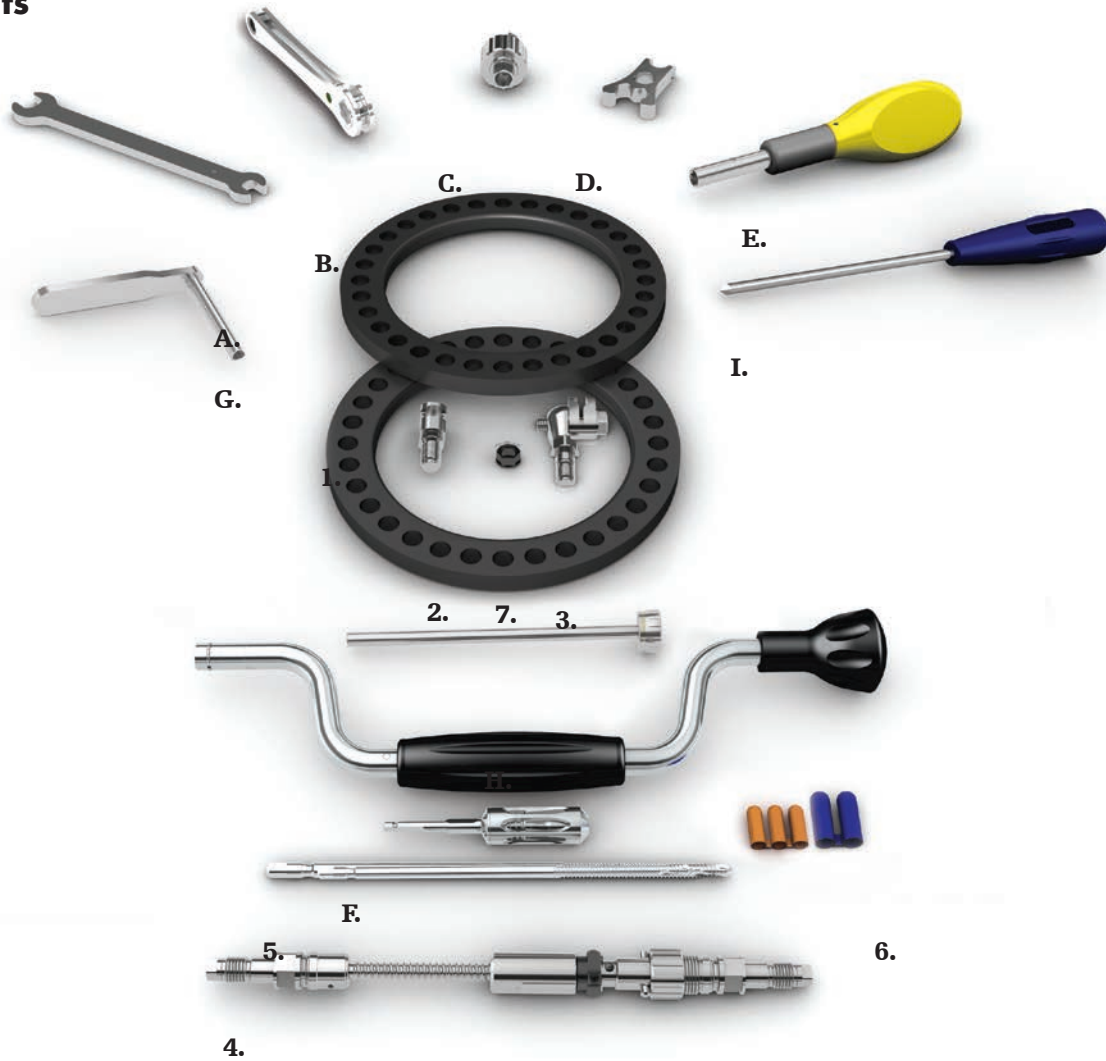

Components used

- | | |
|-----------------------------|---------------------------|
| 1. 2 x Full ring | 5. 5 x Apex pin |
| 2. 1 x Apex pin bolt, short | 6. 5 x End cap |
| 3. 4 x Apex pin adaptor | 7. 11 x M8 connecting nut |
| 4. 3 x Telescopic strut | |

Instruments used

- | | |
|----------------------------------|-----------------------------------|
| A. Spanner wrench 7/10mm | F. Drill brace or universal chuck |
| B. Ratchet wrench | G. Soft tissue sleeve |
| C. Thumbwheel for ratchet wrench | H. Drill sleeve |
| D. Telescopic strut wrench | I. Trocar |
| E. Pin driver | |

Trauma & Extremities

This document is intended solely for the use of healthcare professionals. A surgeon must always rely on his or her own professional clinical judgment when deciding whether to use a particular product when treating a particular patient. Stryker does not dispense medical advice and recommends that surgeons be trained in the use of any particular product before using it in surgery.

The information presented is intended to demonstrate a Stryker product. A surgeon must always refer to the package insert, product label and/or instructions for use, including the instructions for Cleaning and Sterilization (if applicable), before using any Stryker product. Products may not be available in all markets because product availability is subject to the regulatory and/or medical practices in individual markets. Please contact your Stryker representative if you have questions about the availability of Stryker products in your area.

Stryker Corporation or its divisions or other corporate affiliated entities own, use or have applied for the following trademarks or service marks: Apex, Hoffmann, Stryker. All other trademarks are trademarks of their respective owners or holders.

Content ID: H-ST-1_Rev. 3, 12-2016
Copyright © 2016 Stryker



CE 0123

Manufacturer:

Stryker GmbH
Bohnackerweg 1
2545 Selzach
Switzerland

stryker.com