

## Accessories

### User manual

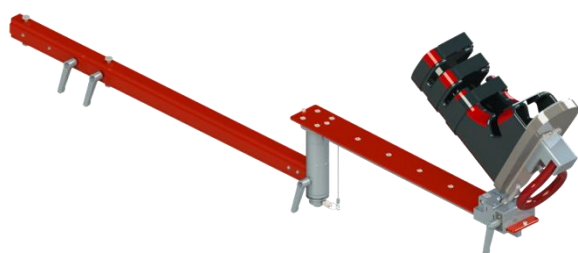

**Opposite Leg Holder / Opposite Leg Holder Denyer**



**Opposite Leg Holder Denyer Plus**

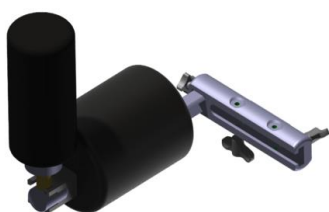

**Perineal Operative Post**

for the product:

**PURIST Leg Positioning System**

**Manufacturer****ADSM**

7b rue Lavoisier  
69680 Chassieu  
France  
Phone: +33 428-710-310  
Fax: +33 428-710-320  
Email: [office@synchronomedical.com](mailto:office@synchronomedical.com)

**Distributor**  
(US and Canada)

Innovative Orthopedic Technologies, LLC  
1115 Hwy 124  
Winnie, TX 77665  
U.S.A.  
Phone: +1 409-658-1017  
Fax: +1 888-521-5676  
Email: [info@iotiot.com](mailto:info@iotiot.com)

**Distributor**  
(outside the US and Canada)

Innovative Orthopedic Technologies IOT AG  
Schochenmühlestrasse 4  
CH-6340 Baar  
Switzerland  
Phone: +41 41-749-4099  
Fax: +41 41-511-2248  
Email: [info@iotiot.com](mailto:info@iotiot.com)

This document may not be circulated, reproduced, used or disclosed to third parties, neither wholly nor in part, without the prior written consent of ADSM.

Non-compliance may result in liability to indemnify.  
Non-contractual pictures.

Please preserve this user manual carefully.

For versions of this manual in other languages, please visit [www.iotiot.com](http://www.iotiot.com).

**Products**

Opposite Leg Holders, Perineal Operative Post

**References**

6813009, 6813040, 6813049, 6813002

**BUDI-DI code**

37010910DT008PURISTC6

**Document number**

SUP\_7.038

**Version**

Rev01

**Release Date**

15/10/2020

**Author**

ADSM



## Table of contents

<b>Table of contents .....</b>	<b>3</b>
<b>1. Notes for users .....</b>	<b>5</b>
1.1. Using this user manual.....	5
1.2. Structure of this user manual.....	5
1.3. User manuals are part of the device .....	6
1.4. Warning and hazard symbols .....	7
1.5. Warning signs and symbols on the product and the packaging .....	8
1.6. Typographical conventions and symbols .....	10
1.7. Figures in this user manual.....	10
<b>2. Information concerning all products .....</b>	<b>11</b>
2.1. Conformity .....	11
2.2. Check upon receipt.....	11
2.3. Product service life .....	11
2.4. Warranty and guarantee .....	12
2.5. Original replacement parts .....	12
2.6. Information on product liability .....	12
<b>3. Opposite leg holder variants .....</b>	<b>13</b>
3.1. Product description for opposite leg holder variants .....	13
3.1.1. Full illustration of opposite leg Holder variants .....	13
3.1.2. Scope of delivery and components .....	14
3.1.3. Device properties .....	16
3.2. General safety information .....	17
3.2.1. Intended use .....	17
3.2.2. Use in contradiction to the intended use.....	18
3.2.3. Hazards when used as intended .....	19
3.2.4. Qualifications of operating, assembly and maintenance personnel .....	22
3.2.5. Material compatibility.....	22
3.3. Assembly of Opposite Leg Holder variants .....	23
3.3.1. General mounting information.....	23
3.3.2. Mounting sequence.....	23
3.3.3. Safety information for mounting.....	24
3.3.4. Preparation.....	28
3.3.4.1. Removing the leg section of the operating table	28
3.3.5. Mounting the extension rail on the accessory rail of the operating table .....	29
3.3.5.1. Extension rail US/EU, Denyer, or Denyer plus	29
3.3.5.2. Extension rail Denyer plus	30
3.3.6. Mounting the extension deck on the extension rail.....	33
3.3.6.1. Extension rail US/EU and extension rail Denyer	33
3.3.7. Mounting the ball-heel slider on the extension deck .....	35
3.3.8. Mounting the ball-heel adapter on the ball-heel slider .....	36
3.3.9. Defining the position of the ball-heel slider on the extension deck .....	37
3.3.10. Mounting the traction boot on the ball-heel adapter .....	39
3.4. Disassembly .....	42
3.4.1. Opposite Leg Holder US/EU and Denyer/Denyer Plus .....	42
3.5. Commissioning.....	42

---

3.6.	Operation .....	43
3.6.1.	Adjusting the extension deck .....	47
3.6.2.	Adjusting the ball-heel adapter .....	47
3.7.	Troubleshooting .....	49
3.8.	Technical data .....	50
3.9.	Components and Accessory Parts .....	51
<b>4.</b>	<b>Perineal Operative Post (POP) .....</b>	<b>52</b>
4.1.	Intended use .....	52
4.2.	Use in contradiction to the intended use .....	52
4.3.	Hazards when used as intended .....	53
4.4.	Scope of delivery .....	55
4.5.	Material compatibility .....	56
4.6.	Load bearing capacity .....	57
4.7.	Preparation .....	59
4.7.1.	Removing the leg section of the operating table .....	60
4.8.	Mounting the perineal operative post .....	61
4.9.	Adjust the Femoral Support .....	63
4.10.	Technical data POP .....	64
4.11.	Wear parts .....	65
<b>5.</b>	<b>Maintenance/service .....</b>	<b>66</b>
5.1.	Important information .....	66
5.2.	Checks by the operating company .....	67
5.3.	Maintenance plan .....	67
5.4.	Maintenance work .....	68
5.4.1.	Cleaning .....	68
5.4.2.	Disinfection .....	68
<b>6.</b>	<b>Transport, storage, and disposal .....</b>	<b>69</b>
6.1.	Transporting while assembled .....	69
6.2.	Decontamination before shipping .....	69
6.3.	Storage .....	69
6.4.	Disposal .....	69
<b>7.</b>	<b>Revision .....</b>	<b>70</b>

## **1. Notes for users**

### **1.1. Using this user manual**

This user manual is intended to ensure safe operation of the products.

- ▶ Use these products only in accordance with the safety instructions and warnings in this user manual.
- ▶ If you have any questions regarding the operation of the products, please contact the distributor.

### **1.2. Structure of this user manual**

This user manual describes the use and assembly of the individual products in the following chapters:

Opposite Leg Holder variants                      Chapt. 3

Perineal Operative Post                              Chapt. 4

Topics concerning all products are discussed in chapters 1, 2, 5 and 6:

Notes for users    Chapt. 1

Information concerning all products              Chapt. 2

Maintenance/service                                  Chapt. 5

Transport, storage, disposal                      Chapt. 6

### **1.3. User manuals are part of the device**

The following documents forms part of the device:

The User Manual of PURIST SUP\_7.036

This User Manual SUP\_7.038

It promotes the intended use of the device and contains important information to install, operate and maintain the device safely and efficiently.

- ▶ Keep this manual complete, legible and accessible to personnel at all times.
- ▶ Read this manual and especially all safety instructions and warnings thoroughly before you put the devices into operation for the first time.
- ▶ This manual contributes to reducing the risk of injury or illness and to prevent the risk of damage, malfunction or inefficient operation of the devices.
- ▶ If transferring the devices to third parties, include these instructions with it.
- ▶ If you lose these instructions, please order a replacement from your distributor.

## 1.4. Warning and hazard symbols



### **DANGER**

**Risk of death or serious injury**

Failure to observe WILL lead to death or serious injury.

---



### **WARNING**

**Risk of death or serious injury**

Failure to observe CAN lead to death or serious injury.

---



### **CAUTION**

**Risk of slight injury**

A hazard which CAN lead to slight injury.

---



### **ATTENTION**







**Warning – property damage**

A hazard that CAN cause damage to or malfunctions of the product, equipment, other devices, etc.





---



### 1.5. Warning signs and symbols on the product and the packaging

Symbol	Meaning
 <b>Read the user manual!</b>	<ul style="list-style-type: none"> <li>▶ Read the user manual.</li> <li>▶ Observe important notice in the user manual.</li> <li>▶ Read the user manual before installing and using the device.</li> </ul>
 <b>WARNING!</b>	<p><b>WARNING</b></p> <p>Hazard symbols indicating possible injuries at the location of the symbol.</p>
 <b>Caution: Keep hands clear</b>	<p><b>Crushing hazard for hands</b></p> <p>Warning sign indicating a crushing hazard for hands at the location of the symbol.</p>
<p><b>Boot</b></p>	<p><b>Note</b></p> <p>Clamping lever for releasing/tightening the ball-heel adapter</p>
<p><b>Slide</b></p>	<p><b>Note</b></p> <p>Clamping lever for releasing/tightening the ball-heel slider</p>





Symbol	Meaning
	<p><b>CAUTION: SEE INSTRUCTION MANUAL</b></p>
	<p>CE-mark</p>
	<p>Batch number</p>
	<p>Reference number</p>
	<p>Manufacturer</p>
	<p>Non Sterile Device</p>



	<p>Body weight</p>
	<p>Unique Device Identifier</p>
<p>Rx only</p>	<p>Prescription-only</p>
	<p>READ THE INSTRUCTIONS</p>
	<p>Medical Device</p>

<p><b>Symbols on the packaging</b></p>	
	<p>This side up</p>
	<p>Fragile; treat with the required care</p>
	<p>Keep dry</p>

### 1.6. Typographical conventions and symbols

Symbol	Meaning
	Notice with especially useful information and tips
	Request for action
	Result of a request for action
	List point 1
	List point 2

### 1.7. Figures in this user manual

Some of the figures in this user manual are schematics where the colors do not necessarily correspond to the final product.

## 2. Information concerning all products

### 2.1. Conformity



These medical products comply with the provision of Medical Device REGULATION (EU) 2017/745 OF THE EUROPEAN PARLIAMENT AND OF THE COUNCIL of 5 April 2017 on medical devices, amending Directive 2001/83/EC, Regulation (EC) No 178/2002 and Regulation (EC) No 1223/2009 and repealing Council Directives 90/385/EEC and 93/42/EEC

#### Medical Device Class

All accessories are classified according to annex VIII, chapter III, rule 1 of the MDR:

**Class I** general, non-sterile, no measuring function.

### 2.2. Check upon receipt

Immediately on receipt, check that the components are complete and undamaged. Report any transport damage to the distributor immediately.



#### **WARNING**

##### **Risk of contamination**

These devices are not shipped in sterile condition.

- ▶ Please clean and disinfect the devices according to the procedures approved by your organization.

### 2.3. Product service life

The devices were developed for an expected service life of 10 years.

This does not apply to wear parts such as pads on the POP and femoral support.

## **2.4. Warranty and guarantee**

The warranty provisions form part of the distributor's General Terms and Conditions.

Using unauthorized replacement parts voids the warranty.

## **2.5. Original replacement parts**

The manufacturer shall only be liable for the safety of the products if the products are maintained by authorized maintenance personnel and if original replacement parts are used. This applies to maintenance, repairs and modifications.

## **2.6. Information on product liability**

### **Manufacturer's liability**

ADSM shall only be liable for safe operation, reliability and performance of the products if:

- Assembly and maintenance are carried out solely by persons authorized to do this by ADSM.
- the device is operated according to this user manual.
- the product is used within the scope of application described here.
- no unauthorized modifications are made to the product.

### 3. Opposite leg holder variants

#### 3.1. Product description for opposite leg holder variants

##### 3.1.1. Full illustration of opposite leg Holder variants

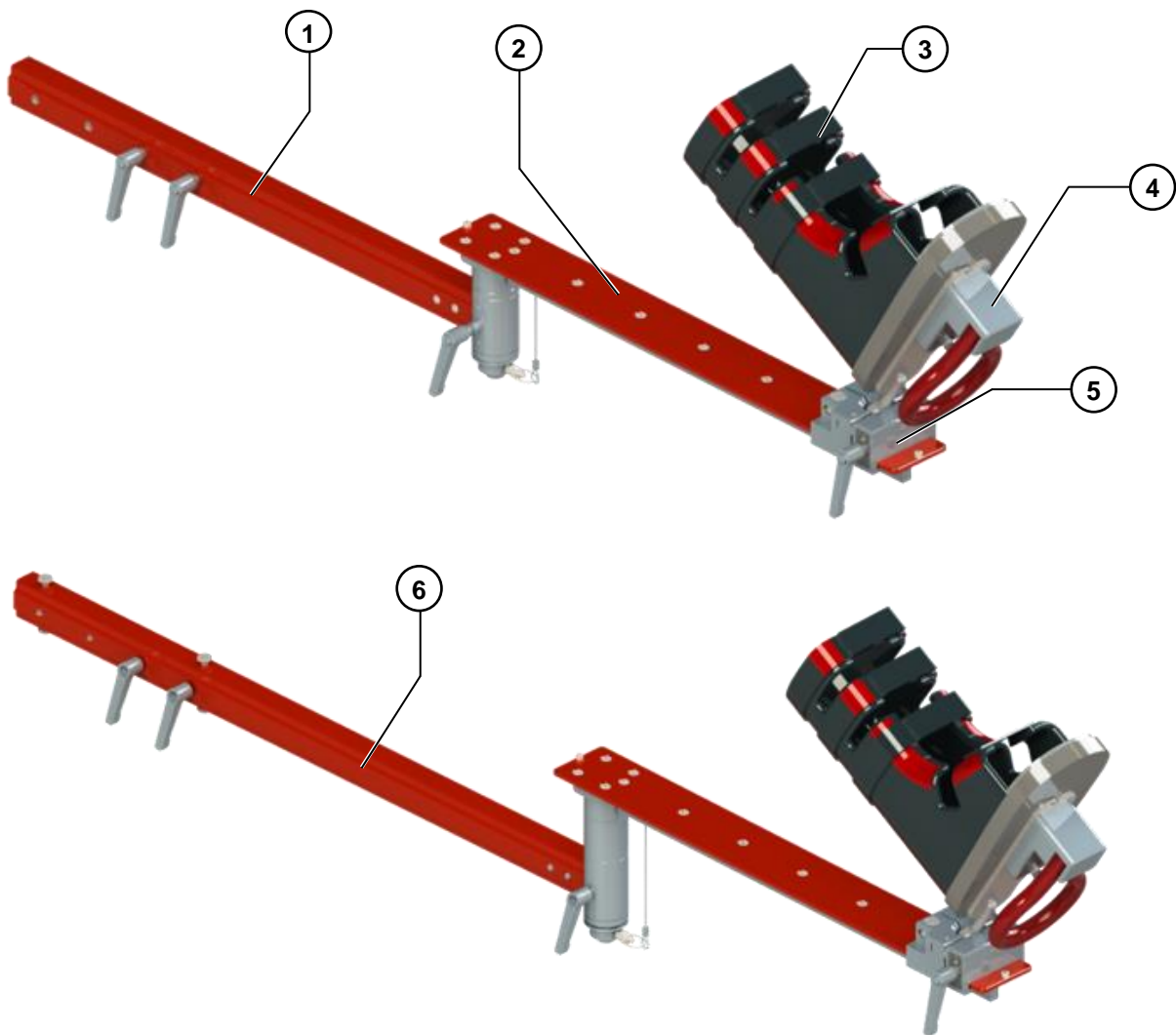

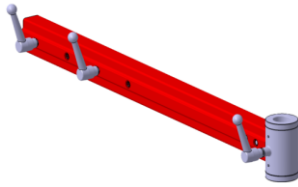
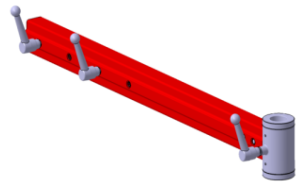

Fig. 3-1: Overview of opposite leg holder variants





- |   |   |   |                            |
|---|---|---|----------------------------|
| 1 | Extension rail US/EU or extension rail Denyer | 4 | Ball-heel adapter          |
| 2 | Extension deck                                | 5 | Ball-heel slider           |
| 3 | Boot size M                                   | 6 | Extension rail Denyer plus |

### 3.1.2. Scope of delivery and components

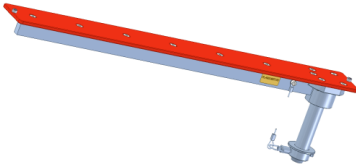
The scope of delivery for the opposite leg holder system consists of the following components:

- The common names will be used throughout this manual.

Image	Quantity	Designation	Description (Common Name)	Reference	OLH - US/EU 681 3009	OLH - DENYER 681 3040	OLH - DENYER PLUS 681 3049
	1	<b>OLH #ER</b>	Extension Rail US/EU	<b>681 3035</b>	<b>X</b>		
	1	<b>OLH #ERD</b>	Extension Rail Denyer	<b>681 3041</b>		<b>X</b>	
	1	<b>OLH #ERDP</b>	Extension Rail Denyer Plus	<b>681 3048</b>			<b>X</b>
	1	<b>OLH #ED</b>	Extension Deck	<b>681 3037</b>	<b>X</b>	<b>X</b>	<b>X</b>

	1	<b>OLH #BHS</b>	Ball-Heel Slider	<b>681 3122</b>	<b>X</b>	<b>X</b>	<b>X</b>
	1	<b>OLH #BHA</b>	Ball-Heel Adapter	<b>681 3123</b>	<b>X</b>	<b>X</b>	<b>X</b>
	1	<b>PURIST / OLH - Boot M</b>	Boot size M	<b>688 3314</b>	<b>X</b>	<b>X</b>	<b>X</b>
	*	<b>PURIST / OLH - Boot S</b>	Boot size S	<b>688 3360</b>	<b>*</b>	<b>*</b>	<b>*</b>

\*Optional part

The leg holder deck system\*\* includes the following:

- Extension deck
- Ball-heel slider
- Ball-heel adapter
- Boot size M

\*\* This reference is only a reference group and not a product reference.

### 3.1.3. Device properties

The Opposite Leg Holder (OLH) is an extension of the operating table which is mounted on the accessory rails on the left or right of the operating table for surgeries on the hip, pelvis or lower extremities.

The device allows safe and reproducible positioning of the non-operative leg while the patient is in a supine position. Fixing the foot in the Traction Boot provides support for the entire leg. The Traction Boot can be moved on a slide rail using a slide. This makes the product suitable for different leg lengths up to 1100 mm inner leg length. Leg abduction can be achieved with a pivot bearing.

The Opposite Leg Holder is supplied in three variants:

- The OLH Leg Holder Deck System is mounted directly on either:
  - the Extension Rail US/EU (3/8"x 1 1/8" or 10 x 25 mm) or
  - the Extension Rail Denyer (6.35 x 38.1 mm) or
  - the Extension Rail Denyer Plus (6.35 x 38.1 mm)



## **3.2. General safety information**

### **3.2.1. Intended use**

The device is designed exclusively for the described intended use.

The device Opposite Leg Holder, Opposite Leg Holder Denyer, and Opposite Leg Holder Denyer Plus are accessories for operating tables that are mounted on the accessory rails on the left or right of the operating table for surgeries on the hip, pelvis or lower extremities. The dimensions and load data for the accessory rails have to be compatible with the Opposite Leg Holder.

The accessories listed are intended exclusively for use in combination with the medical device:

- PURIST Leg Positioning System

The device allows safe and reproducible positioning of non-operative leg during the surgery while the patient is in a supine position. Fixing the foot in the Traction Boot provides support for the entire leg. The Traction Boot can be moved on a slide rail using a slide. This makes the product suitable for different leg lengths up to 1100 mm inner leg length. Leg abduction can be achieved with a pivot bearing.

The product may only be used as an accessory for operating tables where the lateral accessory rails are compatible with the product with regard to geometry and load capacity.

Installation and operation are carried out by specialized surgical staff who are familiar with patient positioning.

The period of use of the product is about 1 to 4 hours per procedure/surgery.

### 3.2.2. Use in contradiction to the intended use

The device must not be used for any other purpose than that indicated in chapter Intended use.



#### **CAUTION**

##### **Hazard from use in contradiction to the intended use**

Use of the device in contradiction to the intended use can lead to dangerous situations. The following are particularly regarded as contradictions to intended use:

- ▶ Use of the device in environments not set up according to the relevant provisions and guidelines for the erection of medical rooms.
  - ▶ Use of a damaged device.
  - ▶ Use of an incorrectly assembled device.
  - ▶ Allowing unqualified personnel to use the device.
  - ▶ Use of the product to exert traction on the leg.
  - ▶ Operating the clamping lever with a hammer. Only operate the clamping lever by hand.
-

### 3.2.3. Hazards when used as intended



#### **WARNING**

##### **Risk of injury from thrombosis**

Holding the leg in the same position for a long period of time during a surgery can give rise to blood clots in the veins (thrombosis).

- ▶ The attending physician has to take counter measures during longer surgeries.
- 



#### **WARNING**

##### **Risk of contamination from the product**

This device is not shipped in sterile condition. There is a risk of infection.

- ▶ Please clean and disinfect the product according to the procedures approved by your organization.
  - ▶ The product has to be covered during the surgery.
  - ▶ The operator has to remain in the non-sterile area behind the product during the surgery.
- 



#### **WARNING**

##### **Risk of injury from tilting of the operating table**

If the product is not mounted on the middle section of the operating table, the operating table may tilt and cause injuries.

- ▶ Only mount the product on the middle section of an operating table.
  - ▶ Ensure to follow user instructions of the OR table used. Sometimes flipping the OR table 180 degrees may influence the stability of the OR table.
- 



#### **CAUTION**

##### **Risk of injury from defective components**

Defective components pose a risk of injury.

- ▶ Stop using the device.
  - ▶ Replace defective components only with original spare parts.
  - ▶ Observe the liability information concerning the use of non-original spare parts.
-

**CAUTION****Danger from injuries caused by the traction boot (bruises, crushing)**

Frequent use and cleaning can have a negative effect on the boot material. In operations which last several hours, pressure sores can occur – especially with patients who are slimly built or have sensitive skin.

- ▶ Replace the boot when necessary.
  - ▶ Make sure of sufficient cushioning and correct fixture of the foot in the boot.
  - ▶ Select optimal boot size.
-



**CAUTION**

**Danger from injuries due to loose clamping levers**

If the clamping levers are loose, there is a risk that the stored patient leg can slip during the operation.

- ▶ Tighten all clamping levers on the OLH.
- ▶ Check the clamping lever regularly for tightness.
- ▶ Replace defective components with original spare parts.



**CAUTION**

**Risk of injury from OLH breaking**

The OLH may break in case of heavy patients over 227 kg (500lb.)

- ▶ Use product only for patients of max. 227kg (500 lb.)



**ATTENTION**

**Exceeding the maximum permitted load may cause the accessory rails of the operating table to break**

The product or the accessory rails of the operating table may break when used with heavy persons over 227 kg (500 lb.) bodyweight.

- ▶ The operating company has to ensure that each accessory rail for the operating table has a maximum load capacity of 1800 N and a maximum torque of 550 Nm.



**CAUTION**

**Risk of injury from incorrect assembly**

If the product is not mounted on the middle section of the operating table, the operating table may tilt and cause injuries.

- ▶ Only mount the product on the middle section of an operating table.

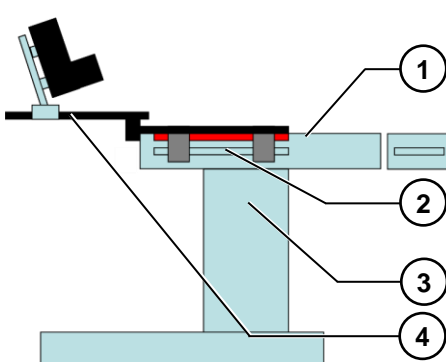

- 1 Middle section of operating table
- 2 Accessory rail of operating table
- 3 Base of operating table
- 4 Opposite Leg Holder

Fig. 3-2: Correct position on the operating table

### 3.2.4. Qualifications of operating, assembly and maintenance personnel

This device may only be assembled, operated and maintained by properly trained technical personnel.

- ▶ Before assembly, use and maintenance, carefully read the operating instruction and familiarize yourself with the device.

### 3.2.5. Material compatibility

---

#### **ATTENTION**

##### **Corrosive substances can damage the product**

Use of corrosive substances for cleaning can damage the product.

- ▶ Only use substances for cleaning which do not corrode the following materials.
  - ▶ Observe the cleaning instructions.
-

### **3.3. Assembly of Opposite Leg Holder variants**

#### **3.3.1. General mounting information**

The Opposite Leg Holder is an extension of the operating table. It is mounted on the operating table to position the non-operative leg during hip joint surgeries. After the surgery, the product is removed, cleaned, disinfected and stored.

#### **3.3.2. Mounting sequence**

- ▶ Mount the Opposite Leg Holder in the following sequence:
  - Extension Rail US/EU, Extension Rail Denyer, or Extension Rail Denyer Plus
  - Extension deck
  - Ball-heel slider
  - Ball-heel adapter
  - Traction boot

**3.3.3. Safety information for mounting****CAUTION****Risk of injury from mounting on incompatible operating table accessory rails**

If the Opposite Leg Holder is mounted on incompatible operating table accessory rails, this can lead to falling and consequently to injuries.

Each operating table accessory rail has to have a maximum load capacity of 1800 N and a maximum torque of 550 Nm. The operating company is responsible for checking the compatibility.

- ▶ Ensure that the Opposite Leg Holder and the operating table accessory rails are compatible.
- 

**CAUTION****Risk of injury from mounting on defective operating table accessory rails**

If the Opposite Leg Holder is mounted on defective operating table accessory rails, this can lead to falling and consequently to injuries.

- ▶ Before mounting, always ensure that there is no damage on the accessory rails of the operating table.
- 

**CAUTION****Risk of injury from loose screws**

If the screws on the Opposite Leg Holder are not tightened properly, injuries may occur during surgery.

- ▶ Before mounting the Opposite Leg Holder, always ensure tight seating of all screws and have the screws tightened by qualified personnel if required.
- 

**WARNING****Risk of contamination**

The product may contain bacteria and germs from previous surgeries which pose a risk to patients and operating personnel.

- ▶ Clean and disinfect the product after each surgery according to regulations.
  - ▶ Disinfect the product before each surgery according to regulations.
-



**WARNING****Risk of injury from incorrect position on the operating table**

If the product is not mounted on the middle section of the operating table, the operating table may tilt and cause injuries.

- ▶ Only mount the product on the middle section of an operating table.

**CAUTION****Risk of injury from incorrect actuation of the clamping levers**

Actuation of the clamping levers creates a risk of injury in the form of grazed fingers.

- ▶ Actuate the clamping lever carefully.
- ▶ Maintain a space between knuckles and edge.



Fig. 3-3: *Incorrect grip of the clamping lever*



Fig. 3-4: *Correct grip of the clamping lever*

- ▶ Maintain a space between knuckles and edge.



Fig. 3-5: *Incorrect grip of the clamping lever*



Fig. 3-6: *Correct grip of the clamping lever*

► Maintain a space between knuckles and edge.



### CAUTION

#### Risk of injury from clamping lever

After tightening, the clamping lever may be in a position which can pose a risk of injury for patient and personnel.

► After tightening, turn the clamping lever to a position which poses no risk of injury.



The position of the clamping levers can be changed without releasing the clamping bolt.

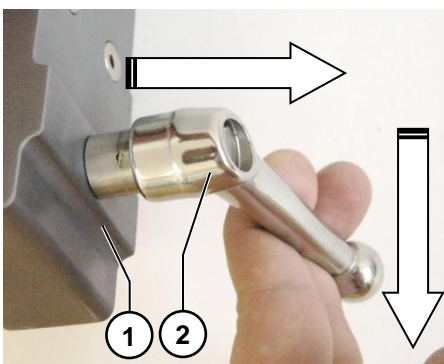

Fig. 3-7: *Positioning the clamping lever*

- 1 Fixing profile
- 2 Clamping lever with clamping bolt

► First pull the clamping lever away from the fixing profile and then turn into the desired position without turning the clamping bolt.



*Fig. 3-8: Clamping lever turned downwards*

### 3.3.4. Preparation

- ▶ Ensure that all accessory parts required for mounting the product are available.
- ▶ Ensure that all accessory parts are in full working order.
- ▶ Ensure that all screws are tightened.



### WARNING

#### Risk of injury from tilting of the operating table

If the product is not mounted on the middle section of the operating table, the operating table may tilt and cause injuries.

- ▶ Only mount the product on the middle section of an operating table.
- ▶ Ensure to follow user instructions of the OR table used. Sometimes flipping the OR table 180 degrees may influence the stability of the OR table. If the table is flipped 180 degrees, the head section and leg sections shown in the figures below are interchangeable.

#### 3.3.4.1. Removing the leg section of the operating table

- ▶ Remove the leg section (1) of the operating table.

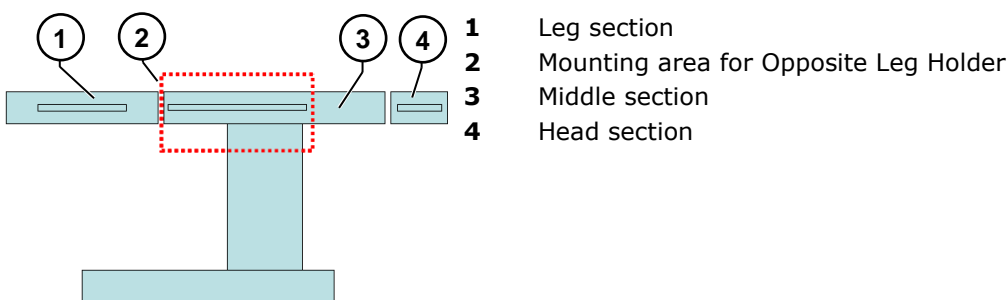

Fig. 3-9: Operating table with leg section

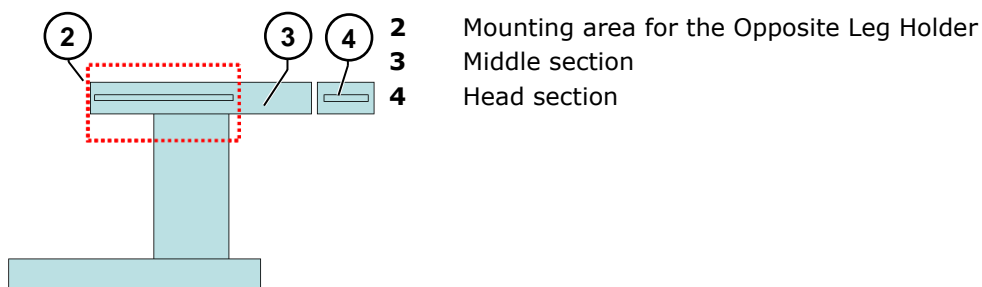

Fig. 3-10: Operating table without leg section

### 3.3.5. Mounting the extension rail on the accessory rail of the operating table

#### 3.3.5.1. Extension rail US/EU, Denyer, or Denyer plus



The extension rail variants can be mounted on the left or on the right accessory rail of the operating table by turning it over.

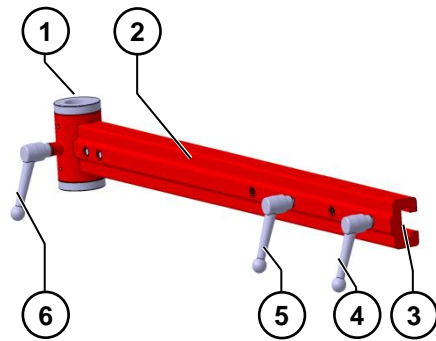

Fig. 3-11: Extension rail US/EU or extension rail Denyer

- 1 Pivot bearing bushing
- 2 Extension rail
- 3 T-slot profile
- 4 Clamping lever small
- 5 Clamping lever small
- 6 Clamping lever small

- ▶ Release the clamping levers (4, 5), but do not turn out fully.
- ▶ Slide the extension rail (2) with the T-slot profile (3) onto the accessory rail of the operating table so that the clamping levers (4, 5) point outwards, away from the table.
- ▶ Tighten the clamping levers (4, 5) manually.



### CAUTION

#### Risk of injury from breaking extension rail

The extension rail (2) can break if it is not clamped to the accessory rail with the two clamping levers (4, 5).

- ▶ Slide the extension rail (2) onto the accessory rail far enough so the two clamping levers (4, 5) can be used to clamp the extension rail to the accessory rail.
- ▶ Do not use the extension rail if only one clamping lever is tightened.



### CAUTION

#### Danger from injuries due to loose clamping levers

If the clamping levers are loose, there is a risk that the stored patient leg may slip during the operation.

- ▶ Tighten all clamping levers on the OLH.
- ▶ Check the clamping lever regularly for tightness.
- ▶ Replace defective components with original spare parts.

Opposite leg holder variants

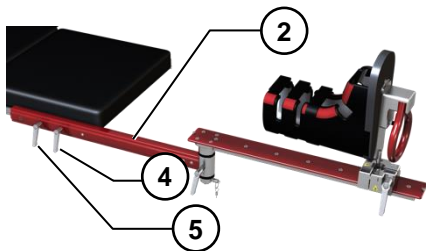

Fig. 3-12: Extension rail on OR table

The T-slot profile of the extension rail fits the left as well as the right accessory rail on the operating table.

- ▶ Slide the extension rail (2) onto the accessory rail so that the clamping levers (4, 5) point outwards, away from the table.
- ▶ Ensure that both clamping levers (4, 5) clamp the extension rail to the accessory rail.

3.3.5.2. Extension rail Denyer plus

When using a tabletop (MP XRAYCER, DAA Top 360), the lying surface of the operating table is extended by approx. 20 cm. A conventional Opposite Leg Holder or Opposite Leg Holder Denyer is therefore too short for the support of the non-operative legs.

The OLH Denyer Plus has an extension rail designed 20 cm longer to compensate for this difference.

When using an Opposite Leg Holders Denyer Plus, the conventional Leg Holder Deck System can continue to be used with the new Extension Rail Denyer Plus. However, the rotation axis on the extension deck must be replaced.

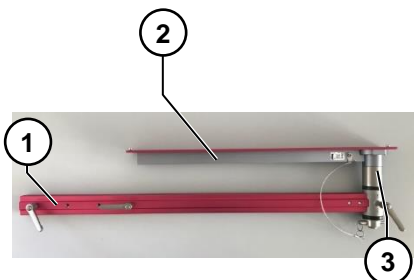

Fig. 3-13: OLH Denyer plus

- 1** Extension rail Denyer plus
- 2** Extension Deck
- 3** Rotation axis Denyer plus

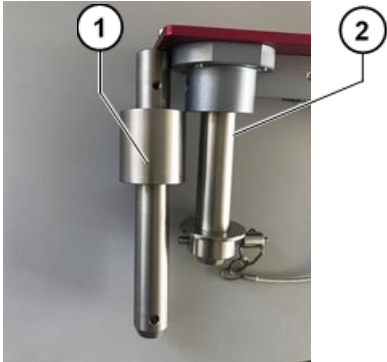

Fig. 3-14: *Rotation axis configurations*

- 1** Rotation axis Denyer plus
- 2** Rotation axis

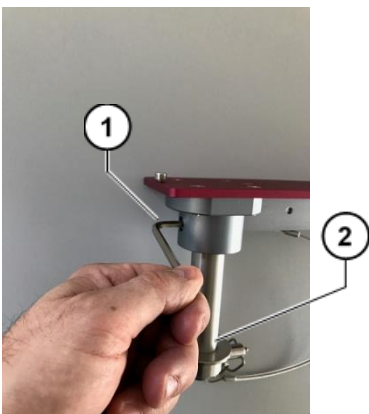

Fig. 3-15: *Rotation axis*

- 1** Allen key
- 2** Rotation axis

- ▶ Loosen Allen screw with an Allen key and remove completely.
- ▶ Pull the rotation axis (2) downwards out of the bearing.

Opposite leg holder variants

- 1 Allen screw
- 2 Rotation axis Denyer plus

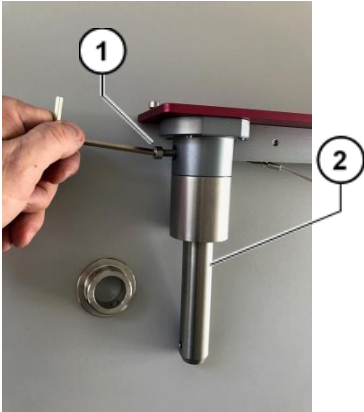

- ▶ Move the longer rotation axis Denyer plus (2) into the bearing.
- ▶ Screw in the Allen screw (1) and tighten.

Fig. 3-16: *Rotation axis Denyer plus*

- 1 Extension rail Denyer plus
- 2 Knurled screws
- 3 Rails

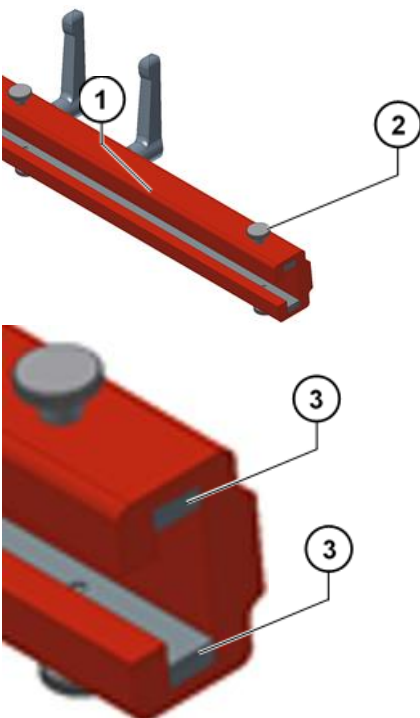

- ▶ For use with EU / US operating table accessory rails, secure the two rails (3) with the four knurled screws (2) in the extension rail Denyer plus.

Fig. 3-17: *Mounting extension rail Denyer plus on EU/US OP-Table accessory rails*



### 3.3.6. Mounting the extension deck on the extension rail

#### 3.3.6.1. Extension rail US/EU and extension rail Denyer

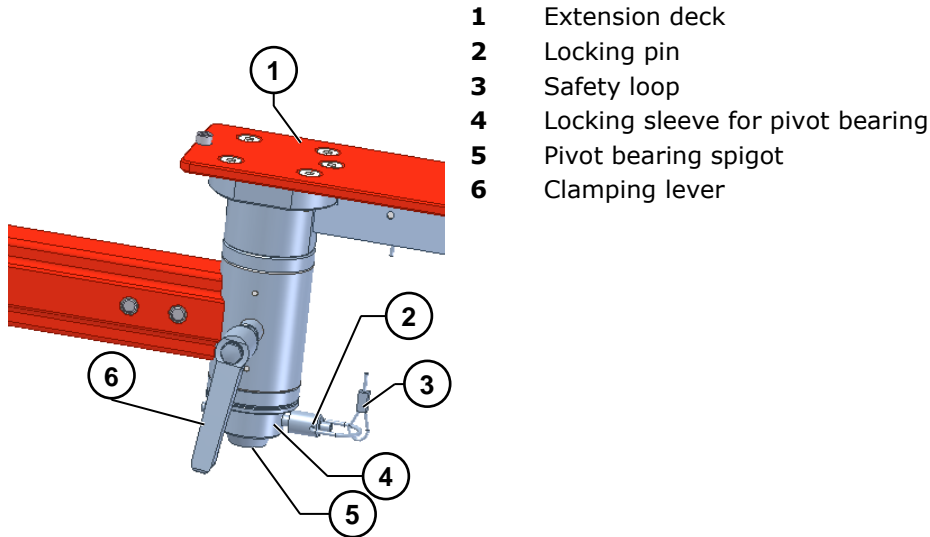

Fig. 3-18: Extension deck / extension rail interface

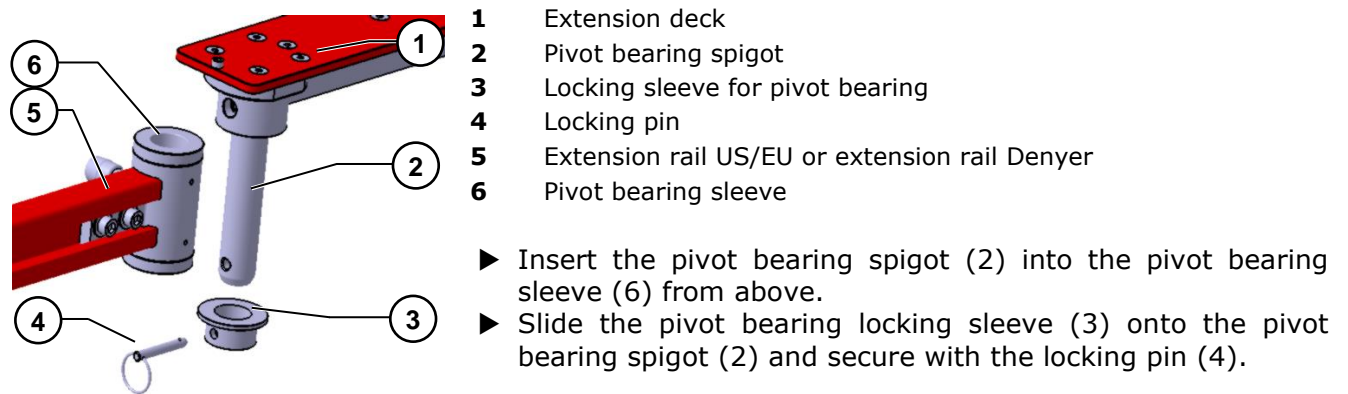

Fig. 3-19: Extension deck with extension rail

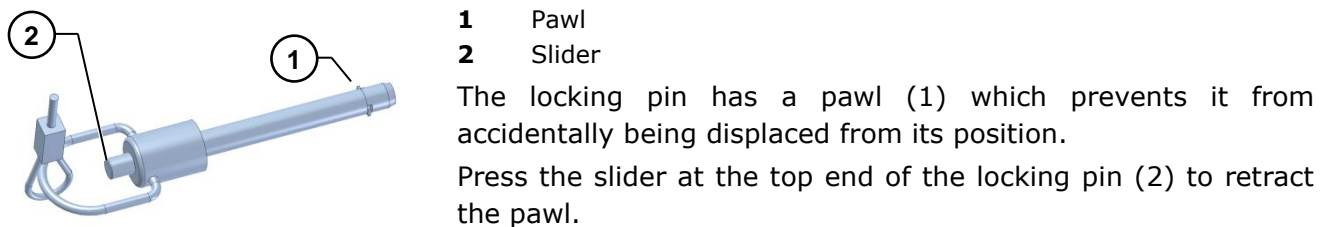
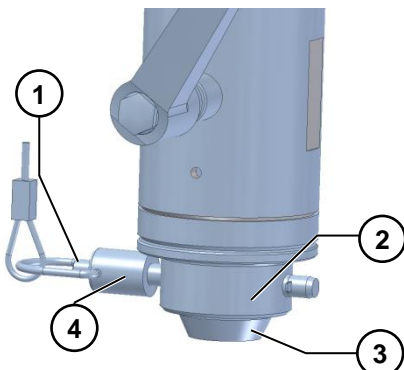

Fig. 3-20: Locking pin

Opposite leg holder variants



- 1** Slider at the top end of the locking pin
- 2** Locking sleeve for pivot bearing
- 3** Pivot bearing spigot
- 4** Locking pin

► Press on the slider at the top end of the locking pin (1) with your thumb and slide the locking pin (4) through sleeve (2) and spigot (3) to the stop.

Fig. 3-21: Securing the pivot bearing

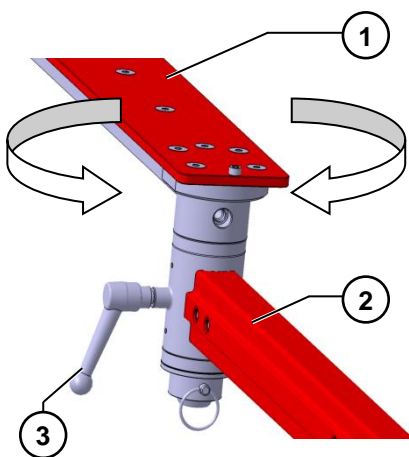

- 1** Extension deck
- 2** Extension rail
- 3** Clamping lever small for pivot bearing

The extension deck (1) can be rotated in the pivot bearing to allow different degrees of adduction for the leg. The extension deck (1) is fixed in the desired position by the clamping lever (3).

The surgeon has to decide how much adduction the leg positioned on the extension deck should have.

Fig. 3-22: Pivot bearing

### 3.3.7. Mounting the ball-heel slider on the extension deck

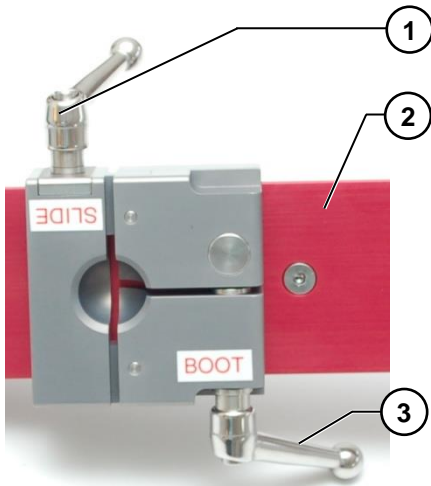

- 1 Clamping lever small "SLIDE"
- 2 Extension deck
- 3 Clamping lever large "BOOT"

The ball-heel slider is equipped with two clamping levers:

- Clamping lever small "SLIDE" for fixing the slider on the extension deck
- Clamping lever large "BOOT" for fixing the ball-heel adapter in the slider

Fig. 3-23: Ball-heel slider

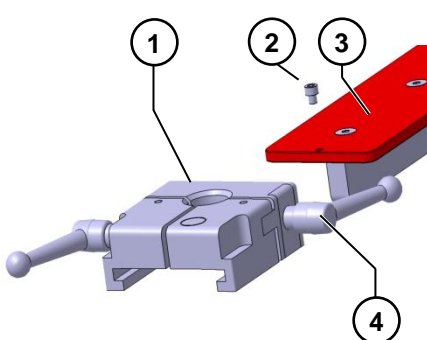

- 1 ball-heel slider
- 2 Stop screw
- 3 Extension deck
- 4 Clamping lever small "Slide"

- ▶ Remove the stop screw (2) from the deck (3).
- ▶ Release the clamping lever small "SLIDE" (4).

Fig. 3-24: Mounting the ball-heel slider

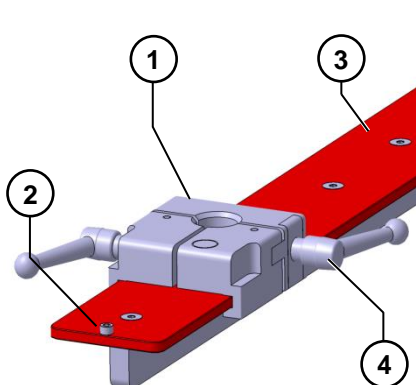

- 1 Ball-heel slider
- 2 Stop screw
- 3 Extension deck
- 4 Clamping lever small "Slide"

- ▶ Slide the ball-heel slider (1) onto the deck (3).
- ▶ Tighten the clamping lever small "SLIDE" (4).
- ▶ Screw in the stop screw (2) and tighten.

Fig. 3-25: Ball-heel slider on the extension deck

### 3.3.8. Mounting the ball-heel adapter on the ball-heel slider

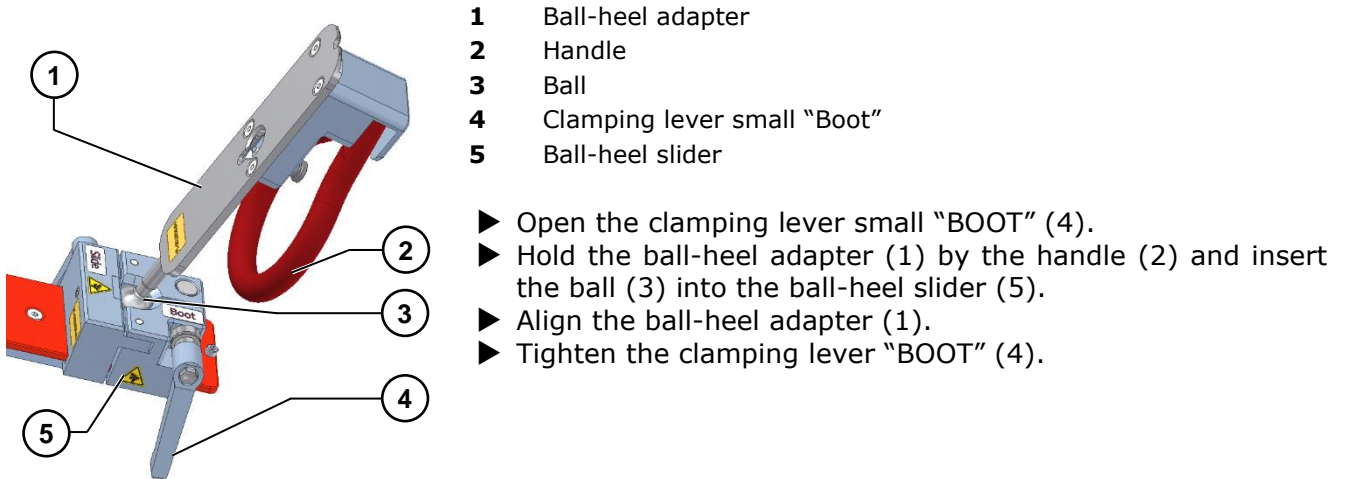

Fig. 3-26: Ball-heel adapter in the ball-heel slider



#### CAUTION

**Risk of injury from incorrect actuation of the clamping levers**

Actuation of the clamping levers creates a risk of injury in the form of grazed fingers.

- ▶ Actuate the clamping lever carefully.
- ▶ Maintain a space between knuckles and edge.



Fig. 3-27: Incorrect grip of the clamping lever



Fig. 3-28: Correct grip of the clamping lever

- ▶ Maintain a distance between knuckles and edge of the ball-heel slider.

### 3.3.9. Defining the position of the ball-heel slider on the extension deck

The ball-heel slider can be moved on the extension deck to adapt it to different leg lengths of the patients.

Legs with a maximum inner leg length of 1100 mm can be fixed in an extended position on the Opposite Leg Holder.

The surgeon has to decide in which position the ball-heel slider should be.

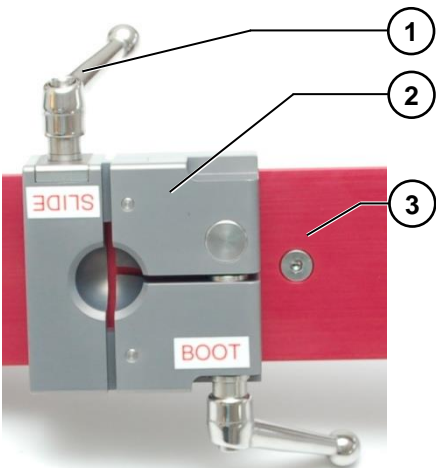

Fig. 3-29: Clamping lever on the ball-heel slider

- 1** Clamping lever for ball-heel slider position (SLIDE)
- 2** Ball-heel slider
- 3** Extension deck

- ▶ Release the clamping lever "SLIDE" (1) for the ball-heel slider (2) and move the ball-heel slider on the extension deck (3).
- ▶ Tighten clamping lever (1).

Opposite leg holder variants

---



*Fig. 3-30: Ball-heel slider in position for long leg length*



*Fig. 3-31: Ball-heel slider in position for medium leg length*

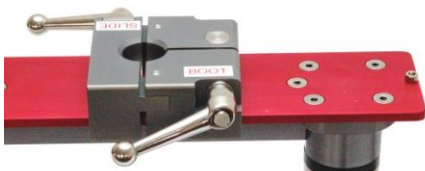

*Fig. 3-32: Ball-heel slider in position for short leg length*

The surgeon has to decide in which position the ball-heel slider should be.

### 3.3.10. Mounting the traction boot on the ball-heel adapter

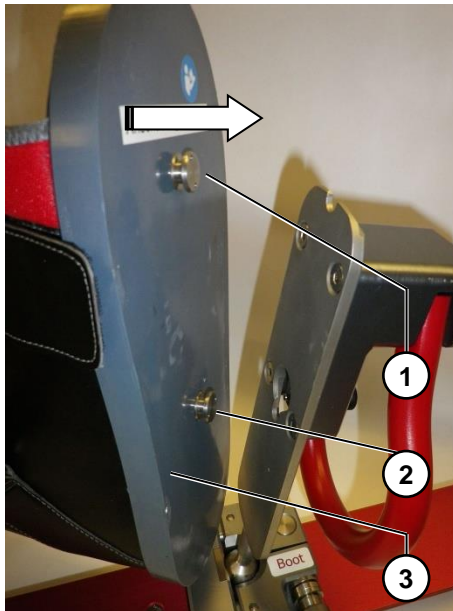

- 1 Upper fixing knob
- 2 Lower fixing knob
- 3 Traction boot

There are two fixing knobs (1, 2) on the sole of the traction boot. The traction boot (3) is mounted on the ball-heel adapter with the two fixing knobs.

- ▶ Hold the ball-heel adapter with one hand.
- ▶ Use the other hand to move the traction boot towards the ball-heel adapter.

Fig. 3-33: Mounting the traction boot 1

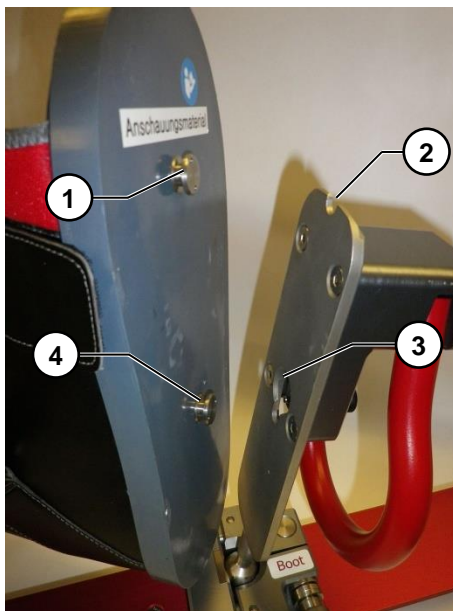

- 1 Upper fixing knob
- 2 Upper notch in the ball-heel adapter
- 3 Lower notch in the ball-heel adapter
- 4 Lower fixing knob

- ▶ First guide the lower fixing knob (4) into the lower notch (3) in the ball-heel adapter until it engages.

Fig. 3-34: Mounting the traction boot 2

## Opposite leg holder variants

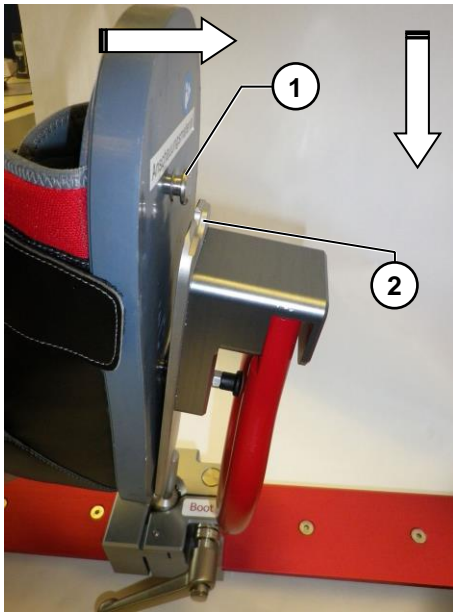

- 1** Upper fixing knob
- 2** Upper notch

- ▶ Once the lower fixing knob has engaged, guide the upper fixing screw over the ball-heel adapter.
- ▶ Slide the traction boot downwards so that the upper fixing knob (1) engages in the notch (2).

Fig. 3-35: *Mounting the traction boot 3*



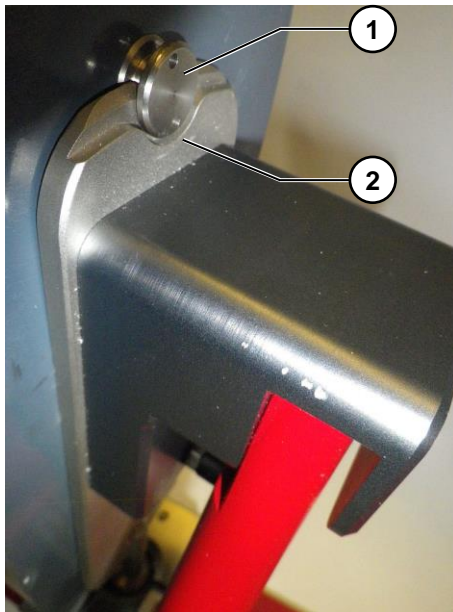

- 1 Upper fixing knob
- 2 Upper notch

The traction boot is correctly fitted when the upper fixing knob (1) has engaged in the notch (2).

Fig. 3-36: Mounting the traction boot 4

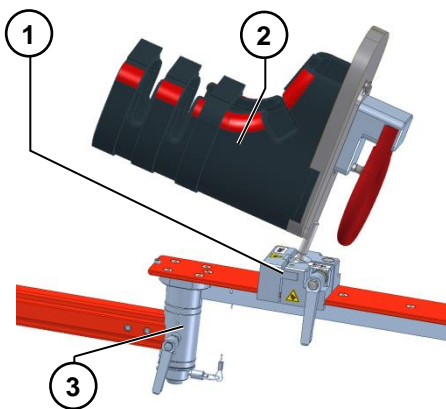

- 1 Ball-heel slider
- 2 Traction boot
- 3 Pivot bearing

► Position the traction boot (2) in the ball-heel slider (1) with the leg opening towards the pivot bearing (3).

Fig. 3-37: Traction boot mounted



## CAUTION

### Risk of injury from OLH breaking

The OLH may break in case of heavy patients over 227 kg (500lb.)

- Use product only for patients of max. 227kg (500 lb.)

### **3.4. Disassembly**

#### **3.4.1. Opposite Leg Holder US/EU and Denyer/Denyer Plus**

After using the product for a hip joint surgery, the product has to be removed from the operating table again.

Disassembly is carried out in the following steps:

- ▶ Remove the traction boot from the ball-heel adapter.
- ▶ Release the clamping lever on the ball-heel slider (Boot) and remove the ball-heel adapter from the ball-heel slider.
- ▶ Pull the locking pin from the pivot bearing and remove the locking sleeve from the pivot spigot.
- ▶ Release the clamping lever on the pivot bearing and remove the extension deck from the pivot bearing.
- ▶ Release the clamping levers from the extension rail.
- ▶ Remove the extension rail from the accessory rail.
- ▶ Tighten the clamping levers so they cannot be lost.
- ▶ Clean and disinfect all parts and package for storage.

### **3.5. Commissioning**

After handover of the product, commissioning is carried out by the operating company.

### 3.6. Operation

This device may only be assembled, operated and maintained by properly trained technical personnel.

- ▶ Before assembly, use, and maintenance of the product, carefully read the manual and become familiar with the device.

After correct mounting of the Opposite Leg Holder on the operating table, the patient's leg which is not operated on can be fixed on an extension deck in a traction boot using the ball-heel adapter.



Usually the leg to be operated on is fixed in a PURIST Leg Positioning System. The second leg is fixed on an extension deck in a traction boot using an adapter.

The surgeon has to decide how the individual components of the Opposite Leg Holder are adjusted.



#### CAUTION

##### Risk of injury from incorrect actuation of the clamping levers

Actuation of the clamping levers creates a risk of injury in the form of grazed fingers.

- ▶ Actuate the clamping lever carefully.
- ▶ Maintain a space between knuckles and edge.



Fig. 3-38: Incorrect grip of the clamping lever

Opposite leg holder variants

---



Fig. 3-39: Correct grip of the clamping lever

► Maintain a space between knuckles and edge.



Fig. 3-40: Incorrect grip of the clamping lever



Fig. 3-41: Correct grip of the clamping lever

► Maintain a space between knuckles and edge.



### CAUTION

#### Risk of injury from clamping lever

After tightening, the clamping lever may be in a position which can pose a risk of injury for patient and personnel.

- After tightening, turn the clamping lever to a position which poses no risk of injury.



The position of the clamping levers can be changed without releasing the clamping bolt.

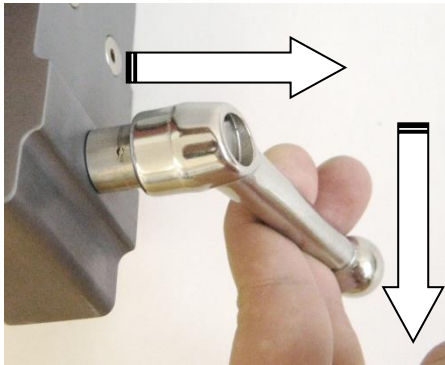

Fig. 3-42: Positioning the clamping lever

- 1 Clamping lever with clamping bolt
- 2 Fixing profile

► First pull the clamping lever away from the fixing profile and then turn into the desired position without turning the clamping bolt.



Fig. 3-43: Clamping lever turned downwards

## ATTENTION

### **Risk of damage to the clamping levers through maneuvering**

Maneuvering the operating table or other operating tables and stretchers may cause a collision. This could damage the clamping levers on the OLH.

- After mounting the OLH on the operating table, take care not to damage the clamping levers when maneuvering.
- Do not use broken or damaged clamping levers.



### WARNING

#### Risk of infection from the boot

Pathogens can accumulate in the boot.

- ▶ Avoid direct contact with the patient.
- ▶ Apply a bandage to avoid direct contact between patient and traction boot during patient preparation and before the traction boot is fitted to the leg to be operated on.
- ▶ Use disposable socks.
- ▶ Clean contaminated traction boots by manually washing with mild detergent and warm water.
- ▶ Replace the boot as needed.



### CAUTION

#### Risk of injury

Patients on operating tables can move even when under anesthesia and sustain injuries.

- ▶ Monitor the patient on the operating table constantly, particularly while they are under anesthesia or restless.
- ▶ During all movements, ensure that the patient is not injured.



### CAUTION

#### Risk of injury when adjusting the traction boot position through crushing on the ball-heel adapter

After releasing the clamping lever "Boot", the ball-heel adapter can fall into a position which may result in fingers being crushed.

- ▶ Hold the Ball-Heel Adapter safely with one hand before releasing the clamping lever.
- ▶ Do not touch the ball-heel slider.

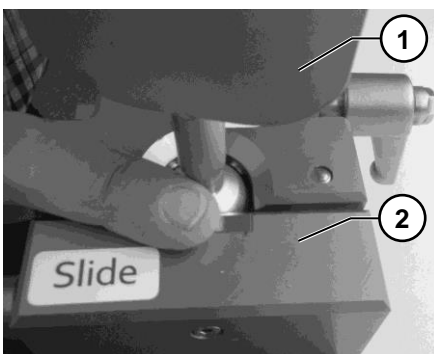

- 1 Ball-heel adapter
- 2 Ball-heel slider

- ▶ Do not touch the ball-heel slider.

Fig. 3-44: Ball-heel adapter

### 3.6.1. Adjusting the extension deck

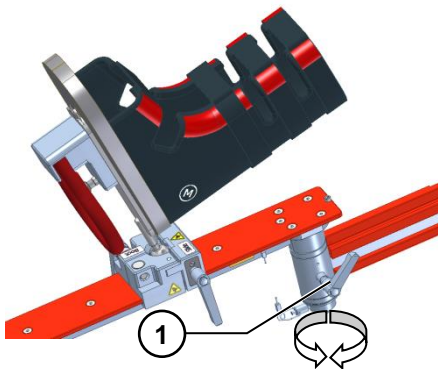

Fig. 3-45: Adjustment options on the extension deck

#### 1 Clamping lever on pivot bearing

The position of the extension deck can be adjusted. The surgeon has to decide in which position they want the extension deck. This also defines in which position they want the hip joint.

The leg can be moved to the inside or outside using the pivot axis of the pivot bearing which changes the lateral angle of the hip joint.

- ▶ Release the clamping lever (1).
- ▶ Move the extension deck to the desired position.
- ▶ Tighten the clamping lever.

### 3.6.2. Adjusting the ball-heel adapter

The ball-heel slider is equipped with two clamping levers. The clamping lever "SLIDE" fixes the position of the ball-heel slider on the extension deck (see chapter 3.3.9).

The clamping lever "BOOT" positions and fixes the ball-heel adapter with the traction boot in the ball-heel slider.

#### Adjusting rotation of the foot:

The ball-heel adapter rotates through the ball joint below the traction boot.



#### CAUTION

##### Risk of injury when adjusting the ball-heel adapter through crushing on the ball-heel adapter

After releasing the clamping lever "Boot", the Ball-Heel Adapter can fall into a position which may result in fingers being crushed.

- ▶ Hold the ball-heel adapter safely with one hand before releasing the clamping lever.
- ▶ Do not touch the ball-heel slider.

Opposite leg holder variants

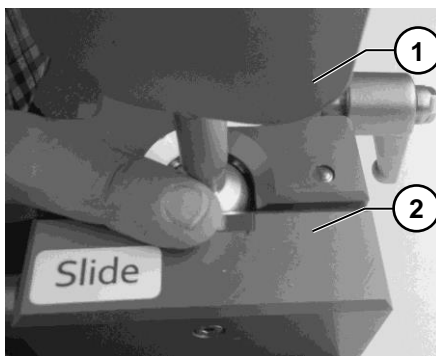

- 1** Ball-heel adapter
- 2** Ball-heel slider

▶ Do not touch the ball-heel slider when adjusting the ball-heel adapter.

Fig. 3-46: Ball-heel adapter and ball-heel slider

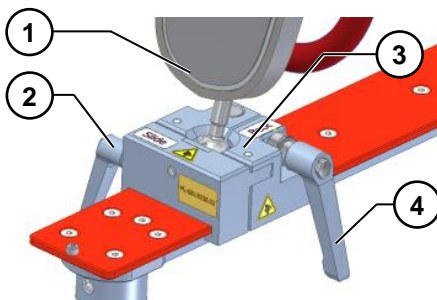

- 1** Ball-heel adapter
- 2** Clamping lever for ball-heel slider position (SLIDE)
- 3** Ball-heel slider
- 4** Clamping lever "Boot" for the ball-heel adapter position

▶ Release the clamping lever "Boot" (4) for the ball-heel adapter (1) and move the ball-heel adapter (1).  
 ▶ Tighten the clamping lever "Boot" (4).

Fig. 3-47: Clamping lever on the ball-heel slider



### 3.7. Troubleshooting

No.	Description of fault	Cause	Corrective action	Personnel
	Extension deck wobbles	Pivot bearing sleeve on the extension rail worn out	Replace pivot bearing sleeve	Engineer
	Ball-heel adapter does not stay in the set position	Ball-heel slider defective	Replace ball-heel slider	Operating personnel
	Clamping lever cannot be tightened	Clamping lever defective	Replace clamping lever	Operating personnel
	Clamping bolt	Spring defective	Replace clamping bolt	Operating personnel
	Locking pin in pivot bearing locking sleeve not fixed	Pawl defective	Replace locking pin with safety loop	Operating personnel

### 3.8. Technical data

	<b>Designation</b>	<b>Opposite Leg Holder US/EU / Denyer</b>	<b>Opposite Leg Holder Denyer Plus</b>
<b>General information</b>	Weight [kg]	8.5	8.7
	Service life [a]	10	10
	Length [mm]	1300	1500
	Width [mm]	200	200
	Height [mm]	400	400
	Max. permitted patient weight [kg]	227	227
<b>Operating conditions</b>	Temperature range [°C]	+10...+40	
	Relative humidity [%]	10...80	
	Air pressure [kPa]	70...106	
<b>Storage conditions</b>	Temperature range [°C]	+5...+40	
	Relative humidity [%]	5...85	
	Air pressure [kPa]	70...106	
<b>Transport conditions</b>	Temperature range [°C]	-25...+60	
	Relative humidity [%]	+5...+85	
	Air pressure [kPa]	70...106	
<b>Medical device class</b>	Class	I	

### 3.9. Components and Accessory Parts



Only use accessories on the opposite leg holder that have been officially approved by ADSM. Contact IOT for any questions.

Order number	Designation	Description (Common Name)	Category <sup>1</sup>
681 3035	OLH #ER	Extension rail	2
681 3041	OLH #ERD	Extension rail Denyer	2
681 3048	OLH #ERDP	Extension rail Denyer plus	2
681 3037	OLH #ED	Extension deck	2
681 3122	OLH #BHS	Ball-heel slider	2
681 3123	OLH #BHA	Ball-heel adapter	2
688 3314	PURIST / OLH – Boot M	Traction boot (Medium)	2
<b>Accessory Parts</b>			
688 3360	PURIST / OLH – Boot S	Traction boot (Small)	2

1) Explanation of replacement part categories:

2 Spare part                                      Structurally similar part which replaces the installed defective part

## 4. Perineal Operative Post (POP)

This product can be attached to many commercial standard operating tables.

### 4.1. Intended use

This product is intended exclusively to ensure counter-traction on hip and leg and to support the femur during surgeries in human medicine in combination with the medical device:

- PURIST Leg Positioning System

### 4.2. Use in contradiction to the intended use

The device must not be used for any other purpose than that indicated in chapter 4.1.



#### **CAUTION**

##### **Hazard from use in contradiction to the intended use**

Use of the device in contradiction to the intended use can lead to dangerous situations. The following are particularly regarded as contradictions to intended use:

- ▶ Use of the device in environments not set up according to the relevant provisions and guidelines for the erection of medical rooms.
  - ▶ Use of a damaged device.
  - ▶ Use of an incorrectly assembled device.
  - ▶ Allowing unqualified personnel to use the device.
-

---

### 4.3. Hazards when used as intended



#### **WARNING**

##### **Risk of contamination**

The pad can contain dangerous germs.

- ▶ Properly disinfect all components before use.
- ▶ Use a new disposable protective cover before each surgery.
- ▶ Replace both pads after approx. ten surgeries.



#### **WARNING**

##### **Risk of injury from tilting of the operating table**

If the product is not mounted on the middle section of the operating table, the operating table may tilt and cause injuries.

- ▶ Only mount the product on the middle section of an operating table.
- ▶ Ensure to follow user instructions of the OR table used. Sometimes flipping the OR table 180 degrees may influence the stability of the OR table.



#### **WARNING**

##### **Risk of injury through radiation**

When using the POP in connection with an X-ray system, the high-frequency electromagnetic radiation may cause radiation hazards.

- ▶ Observe the operating instructions for the X-ray system.
- ▶ Only to be operated by trained personnel.



#### **CAUTION**

##### **Chemical hazard from cleaning agents**

Injuries may occur if the pads are not completely free from cleaning agents after cleaning.

- ▶ Both pads have to be covered with a disposable protective cover before each surgery.
- ▶ Replace both pads after approx. ten surgeries.

**CAUTION****Danger of injuries**

In operations which last several hours, pressure sores can occur – especially with patients who are slimly built or have sensitive skin. The treating doctor is in charge for the correct positioning and padding of the patient.

- ▶ Ensure sufficient padding and correct positioning of patient.
- 

**CAUTION****Risk of injury through incorrect assembly of the POP**

If the POP slides because it was not fixed firmly enough to the operating table, the patient may be moved.

- ▶ Ensure proper position and assembly of the POP.
  - ▶ Check whether the screws were tightened correctly.
- 

**CAUTION****Risk of injury from loose screws**

A loose POP can cause injuries during surgery.

- ▶ Check proper position and assembly of the POP.
  - ▶ Before use, make sure that all wing screws and the star screw have been firmly tightened.
-



**CAUTION**

**Risk of injury from POP breaking**

The POP adjuster will break in case of heavy patients over 227 kg (500 lb.)

- ▶ Use product only for patients of max. 227kg (500 lb.)



**CAUTION**

**Risk of injury from POP breaking**

The POP adjuster will break if counter-traction is applied while femur is supported.

- ▶ Use product only for counter-traction or only to support the femur. To avoid mechanical overload of the unit, do not apply counter-traction while unit is supporting the femur at the same time.

**4.4. Scope of delivery**

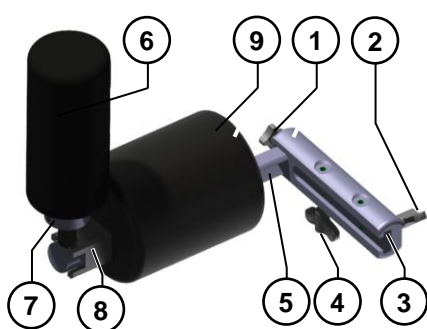

- 1 Star screw
- 2 Wing screw
- 3 POP rail
- 4 Wing screw
- 5 POP adjuster
- 6 POP pad
- 7 POP post
- 8 Femoral support adjuster
- 9 Femoral support pad

Abb. 4-1: POP

## 4.5. Material compatibility

### ATTENTION

#### Corrosive substances can damage the product

Use of corrosive substances for cleaning can damage the product.

- ▶ Only use substances for cleaning which do not corrode the following materials.
- ▶ Observe the cleaning instructions.

Perineal Operative Post	
Component	Materials
Star screw	plastic with metal
Wing screw	plastic with metal
POP rail	metal
POP adjuster	metal, carbon fiber
Perineal post	plastic
Pads	elastomer
Femoral support adjuster	plastic



### CAUTION

#### Chemical hazard from cleaning agents

Injuries may occur if the pads are not completely free from cleaning agents after cleaning.

- ▶ Both pads have to be covered with a disposable protective cover before each surgery.
- ▶ Replace both pads after approx. ten surgeries.



#### 4.6. Load bearing capacity

### ATTENTION

#### Risk of breaking

- ▶ Please check manufacturer's recommendation for maximum load of the accessory rail before attaching the POP to the accessory rail of any table.



Abb. 4-2: POP loads

Minimum requirement for the rail during support of the femur:

- Nominal load for patients weighing max. 227 kg:
  - Reaction force  $F_z = 240$  N
  - Reaction torque  $M_x = 40$  Nm
- Load with safety margins:
  - Reaction force  $F_z = 530$  N
  - Reaction torque  $M_x = 90$  Nm

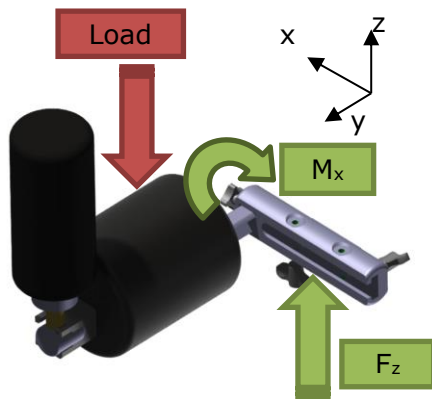

### CAUTION

#### Risk of injury from POP breaking

The POP adjuster will break in case of heavy patients over 227 kg. (500 lb.)

- ▶ Use product only for patients of max. 227 kg (500 lb.)



Abb. 4-3: Counter-traction

Minimum requirement for the rail during counter-traction:

- Nominal load (traction) = 450N:
  - Counter-traction  $F_x = 450\text{ N}$
  - Reaction torque  $M_y = 155\text{ Nm}$
  - Reaction torque  $M_z = 135\text{ Nm}$
  
- Load with safety:
  - Counter-traction  $F_x = 1800\text{ N}$
  - Reaction torque  $M_y = 620\text{ Nm}$
  - Reaction torque  $M_z = 540\text{ Nm}$

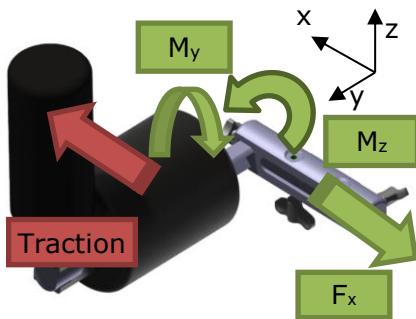

## CAUTION

### Risk of injury from POP breaking

The POP adjuster will break if counter-traction is applied while femur is supported.

- ▶ Use product only for counter-traction or only to support the femur. To avoid mechanical overload of the unit, do not apply counter-traction while unit is supporting the femur at the same time.

#### 4.7. Preparation

- ▶ Ensure that all accessory parts required for mounting the product are available.



#### **WARNING**

##### **Risk of injury from tilting of the operating table**

If the product is not mounted on the middle section of the operating table, the operating table may tilt and cause injuries.

- ▶ Only mount the product on the middle section of an operating table.
  - ▶ Ensure to follow user instructions of the OR table used. Sometimes flipping the OR table 180 degrees may influence the stability of the OR table. If the table is flipped 180 degrees, the head section and leg sections shown in the figures below are interchangeable.
-

### 4.7.1. Removing the leg section of the operating table

► Remove the leg section (1) of the operating table.

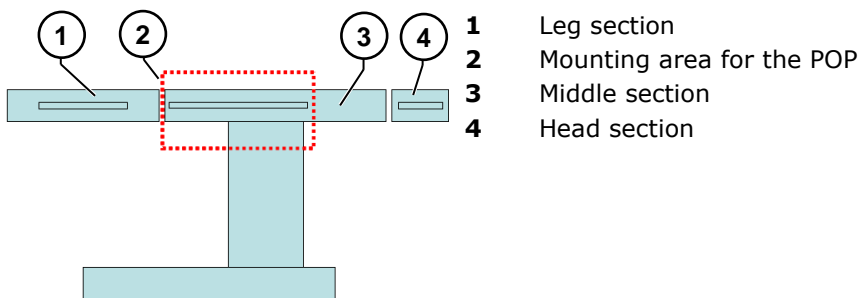

Fig. 4-4: Operating table with leg section

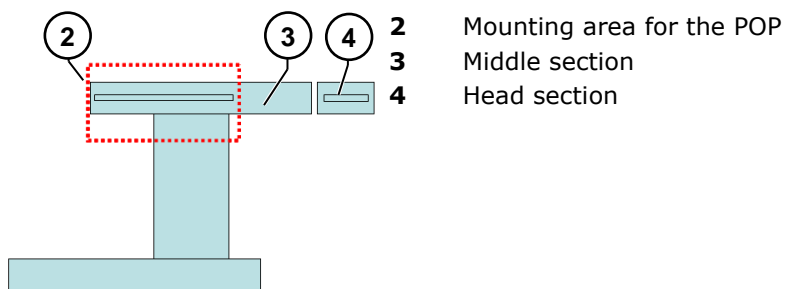
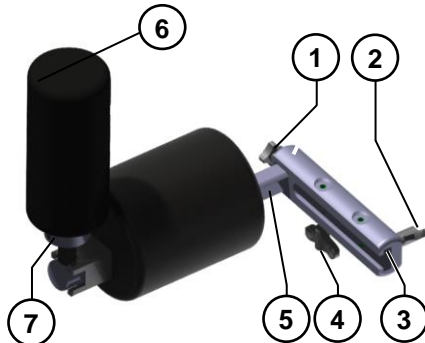

Fig. 4-5: Operating table without leg section

#### 4.8. Mounting the perineal operative post



- 1 Star screw
- 2 Wing screw
- 3 POP rail
- 4 Wing screw
- 5 POP adjuster
- 6 POP pad
- 7 POP post

Abb. 4-6: POP

- ▶ Unscrew the wing screws (2,4) and push the POP rail (3) on the accessory rail of the operating table.
- ▶ Tighten the wing screws (2,4) and fasten the POP rail (3) to the accessory rail of the operating table.
- ▶ Unscrew the star screw (1) and push the POP adjuster (5) into the POP rail (3) until the post is at the center of the operating table.
- ▶ Tighten the star screw (1) and fasten the POP adjuster (5).
- ▶ Slide the POP pad (6) onto the POP post (7).



#### CAUTION

##### Risk of injury through incorrect assembly of the POP

If the POP slides because it was not fixed firmly enough to the operating table, the patient may be moved.

- ▶ Ensure proper position and assembly of the POP.
- ▶ Check whether the screws were tightened correctly.



#### CAUTION

##### Risk of injury from loose screws

A loose POP can cause injuries during surgery.

- ▶ Check proper position and assembly of the POP.
- ▶ Before use, make sure that all wing screws and the star screw have been firmly tightened.



#### WARNING

##### Risk of contamination

The pads can contain dangerous germs.

- ▶ Properly disinfect all components before use.
- ▶ Use a new disposable protective cover before each surgery.
- ▶ Replace both pads after approx. ten surgeries.

**CAUTION****Danger of injuries**

In operations which last several hours, pressure sores can occur – especially with patients who are slimly built or have sensitive skin. The treating doctor is in charge for the correct positioning and padding of the patient.

- ▶ Ensure sufficient padding and correct positioning of patient.
- 

**Note**

Replace pads after about ten operations.

---

**Note**

POP can be used without the femoral support to ensure counter-traction.

---

## 4.9. Adjust the Femoral Support



Abb. 4-7: POP

- 1 POP rail
- 2 POP adjuster
- 3 Femoral support adjuster
- 4 Femoral support pad

- ▶ Pull femoral support (3, 4) towards POP rail (1) until femoral support can be turned.
- ▶ Turn femoral support (3, 4) until desired padding height has been reached.
- ▶ Push femoral support (3,4) towards POP post (2) until position is locked again.

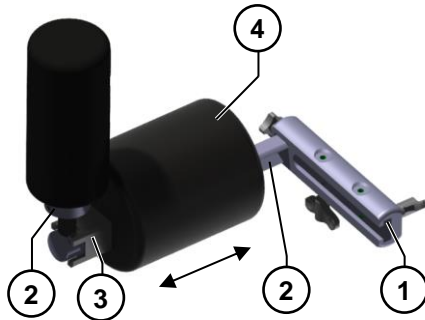

### WARNING

#### Risk of contamination

The pads can contain dangerous germs.

- ▶ Properly disinfect all components before use.
- ▶ Use a new disposable protective cover before each surgery.
- ▶ Replace both pads after approx. ten surgeries.



### CAUTION

#### Danger of injuries

In operations which last several hours, pressure sores can occur – especially with patients who are slimly built or have sensitive skin. The treating doctor is in charge for the correct positioning and padding of the patient.

- ▶ Ensure sufficient padding and correct positioning of patient.



#### Note

Replace pads after about ten operations.

#### 4.10. Technical data POP

	<b>Designation</b>	<b>Perineal Operative Post</b>
<b>General information</b>	Weight [kg]	3.1
	Service life [a]	10
	Length [mm]	300
	Width [mm]	300
	Height [mm]	300
	Max. permitted patient weight [kg]	227
<b>Working conditions</b>	Temperature range [°C]	+10...+40
	Relative humidity [%]	10...80
	Air pressure [kPa]	70...106
<b>Storage conditions</b>	Temperature range [°C]	+5...+40
	Relative humidity [%]	5...85
	Air pressure [kPa]	70...106
<b>Transport conditions</b>	Temperature range [°C]	-25...+60
	Relative humidity [%]	+5...+85
	Air pressure [kPa]	70...106
<b>Medical Device Class</b>	Class	I



#### 4.11. Wear parts

Reference	Description
<b>681 3136</b>	Pad for the POP / Tabletop
<b>688 3135</b>	Femoral Support Pad

- Wear part: Part which is destroyed by mechanical stress in the surface

## 5. Maintenance/service

A list of the available replacement parts and consumables can be obtained from the distributor.

### 5.1. Important information

As with every technical device, these products also require

- Proper operation in accordance with this user manual
- Regular checks by the user
- Regular maintenance and repair

These precautionary measures will allow you to keep the device in a functioning and safe operating condition. The operating company of a surgical facility is obligated to comply with this based on the accident prevention regulations, the Medical Devices Directive and other regulations.

Maintenance consists of

- Inspection work which can be carried out by the operating company.
- Maintenance tasks that are carried out by persons expressly authorized within the framework of service agreements or through service contracts.
- Cleaning work carried out by personnel instructed by the operating company.
- Disinfection tasks carried out by personnel instructed by the operating company.

Maintenance work may only be carried out by specially trained or authorized personnel.

## 5.2. Checks by the operating company

The operating company has to check the device for obvious defects. If functional defects or other deviations from normal operating behavior occur, the operating company may no longer operate the device and has to inform customer service. Put the device back into operation only after repair is complete. Operation using defective components can result in increased safety risks.



### CAUTION

#### Risk of injury from defective components

Defective components pose a risk of injury.

- ▶ Replace defective components only with original spare parts.

## 5.3. Maintenance plan

The following sections describe tasks which are required for optimum operation of the device without malfunctions.

If regular checks reveal increased wear, shorten the required maintenance intervals according to the actual signs of wear. If you have any questions about maintenance tasks and intervals, please contact the distributor; see contact data on page 2.

Interval	Maintenance task	Personnel
annually	Technical check of the device	Medical technician of the operating company
as needed	Replace traction boot	Medical technician of the operating company
as needed	Tighten bolts	Medical technician of the operating company
before each use	Check accessory rails on the operating table for defects	Qualified medical personnel
before each use	Check tight seating of the screws on the rails of the operating table	Qualified medical personnel
before each use	Clean and disinfect the device	Qualified medical personnel

## 5.4. Maintenance work

### 5.4.1. Cleaning



#### **WARNING**

##### **Risk of contamination**

These devices are not shipped in sterile condition.

- ▶ Please clean and disinfect the devices according to the procedures approved by your organization.
- 

Please take care in your selection of a cleaning agent:

- ▶ Clean plastic surfaces only with soapy water. The use of any other agents, such as those with high alcohol content, will cause the material to become dull or brittle.
- ▶ Do not use corrosives, solvents or grinding agents for cleaning or polishing.

Take care about cleaning:

Use only a moist cloth and mild cleansers to wipe painted parts and aluminum surfaces and dry with a dry, lint-free cloth.

### 5.4.2. Disinfection

The methods used for disinfecting have to comply with the valid legal provisions and guidelines for disinfecting and for explosion protection.

Do not use any corrosives, solvents or gaseous disinfectants.

- The products have to be disinfected according to instructions before each surgery.

## 6. Transport, storage, and disposal

### 6.1. Transporting while assembled

#### ATTENTION

##### Risk of damage from loose screws

If the product is transported while assembled, screws may become loosened which can result in damage.

- ▶ Do not transport the product while assembled.
  - ▶ Always check tight seating of screws.
- 

### 6.2. Decontamination before shipping



#### WARNING

##### Health risk from contaminated device

Dangerous pathogens may be present on the device.

- ▶ Clean and disinfect the device according to the procedures approved by your organization before shipping.
- 

### 6.3. Storage

#### ATTENTION

##### Risk of damage from incorrect storage

Incorrectly storage of the product may result in damage.

- ▶ Store the product according to the storage conditions (see chapter Technical data).
- 

### 6.4. Disposal

Please ensure to properly dispose of or recycle the device and/or that the pertinent legal requirements are observed. For this reason, this product must not be disposed of in ordinary industrial or household waste. Dispose of the individual component parts separately.

The distributor can provide support for proper disposal if necessary.

## 7. Revision

Version	Release Date	Company	Reason for Change
Rev01	15/10/2020	ADSM	Creation

