

MAKO[®]

stryker

Instrument Cleaning and Sterilization Guide

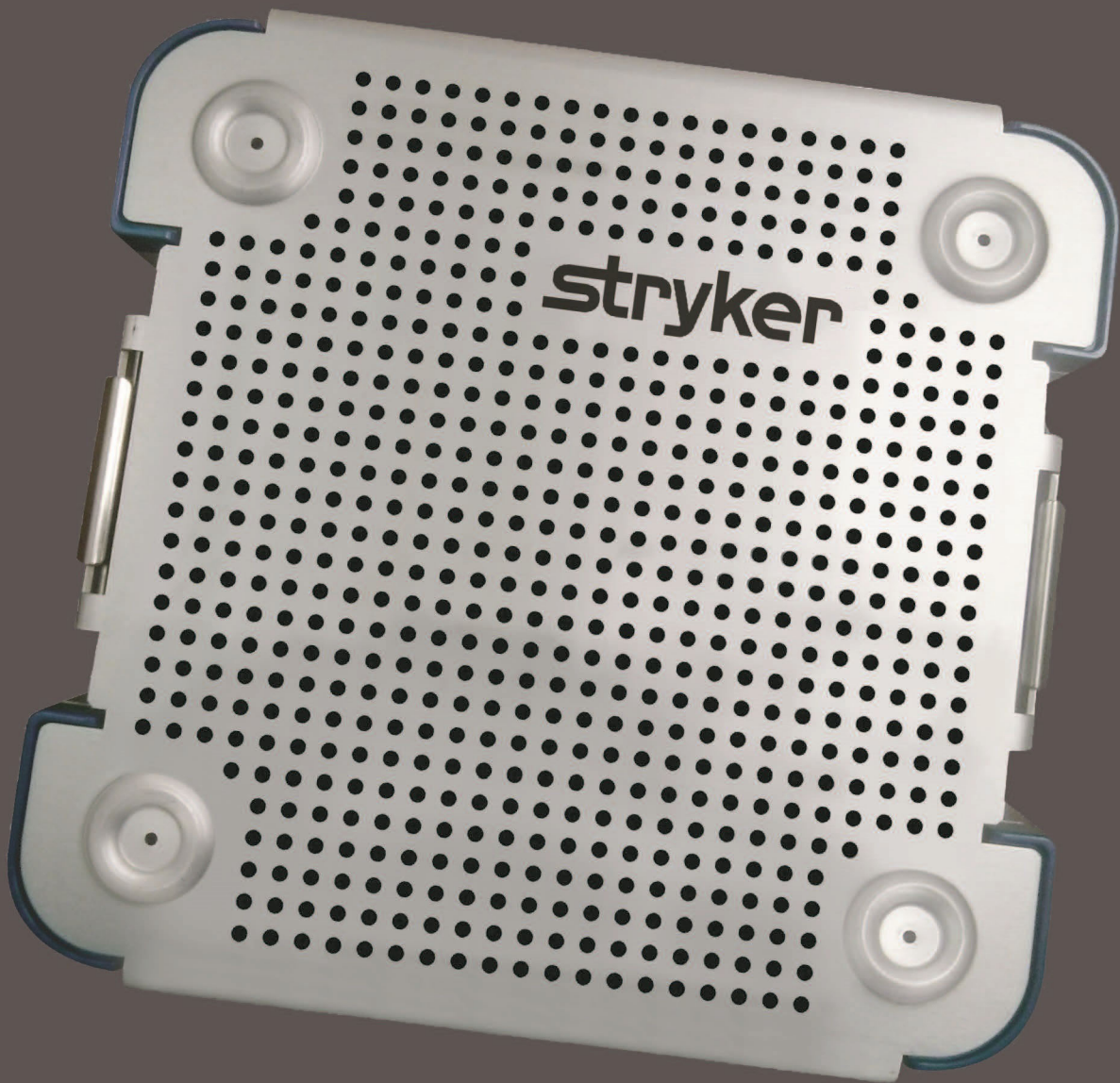


TABLE OF CONTENTS

A. INTRODUCTION.....	1
B. DOCUMENT REFERENCES.....	2
C. INITIAL USE OF INSTRUMENTS	3
D. INSTRUMENT MATERIALS.....	4
E. STERILE DISPOSABLES	8
F. PRE-CLEANING CONSIDERATIONS.....	12
G. INSTRUMENT CLEANING GUIDELINES.....	22
H. STERILIZATION TRAYS.....	28
I. STERILIZATION GUIDELINES.....	28
J. REUSABILITY	30
K. CONDITIONS FOR STORAGE	30
APPENDIX A. DISINFECTION STRATEGY.....	31
APPENDIX B. EXTENDED DRY TIME TABLE	33

A. INTRODUCTION

1. About This Manual

This manual describes the cleaning and sterilization for instrumentation used with Mako Hip, and Knee applications, as well as the Stryker Leg Positioner. The information provided herein, in conjunction with the application of a predetermined customer disinfection strategy, allows for cleaning and sterilization of reusable medical instrumentation in accordance with the applicable domestic and international guidelines.

2. Support / Feedback

Customer Service +1 (855) 303-6256
www.stryker.com

3. Copyrights and Trademarks

The content of this manual is protected under applicable copyright and trademark laws. You agree that you will not copy, distribute, republish, display, post, transmit or modify any content in this manual without Stryker's prior permission. Any images displayed in this manual are the property of their respective copyright owners. Any reproduction, replication, modification or distribution of any art images in this manual is prohibited. The third-party trademarks in this manual are proprietary to their respective owners. These companies or their agents have granted Stryker the right to use their trademarks.



Refer to product label for CE mark status and legal manufacturer. The CE mark is only valid if found on the product label.

4. Governing Law

Any legal action or proceeding related to this manual or the information contained in it shall be brought exclusively in a court in Bergen County, New Jersey, and shall be governed by the laws of the State of New Jersey, without regard to conflicts of laws principles.

5. Manufacturer



MAKO Surgical Corp.
3365 Enterprise Avenue
Weston, FL 33331 USA

6. Symbols used in this manual



Useful information or clarification.



Indicates situations or actions which could cause damage to equipment and/or result in user/patient injury.

B. DOCUMENT REFERENCES



There are no user serviceable parts in the Mako, refer to your Mako (Stryker) authorized personnel for service.







In case of serious incident, please notify the Manufacturer and Competent Authority in your region.

The following external references help to develop and maintain the recommended information:

BS EN ISO15883 Sections 1-7	EN 554
BS EN ISO17664	EN 556-1
BS EN ISO17665 Sections 1-3	EN 556-2
ANSI/AAMI ST79	HTM01-01 Parts A-D
ANSI/AAMI ST58	United States/European/Japanese Pharmacopoeia (USP/EP/JP)
ANSI/AAMI ST77	Corin Cleaning of Surgical Instruments
ANSI/AAMI ST8	Corin Instructions for Re-Processing Reusable Devices

Additional information about electronic Instructions for Use (eIFU) can be found below.

  ifu.stryker.com	 <small>Free paper copy within 7 days / FR / DE / ES / IT / PT / SV / DA / FI / NL / EL / NO / JA / PL / KO / ZH / RO / LT / BG / CS</small>	
	 +800 135 79 135	
Adobe® Reader®	AR AT AU BE BG BR CH CO CY CZ DE DK ES FI FR GB HU IE IL IT LU LV NL NO NZ PL PT RU SE SI UY AD AE BH BM CN DO DZ EG HK IN IQ JO JP KR KW KZ LB LY MX MY OM PR QA RS SA SD TH TN TW TZ UA ZA +31 20 794 7071	BR 0800 591 1055 CA +1 855 805 8539 CL 800 914 248 EE 0800 0100567 GR 00800 161 2205 7799 HR 0800 804 804 IS 800 8996 LI +31 20 796 5692 LT 8800 30728 MT +31 20 796 5693 RO 0800 895 084 SG 800 101 3366 SK 0800 606 287 TR 00800 142 064 866 US +1 855 236 0910 VN 122 80297

C. INITIAL USE OF INSTRUMENTS

Remove all packaging material from instruments. Open all instrument kits and confirm internal packaging materials are removed.

Probe and Array Preparation

Remove plastic caps only. DO NOT disassemble probe tip or posts from probe bodies and posts from array bodies.

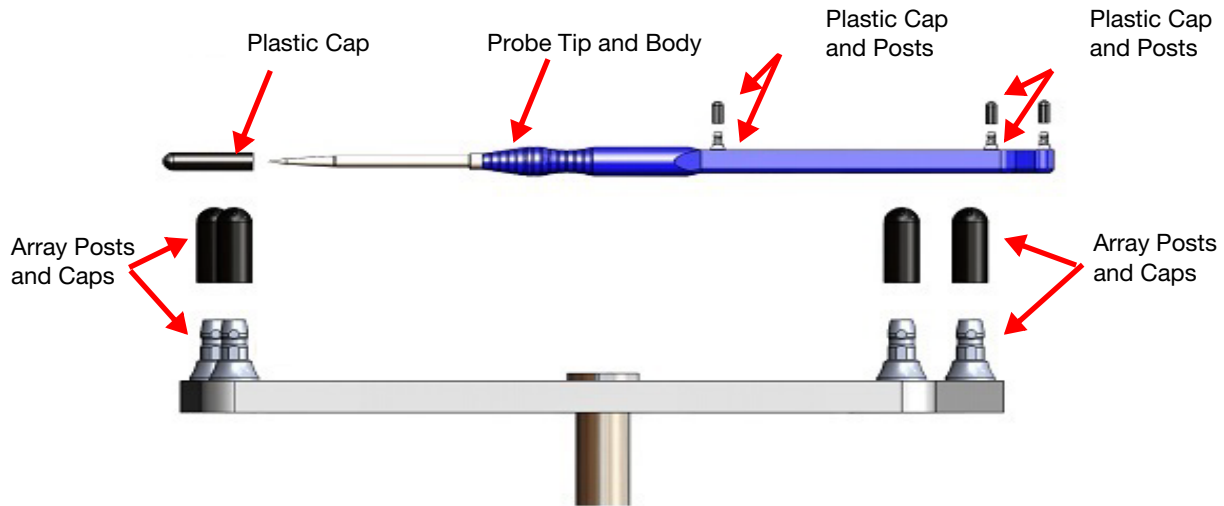


Figure 1. Removal of Packaging Materials



Orthopaedic surgical instruments generally have a long service life; however, mishandling or inadequate protection can quickly diminish their life expectancy. Mako surgical instruments have the ability to function as intended and are considered acceptable and verified over an expected lifetime of 250 surgeries in a 1-year period without loss of function. Instruments which no longer perform properly because of long use, mishandling, or improper care should be returned to MAKO Surgical Corp. (Stryker) to be discarded. Notify your Mako Representative of any instrument problems.

Safe Disposal

If a device is being returned for evaluation, please contact your local Mako representative for shipping and handling information. If the device is not being returned to MAKO Surgical Corp., it is to be disposed of in accordance with applicable laws, rules, and regulations for the disposal of biohazardous waste. Follow all guidelines for biohazardous waste in accordance with the Centers for Disease Control and Prevention guidelines as well as applicable federal, national, state and local regulations.

D. INSTRUMENT MATERIALS

Table 1. Mako Knee Instrument Kit

Instrument	Material
2-Pin Clamp	Stainless Steel
Angled Saw Attachment	Stainless Steel, Ceramic
Array Stabilizer (3.2 short or 4.0 long)	Stainless Steel
Blunt Probe	Stainless Steel, Aluminum
Burr Guard Assembly	Stainless Steel, Ceramic
Cement Removal Tool	Stainless Steel
Femoral Trial Slaphammer	Stainless Steel
High Speed Rotary Attachment	Stainless Steel, Ceramic
Knee Checkpoint Driver	Silicone, Stainless Steel
Knee End Effector Array	Stainless Steel, Aluminum
Knee Femoral Array	Stainless Steel, Aluminum
Knee Tensioner	Stainless Steel
Knee Tibial Array	Stainless Steel, Aluminum
Lamina Spreader	Stainless Steel
Mako (RIO) System Quick Connect Base Array	Stainless Steel, Aluminum
MICS Attachment Wrench	Stainless Steel
MICS Handpiece	Stainless Steel, Aluminum, PPSU, Silicone
Pelvic Array Adaptor	Stainless Steel, Nitronic 60
Planar Probe	Stainless Steel
Registration Tool	Stainless Steel
Right Angle Saw Attachment	Stainless Steel, Titanium, Viton, Ceramic
Sharp Probe	Stainless Steel, Aluminum
Spacer Block (16/18 mm, 20/22 mm)	Stainless Steel
Spacer Paddle (1 mm x 2 mm, 3 mm x 4 mm, 5 mm x 6 mm)	Stainless Steel
Spacer Shim, 5 mm	Polyphenylsulfone (PPSU)
Square Drill Adaptor	Stainless Steel
Square Driver	Silicone, Stainless Steel
Straight Saw Attachment (Sagittal)	Stainless Steel, Titanium, Viton, Ceramic

Table 2. Mako THA Instrument Kit

Instrument	Material
2-Pin Clamp	Stainless Steel
3-Pin Pelvic Clamp	Stainless Steel
Accolade II 127° or 132°, 27mm Neck Trial	Stainless Steel
Accolade II 127° or 132°, 30mm Neck Trial	Stainless Steel

Instrument	Material
Accolade II 127° or 132°, 35mm Neck Trial	Stainless Steel
Accolade II 127° or 132°, 37mm Neck Trial	Stainless Steel
Accolade II 127° or 132°, 40mm Neck Trial	Stainless Steel
Acetabular Reamer Case Base Assembly	Stainless Steel
Anato Neutral Neck Trial, Anteverted	Stainless Steel
Anato Neutral Neck Trial, Left	Stainless Steel
Anato Neutral Neck Trial, Right	Stainless Steel
Bone Pin Adaptor	Stainless Steel
Broach Array (V40 Postero-Lateral and Antero-Lateral)	Stainless Steel, Aluminum and Polyphenylsulfone
Checkpoint Driver (Pelvic)	Stainless Steel
Crest Pin Clamp	Stainless Steel
Crest Drill guide	Stainless Steel
Cup Impaction Platform	Stainless Steel and Aluminum
Drivers and Handle Attachments	Stainless Steel, Aluminum and Silicon
Femoral Array	Stainless Steel and Aluminum
Femoral Array Extended Post	Stainless Steel
Fixed Driver Handle	Stainless Steel, Silicone
Hex Driver, 3.5mm	Stainless Steel
Hip End Effector (Parallel and Variable Angle)	Stainless Steel, Aluminum
Hip Probe	Stainless Steel, Aluminum
Mako (Trident RIO) Inline-Offset Shell Impactor	Stainless Steel
Mako Integrated Cutting System (MICS)	Stainless Steel, Aluminum, PPSU, Silicone
Mako Offset Reamer Handle	Stainless Steel
Mako (RESTORIS RIO) Shell Impaction Platform	Stainless Steel
Mako Straight Reamer Handle	Stainless Steel
Mako (Trident RIO) Straight Shell Impactor	Stainless Steel
Mako (RIO) System Quick Connect Base Array	Stainless Steel, Aluminum
MicroAire Adaptor	Stainless Steel
MicroAire 7005 Series Drill/Reamer	Stainless Steel and Aluminum
MicroAire Power Cable	Silicone
MICS Adapter Cover	Polyphenylsulfone
MICS Reamer Attachment	Stainless Steel, Aluminum, PEEK
Pelvic Array	Stainless Steel and Aluminum
Pelvic Array Adaptor	Stainless Steel and Aluminum
Pelvic Checkpoint Driver	Stainless Steel, Silicone
Reamer Handle Sleeve	PTFE
Registration Array (RIO)	Stainless Steel and Aluminum

Instrument	Material
Screw Holding Forceps	Stainless Steel
Square Driver	Stainless Steel

Table 3. Mako PKA Instrument Kit

Instrument	Material
2-Pin Clamp	Stainless Steel
Anterior Cut Reference Guide	304, 316, 410 or 17-4 PH Stainless Steel
Array Stabilizer (3.2 short or 4.0 long)	Stainless Steel
Blunt Introducer	Stainless Steel
Blunt Probe	Aluminum, Stainless Steel
Burr Guard Assembly	Stainless Steel, PEEK
Caddy Saw Guide (RESTORICS MCK PFJ)	17-4 PH Stainless Steel
Cement Clamp Jaw	PPSU (Radel R5550)
Cement Removal Tool	Stainless Steel
Clamp Assembly, Patella Resection	17-4 PH Stainless Steel, 316L Stainless Steel
Clamp, Patella Saw Guide (8.25 mm, 9.25 mm, 10.25 mm)	17-4 PH Stainless Steel
Collet Nut	Stainless Steel
Depth Gauge	Stainless Steel
Double Angle Collet	Stainless Steel
Double Barrel Drill Guide	Aluminum, Stainless Steel
Femoral Impactor	17-4 PH Stainless Steel, Acetyl copolymer or PPSU (Radel R5500)
Femoral Peg Drill	17-4 PH Stainless Steel
Femoral Trial Slaphammer	Stainless Steel
Goelet Retractor	300 Series Stainless Steel
High Speed Rotary Attachment	Aluminum, Stainless Steel, PEEK
Inlay Impactor, Tibial Insert Assembly	17-4 PH Stainless Steel
Knee Checkpoint Driver	Aluminum, Stainless Steel
Knee End Effector	N3971, Silicone, Stainless Steel
Knee End Effector Array	Aluminum, Stainless Steel
Knee Femoral Array	Aluminum, Stainless Steel
Knee Tibial Array	Aluminum, Stainless Steel
Mako (RIO) System Quick Connect Base Array	Stainless Steel, Aluminum
MICS Attachment Wrench	Stainless Steel
MICS Handpiece	Stainless Steel, Aluminum, PPSU, Silicone
Onlay Insert Extractor	316, 420, 17-4 or 18-8 PH Stainless Steel
Onlay Insert Impactor	17-4 PH Stainless Steel, Acetyl Copolymer

Instrument	Material
Patella Impactor	17-4 PH Stainless Steel, Acetyl Copolymer or PPSU (Radel R5500)
Patella Protector	300 Series Stainless Steel
Pelvic Array Adaptor	Stainless Steel
Registration Tool	Stainless Steel
Sagittal Saw Attachment	Aluminum, Stainless Steel, Viton Rubber, Titanium
Sharp Probe	Aluminum, Stainless Steel
Short Collet Nut Wrench	Stainless Steel
Spacer Paddles (1mm x 2mm, 3mm x 4mm, 5 mm x 6 mm)	Stainless Steel
Square Drill Adapter	Stainless Steel
Square Driver	Silicone, Stainless Steel
Townley Caliper (4")	300 and 400 Series Stainless Steel

Table 4. Stryker Leg Positioner Instrument Kit

Instrument	Material
Rail Clamp	Aluminum, Stainless Steel, Bronze
Base Bar	Carbon Fiber, Aluminum, Stainless Steel
Sled	Aluminum, Stainless Steel, Bronze
Boot	Carbon Fiber, Aluminum, Stainless Steel, Bronze, Ceramic, PEEK
Extension Bar	Carbon Fiber, Aluminum, Stainless Steel, Bronze
Short Antler	Aluminum
Long Antler	Stainless Steel
Bent Hohmann Retractor	Stainless Steel
Rake Retractor	Stainless Steel
Smiley Retractor	Stainless Steel
PCL Retractor	Stainless Steel
Patella Retractor	Stainless Steel

E. STERILE DISPOSABLES








Table 5 lists items that are designated as disposable and should be used for a single Mako surgery.



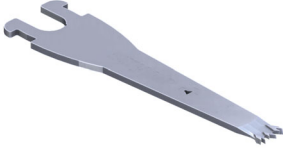



Disposables should not be cleaned or sterilized.

Table 5. Disposable Instruments Mako TKA, THA, PKA, and Leg Positioner

TKA		
Disposable	Image	Material
Mako (RIO) Drape Kit		LDPE, HDPE, Tyvek, PE film, EMA
Mako Blade (Standard, Narrow)		420 Stainless Steel
VIZADISC		Polycarbonate Resin, reflective material
Knee Femoral Checkpoint		316L Stainless Steel
Knee Tibial Checkpoint		316L Stainless Steel
Bone Pins (3.2 mm, 4.0 mm)		316L Stainless Steel

THA		
Disposable	Image	Material
Mako (RIO) Drape Kit		LDPE, HDPE, Tyvek, PE film, EMA
Checkpoint 3.5 Hex X 15mm		316LVM Stainless Steel
Checkpoint 3.5mm Hex, IMPACTION		316L Stainless Steel
Tibial Checkpoint		316LVM Stainless Steel
Cortical Screw		316LVM Stainless Steel
4.0 Bone Pins (80, 110, 140, 170mm lengths)		316LVM Stainless Steel
VIZADISC Hip Procedure Tracking Kit		Polycarbonate Resin, reflective material

PKA		
Disposable	Image	Material
Mako (RIO) Drape Kit		LDPE, HDPE, Tyvek, PE film, EMA
6mm Fluted Ball Burr		M2 Tool Steel
Mako (RIO) System Irrigation Tube	N/A	Tygon (Latex Free)
Irrigation Clip HD (Anspach)	N/A	304 Stainless Steel / PEEK
VIZADISC		Polycarbonate Resin, reflective material
Knee Femoral Checkpoint		316L Stainless Steel
Knee Tibial Checkpoint		316L Stainless Steel
Bone Pins 3.2mm/4.0mm		316L Stainless Steel
MICS Irrigation Clip		316LVM Stainless Steel
Mako Ball Burr (116041-57)		440C Stainless Steel
Mako Ball Burr (110135)		M42 Tool Steel

PKA		
Disposable	Image	Material
Mako Saw Blade (Narrow)		440C Stainless Steel
Leg Positioner		
Disposable	Image	Material
Silicone Retractor Cord		Platinum Silicone 6.35mm Dia x 610mm Long
Foam Pad		9.5mm Thick Gray Polyurethane Open Cell Memory Foam
Coban Wrap		Black Coban Adhesive Tape

F. PRE-CLEANING CONSIDERATIONS

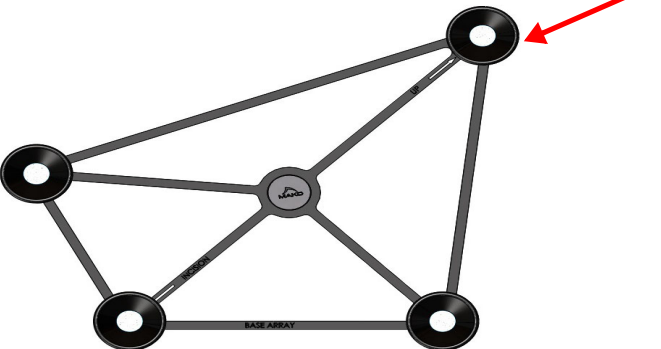

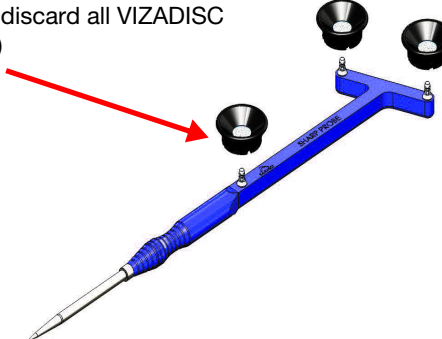
Any Mako instrumentation that has patient contact in a surgical procedure requires cleaning and sterilization. Prior to initiating cleaning and disinfection, a user/facility appropriate disinfection strategy should be chosen from Appendix A. The chosen strategy should be based on the disinfection agents and equipment available.

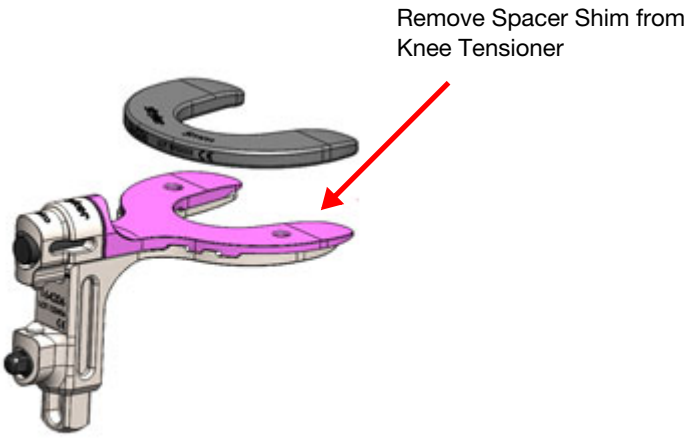
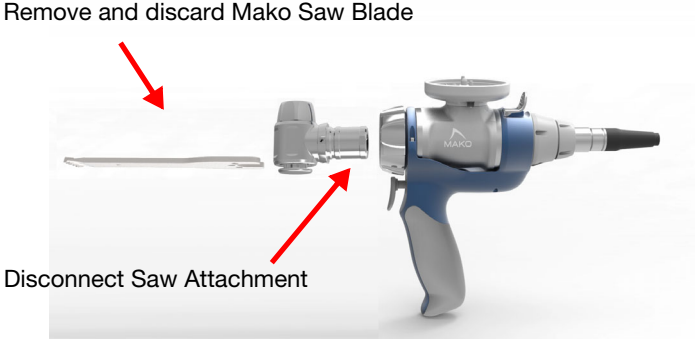
Before cleaning, some instruments may need to be disassembled.

- Remove and discard all disposables (VIZADISCs, bone pins, etc.) from instruments prior to cleaning. When removing VIZADISCs, gently twist the VIZADISCs clockwise and pull.
- Disassemble instruments with multiple components before cleaning; reference Table 6. Some instruments are not intended to be disassembled, reference Table 6.
- Before starting the cleaning and sterilization process, visually inspect all instruments for damage. Remove any damaged parts from use and return them to MAKO Surgical Corp. after cleaning and sterilizing.

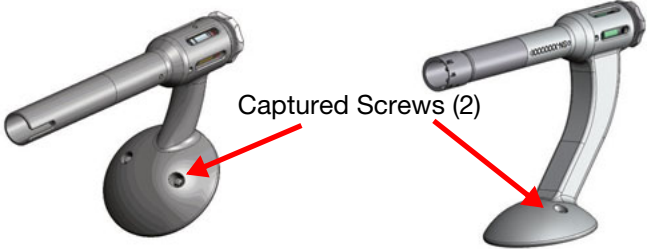

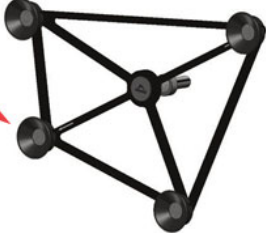


Table 6. Instrument Disassembly


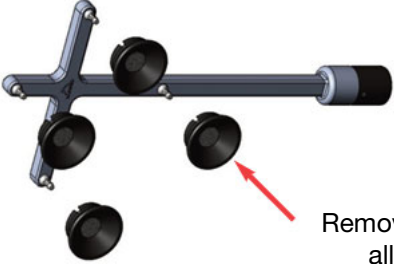
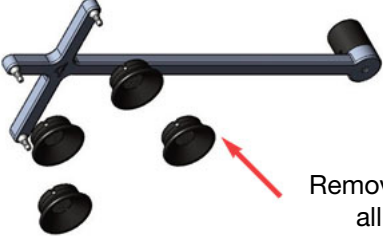
TKA	
Part Name	Image
Knee Femoral and Knee Tibial Array Assembly	

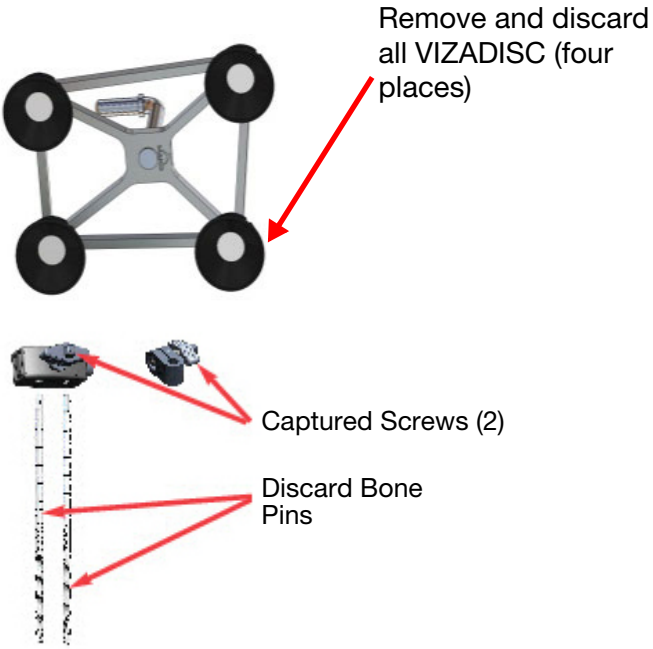
TKA	
Part Name	Image
RIO (Mako) Base Array Assembly	<p style="text-align: right;">Remove and discard all VIZADISC (four places)</p> 
Knee End Effector Array Assembly	<p style="text-align: right;">Remove and discard all VIZADISC (four places)</p> <p>Disassemble Screw</p> 
Sharp and Blunt Probes	<p>Remove and discard all VIZADISC (three places)</p> 

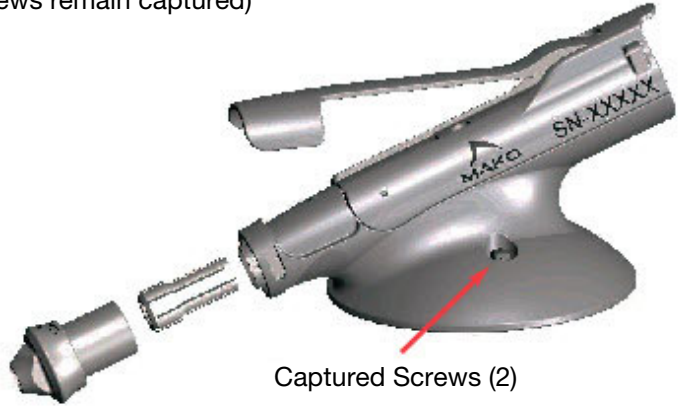
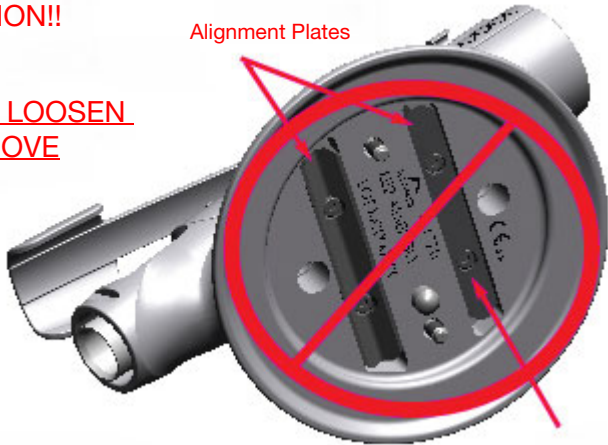
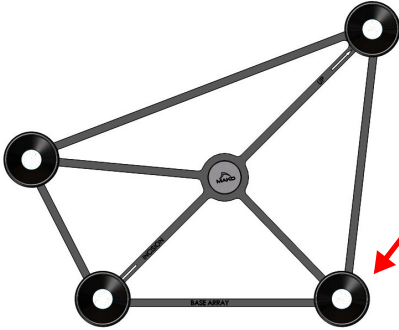
TKA	
Part Name	Image
Knee Tensioner and Spacer Shim	 <p>Remove Spacer Shim from Knee Tensioner</p>
MICS Handpiece Assembly	 <p>Remove and discard Mako Saw Blade</p> <p>Disconnect Saw Attachment</p>

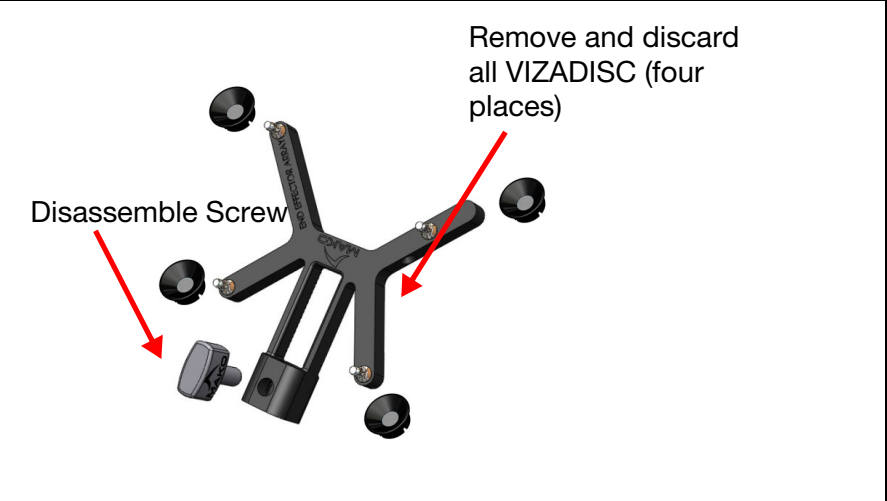
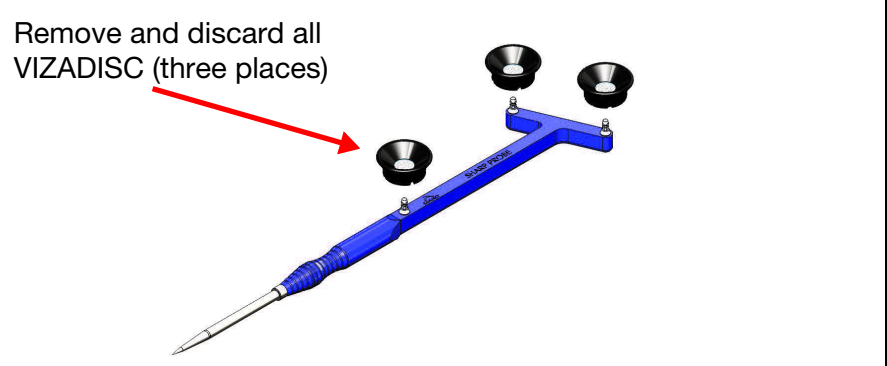
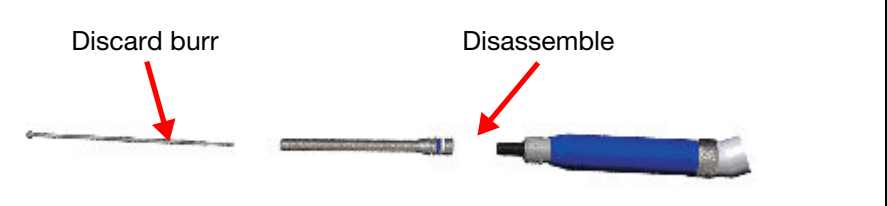
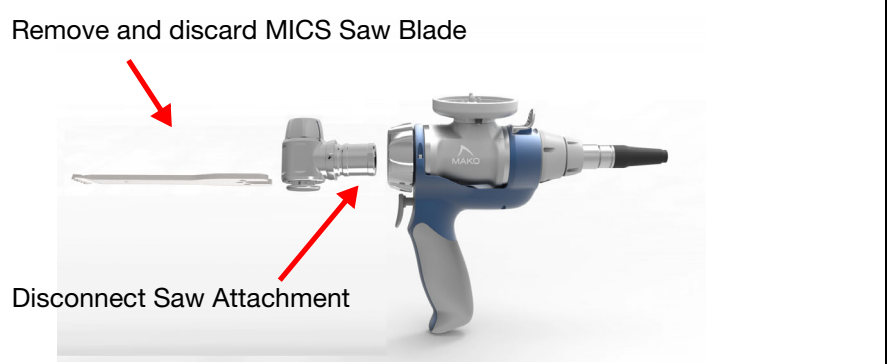
THA	
Part Name	Image
<p>Pelvic Array Assembly (3-Pin Clamp)</p>	<p>Remove and discard all VIZADISC</p> <p>Thumbscrew</p> <p>Array Clamp</p> <p>Thumbscrew</p> <p>Discard All Bone Pins</p>
<p>Pelvic Array Assembly (O Clamp) Optional</p>	<p>Remove and discard all VIZADISC</p> <p>Pelvic Array</p> <p>O Clamp</p> <p>Discard All Bone Pins</p>

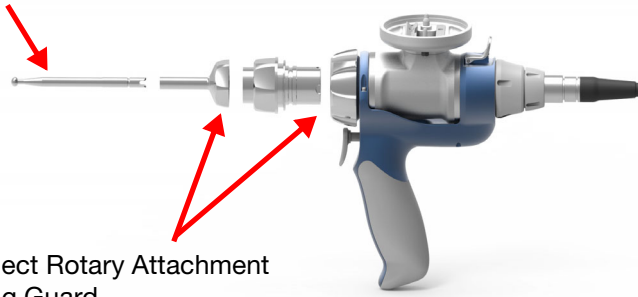
THA	
Part Name	Image
Hip End Effector and Variable End Effector Assembly	 <p>Captured Screws (2)</p>
Femoral Array Assembly	 <p>Remove and discard all VIZADISC</p>
RIO Base Array	 <p>Remove and discard all VIZADISC</p>
RIO Registration Array	 <p>Remove and discard all VIZADISC</p>
Hip Probe	 <p>Remove and discard all VIZADISC</p>

THA	
Part Name	Image
Straight Reamer Handle Assembly	 <p>Push up and turn clockwise to unlock for sterilization</p>
Broach Array Postero-Lateral	 <p>Remove and discard all VIZADISC</p>
Broach Array Antero-Lateral	 <p>Remove and discard all VIZADISC</p>

PKA	
Part Name	Image
Femoral and Tibial Array Assembly	 <p>Remove and discard all VIZADISC (four places)</p> <p>Captured Screws (2)</p> <p>Discard Bone Pins</p> <p>The diagram shows the PKA Femoral and Tibial Array Assembly. It consists of a central grey frame with four black circular VIZADISC components. Below the frame are two long, thin bone pins. Two captured screws are shown above the pins. Red arrows point from the text labels to the corresponding parts in the diagram.</p>

PKA	
Part Name	Image
<p>End Effector Assembly (Anspach Only)</p>	<p>Disassemble into 3 components (screws remain captured)</p>  <p>Captured Screws (2)</p> <p>ATTENTION!!</p> <p><u>DO NOT LOOSEN OR REMOVE</u></p>  <p>Alignment Plates</p> <p>Alignment Plate Screws (4 places)</p> <p>Loosening or removing the alignment plate screws will damage the End Effector</p>
<p>Base Array Assembly</p>	 <p>Remove and discard all VIZADISC (four places)</p>

PKA	
Part Name	Image
End Effector Array Assembly	 <p>Remove and discard all VIZADISC (four places)</p> <p>Disassemble Screw</p>
Sharp and Blunt Probes	 <p>Remove and discard all VIZADISC (three places)</p>
Motor and Attachment (Anspach Only)	 <p>Discard burr</p> <p>Disassemble</p>
MICS Handpiece Assembly	 <p>Remove and discard MICS Saw Blade</p> <p>Disconnect Saw Attachment</p>

PKA	
Part Name	Image
MICS Handpiece Assembly with Rotary Attachment	<p>Remove and discard Ball Burr</p>  <p>Disconnect Rotary Attachment and Long Guard</p>



No further MICS disassembly is required.



Do not remove the MICS Handpiece cable for cleaning or for sterilization. Ensure the MICS Cable Cap is in place for cleaning or sterilization, otherwise internal damage to cables could occur.



If the MICS handle components are removed for cleaning, ensure that the MICS handle is reassembled prior to sterilization, taking caution to not over-tighten the screw.

Reference the laminated sheets of each instrument kit for indication of instrument placement within the instrument trays.

G. INSTRUMENT CLEANING GUIDELINES

To properly clean, disinfect, and sterilize Mako (Stryker) instruments, manual and/or automated cleaning procedure(s) must be completed prior to autoclave sterilization as part of the disinfection process. Manual cleaning methods are to be followed if an ultrasonic cleaner is available, and central cleaning allows for use per internally validated methods. Manual cleaning is meant to augment the removal of difficult to access potential contaminant features of parts and assemblies. Follow the Automated Cleaning procedures, when using an automated washer system and per internal central sterile requirements determinations. For MAKO Surgical Corp. devices to be reused through the use of automated washer disinfectors, the washer-disinfectors in use at the customer central sterile department must meet the requirements for the ISO 15883 series regarding parameters for the medical devices of the A₀ specific load configuration, positioning, process chemicals, pressures or temperature limits.

Use the following general guidelines for all instruments:

- Wear eye protection and gloves when cleaning or handling contaminated instruments
- Do not immerse electronic equipment or cables in water or other liquids.
- Unless specified otherwise, do not disassemble instruments during cleaning or sterilization
- Neutral cleaning agents are recommended; alkaline agents, although allowable are not preferred. Alkaline agents may cause cosmetic damage and reduce the expected life of the product
- Use only the indicated solutions or solvents on equipment (reference Appendix A).



All health care workers should become familiar with the necessary Universal Precautions of preventing injuries caused by sharp instruments when handling these devices during and after surgical procedures, as well as during reprocessing.



Protect and handle delicate instruments so as to avoid damage during the cleaning process.



Disposables should not be cleaned or sterilized.



Cleaning, disinfecting, and sterilization should be performed by trained personnel only.



Do not allow blood and/or bodily fluids to dry on the instruments. The decontamination process should begin immediately after completion of the surgical procedure. Flash coagulation of blood components and component proteins may occur at temperatures above 20°C, therefore soak temperatures must be monitored accordingly.



Mako (Stryker) reusable instruments are not normally used in surgical procedures where they contact TSE infective tissue (Transmissible Spongiform Encephalopathies) as defined by the World Health Organization (WHO). Therefore, decontamination procedures with highly aggressive agents (i.e., sodium hydroxide (NaOH) or sodium hypochlorite (NaClO)) are not necessary and, for normal processing, are not recommended because material degradation may occur. The sterilization parameters recommended in this document are not intended and not suitable for inactivation of prions.



Pay particular attention to crevices, serrations, grooves, cannulas, screw holes, screw threads, and other difficult to clean areas until all soil has been removed. Any instruments with moving components should be set in motion during cleaning to ensure all surfaces are cleaned.



If damage is detected on any instrument, please contact MAKO Surgical Corp.'s parent company (Stryker).



Complete removal of soil from crevices depends on instrument construction, exposure time, pressure of delivered solution, and pH of the detergent solution may require prior brushing.

Cleaning and Disinfecting Procedures (Initial):

The reusable medical devices covered under these reprocessing procedures for cleaning, disinfection, and sterilization, require adherence to ISO 15883 with respect to use of washer disinfectors, as well as to general guidelines found in this section. The ISO 15883 series of documents introduced the concept of A_0 to allow comparison of lethality of disinfection processes, thereby ensuring washer/disinfector machine confidence and reliability (reference "Appendix A: Disinfection Strategy", Table 10 notes).



The quality of water used for diluting cleaning agents and/or disinfectants and for rinsing reusable instruments should be carefully considered according to AAMI TIR34, "Water for Reprocessing of Medical Devices." Hard water residues can result in staining of the device or prevent effective cleaning and sterilization. The use of saline solutions are not recommended due to possible corrosion.

Manual Cleaning



Do not remove the MICS Handpiece cable for cleaning or sterilization. Ensure MICS Cable Cap is in place for cleaning or sterilization, otherwise internal damage to cables could occur.



If the MICS handle components are removed for cleaning, ensure that the MICS handle is reassembled prior to sterilization, taking caution to not over-tighten the screw.

MICS Cleaning Instructions

1. **Disconnect** the cutting tool attachment and discard the cutting tool.
2. **Ensure** the cable cap has been put in place.
3. **Pre-rinse** with purified water less than 68°F (20°C) to remove all blood, tissue, and visible soil. If the product is extremely soiled, it may be necessary to pre-rinse for a longer period of time.
4. **Prepare** appropriate detergent and/or enzymatic cleaner according to manufacturer's recommended dilution using a medical grade water supply/source between 60°-100°F (15.5°-38°C).
5. **Thoroughly clean** each part with a soft bristled brush, pipe cleaner, or sterile syringe using the prepared detergent. Actuate handles, hinges, and retractable features. Pay particular attention to crevices, cannulas, threads, and other hard to clean areas.

6. **Rinse** parts in water for five (5) minutes while continuing to use a soft brush, syringe, or pipe cleaner. Actuate instruments while rinsing.
7. **Visually examine** all instruments for any noticeable soil.
8. **Repeat** cleaning, if necessary.
9. **Dry** MICS assembly using a clean soft cloth or pressurized air (max 40 psi).

Instrument Cleaning Instructions

1. **Disconnect** the tools, accessories, and disassemble instruments with multiple attachments/components (e.g., clamp assemblies), reference Table 6 .
2. **Pre-rinse** with purified water less than 68°F (20°C) to remove all blood, tissue, and visible soil. If the product is extremely soiled, it may be necessary to pre-rinse for a longer period of time.
3. **Prepare** an appropriate detergent and/or enzymatic cleaner according to manufacturer's recommended dilution using a medical grade water supply/source between 60°-100°F (15.5°-38°C).
4. **Fully immerse** the instruments in the prepared detergent and allow them to soak for a minimum of five (5) minutes.
5. **Thoroughly clean** each part with a soft bristled brush, pipe cleaner, or sterile syringe while soaking. Actuate handles, hinges, and retractable features. Pay particular attention to crevices, cannulas, threads, and other hard to clean areas.
6. **Rinse** parts in purified water for five (5) minutes while continuing to clean with a soft brush, syringe, or pipe cleaner. Actuate instruments while rinsing.
7. **Ultrasonically clean** all parts in an appropriate presoak-detergent (oz/gal) prepared as in Step 3 for twenty (20) minutes. Instruments must be fully immersed in solution during cleaning.
8. **Rinse** parts in purified water for five (5) minutes while continuing to clean with a soft brush, syringe, or pipe cleaner. Actuate instruments while rinsing.
9. **Visually examine** all instruments for any noticeable soil.
10. **Repeat** cleaning, if necessary.
11. **Dry** parts using a clean soft cloth or pressurized air (max 40 psi).

Automated Cleaning



Do not remove the MICS Handpiece cable for cleaning or sterilization. Ensure MICS Cable Cap is in place for cleaning or sterilization, otherwise internal damage to cables could occur.



If the MICS handle components are removed for cleaning, ensure that the MICS handle is reassembled prior to sterilization, taking caution to not over-tighten the screw.

MICS Cleaning Instructions

1. **Disconnect** the cutting tool attachment and discard the cutting tool.
2. **Ensure** the cable cap has been put in place.
3. **Pre-rinse** with purified water less than 68°F (20°C) to remove all blood, tissue, and visible soil. If the product is extremely soiled, it may be necessary to pre-rinse for a longer period of time.

4. **Prepare** an appropriate detergent and/or enzymatic cleaner according to manufacturer’s recommended dilution using a medical grade water supply/source between 60°-100°F (15.5°-38°C).
5. **Arrange** the instruments in the trays as indicated in the instrument laminate provided. The top level of each tray should be placed in the washer separately. All tray lids should be removed. All caddies should be placed in the washer separately with the caddy lid in the open position.
6. **Thoroughly clean** each part with a soft bristled brush, pipe cleaner, or sterile syringe using the prepared detergent. Actuate handles, hinges, and retractable features. Pay particular attention to crevices, cannulas, threads, and other hard to clean areas.

Table 7. Automated Cleaning

Phase	Dwell Time (minutes)	Temperature Range °F (°C)	Disinfectant Solution
Pre-wash (soak)	2	≤ 68°F (20°C)	USP Water for Irrigation or Equivalent
Disinfecting Wash	5	100°F (38°C) – 120°F (49°C)	User derived*
Neutralization Wash	10	User derived*	User derived*
Rinse	5	User derived*	User derived*
Thermal Disinfection	10	User derived*	User derived*
Drying	7	239.9°F (115.5°C)	N/A

*For user-derived parameters, reference Appendix A.

7. **Dry** instruments using a clean, lint-free, soft, dry cloth upon completion of the cycle if instruments are still wet.
8. **Visually examine** all instruments for any noticeable soil. Repeat the cleaning process, if necessary.

Instrument Cleaning Instructions

1. **Disconnect** the tools and accessories; disassemble instruments with multiple attachments/components (e.g., clamp assemblies).



All caddies must be removed from the instrument kit and prepared as an instrument/tray.

2. **Pre-soak** the instruments in an preferential enzymatic pre-soak category cleaner for five (5) minutes. Prepare the enzymatic cleaner according to manufacturer’s recommended dilution (oz/gal) using a purified water supply/source less than 60°F (15.5°C). Fully immerse the instruments, caddies, and trays separately in the bath during the pre-soak.



All instruments and caddies must be soaked in enzymatic cleaner separately then placed within the caddy.

Thoroughly clean each part with a soft bristled brush, pipe cleaner, or sterile syringe using the prepared detergent. Actuate handles, hinges, and retractable features. Pay particular attention to crevices, cannulas, threads, and other hard to clean areas.

3. **Rinse** instruments, trays, and caddies with purified water; brush with pipe cleaner or appropriate soft-bristle orifice fitting brush, all internal and external surfaces of instruments using soft brushes. Actuate all moving parts while brushing to remove any visible soil.
4. **Arrange** the instruments in the trays as indicated in the kit laminates provided. The top level of each kit should be placed in the washer separately. All tray lids should be removed. All caddies should be placed in the washer separately with the caddy lid in the open position. Where possible place the tray lids on the bottom shelf of the washing system.



Components must be placed in kits as pictured in applicable laminates to achieve proper sterilization.

5. **Select** washer cycles and ensure the cycle parameters are properly programmed.
6. Upon completion of the cycle, remove the trays, instruments, caddies, and lids from the washer.
7. **Dry** removed contents using a clean, lint-free soft cloth, or by using pressurized air, not exceeding forty (40) psi.
8. **Visually examine** all instruments for any noticeable soil. Repeat the cleaning process, if necessary.

Post Cleaning

Inspection

Before preparing for sterilization, all reusable instruments should be inspected. Generally unmagnified, visual inspection under good lighting is enough. All parts of the devices should be checked for visible soil and/or corrosion.

After cleaning, visually inspect devices under normal lighting for the removal of visible soil.

- Inspect soil traps such as mating surfaces, hinges, shafts of flexible drill bits, and recessed features (holes, cannulations).
- Inspect features where soil may be impacted into the device, such as drill flutes adjacent to the cutting tip.
- For difficult to view design features, apply 3% hydrogen peroxide. Bubbling is indicative of the presence of blood.

Functional Checks and Inspections

Visually inspect for damage, wear, and functional anomalies.

- Mating devices should be checked for proper assembly.
- Check edges of cutting features for distortion or damage. Edges should be sharp and continuous.
- Articulating surfaces should be smooth and free of cracks and deep nicks.
- Inspect metal surfaces for corrosion and major deformations.
- Instruments with moving parts should be operated to check correct operation.
- Rotating instruments, such as multiple-use drill bits, should be checked for straightness. This can be achieved by simply rolling the instrument on a flat surface.
- Flexible instruments should be checked for damage to the spiral element.

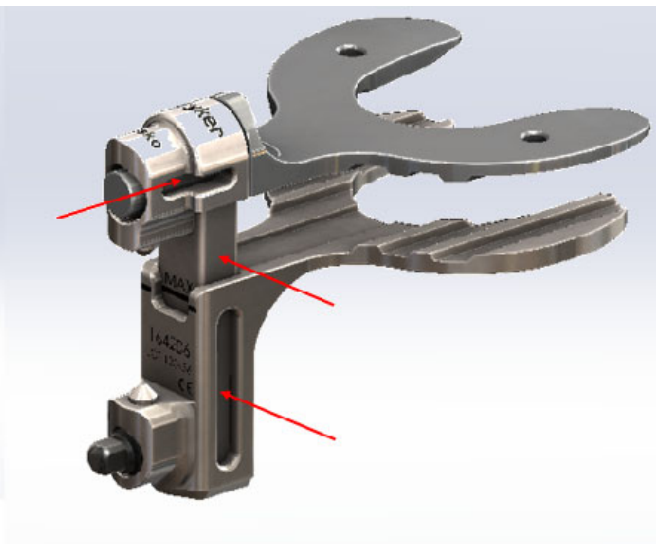
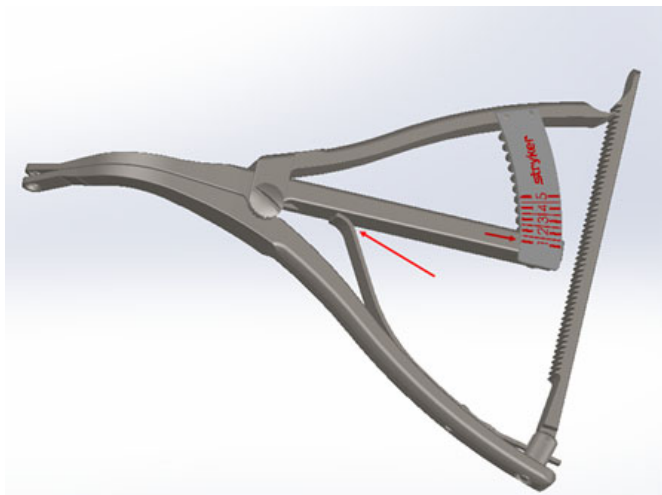
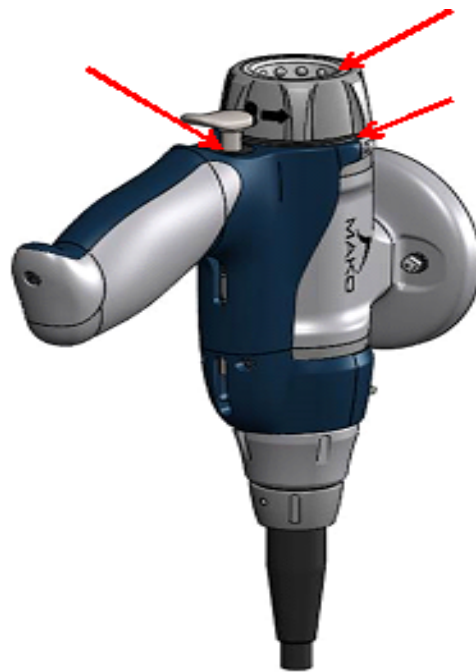
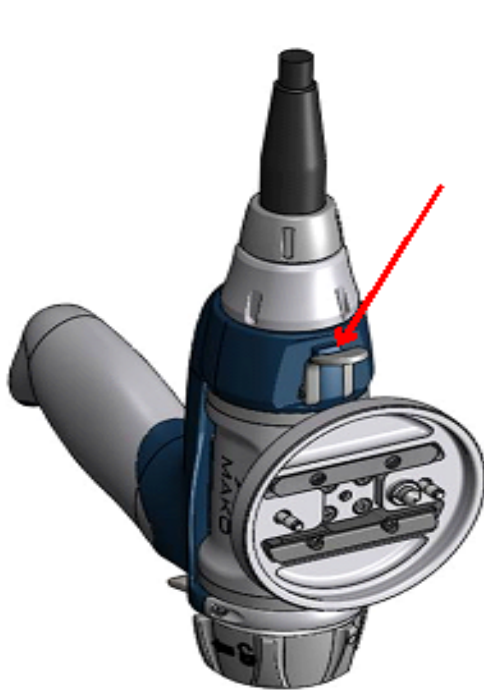
- For devices that may be impacted, check that the device is not damaged to the extent that it malfunctions or that burrs have been produced that could damage tissues or surgical gloves.



The useful life of these devices depends on many factors, including the method and duration of each use and handling between uses. Careful inspection and functional test of the instrument before use is the best method of determining the end of serviceable life.

Lubrication

Prior to sterilization, spray all joints and moving parts on the MICS Handpiece, Knee Tensioner, and Lamina Spreader with a moist heat compatible, medical grade lubricant. Refer below for critical areas that must be lubricated as indicated with red arrows in the figures.



H. STERILIZATION TRAYS



The presence of blood, tissue, soil, or soap residue may prevent the instrument(s) from being properly sterilized. Remove all debris and residue prior to sterilization. Failure to comply may prevent the tool(s) from being properly sterilized.

Sterilization trays do not by themselves provide a sterile barrier and must be used in conjunction with sterilization wrap and ISO 17665 validated rigid containers to maintain sterility.

Sterilization trays can be cleaned with water and a mild detergent.

Cleaned instruments should be assembled into the appropriate instrument tray or kit.



Do not remove the MICS Handpiece cable for cleaning or for sterilization. Ensure MICS Cable Cap is in place for cleaning or sterilization, otherwise internal damage to cables could occur.



If the MICS handle components are removed for cleaning, ensure that the MICS handle is reassembled prior to sterilization, taking caution to not over-tighten the screw.

I. STERILIZATION GUIDELINES



Ensure all instruments are removed from shipping packaging materials and thoroughly cleaned prior to sterilization. Place attached protective cap over electrical connector on Anspach electrical Motor prior to sterilization.



Longer cycles, such as those recommended for control or elimination of Transmissible Spongiform Encephalopathies may be utilized; however, instruments should be expected to have reduced functional life (applicable for OUS users only).



MAKO Surgical Corp. re-usable instruments are not recommended as candidates for customer immediate use ('flash') sterilization cycles.

Validation of Process and Responsibility

The instruments listed in Tables 1, 2, 3, and 4 may be sterilized using the sterilization parameters described in this manual.



For information regarding the sterilization of non-Mako (Stryker) instruments, reference the appropriate instructions for use.

Mako (Stryker) instruments not included in an instrument set should be cleaned and sterilized separately.

The set parameters indicated were validated with one instrument set in the sterilizer. It is the responsibility of the healthcare facility to qualify their sterilizers' maximum load capacity and determine what effect the loading pattern of the sterilizer has on the sterilization of devices.



The healthcare facility is ultimately responsible for ensuring that any packaging method or material is suitable for use in the sterilization processing and sterility maintenance. Testing must be conducted in the healthcare facility to validate that conditions essential to sterilization can be achieved.



Reference the appropriate steam sterilizer instructions for use for complete information on the operation and use of these types of sterilizers.



MAKO Surgical Corp. has validated the following sterilization cycles based on ISO guidelines and recommendations.



Do not sterilize the rubber protection caps, packaging materials, package insert, and labels. Prior to sterilization, remove and discard the rubber protection caps and packaging material from the instruments.



Implants and instruments which are supplied **STERILE** must not be re-sterilized as this process has not been validated.

Table 8 describes the sterilization techniques in terms of method, cycle, temperature, exposure time, and dry time for all instrument and trays for use within the US.

Table 8. Sterilization Techniques (US)

Method	Cycle	Minimum Temperature	Minimum Exposure Time (minutes)	Minimum Drying Time (minutes)
Moist heat sterilization per ISO 17665 ANSI/AAMI ST79	Pre-Vacuum (Dynamic air removal)	132°C - 134°C (270°F-273°F)	4	See Appendix B



The MICS Handpiece will not power on if it is too hot. Allow the MICS Handpiece time to cool such that the staff can easily handle the instrument.

Table 9 describes the sterilization techniques in terms of method, cycle, temperature, exposure time, and dry time for all instrument and trays for use outside the US.

Table 9. Sterilization Techniques (OUS)

Method	Cycle	Minimum Temperature	Minimum Exposure Time (minutes)	Minimum Drying Time (minutes)
Moist heat sterilization per ISO 17665 ANSI/AAMI ST79	Pre-Vacuum (Dynamic air removal)	134°C - 137°C (273°F-278.6°F)	3	See Appendix B

J. REUSABILITY

Surgical instruments and trays are susceptible to damage from prolonged use, misuse, or inappropriate handling. Care must be taken to avoid compromising their performance. To minimize damage:

- Inspect trays and instruments for damage when received and after each use.
- Improperly cleaned instruments should be re-cleaned.
- Trays requiring repair should be returned for servicing.

K. CONDITIONS FOR STORAGE



Instruments should be stored in a dry, clutter-free area and positioned so that trays and kits are protected from being bumped or damaged.

Storage and Shelf Life

Instrument trays and kits that have been wrapped and sterilized or placed in a rigid container and sterilized, should be stored in a manner to avoid extremes in temperature and moisture. Care must be taken in handling wrapped trays and kits to prevent damage to the sterile wrap. It is the responsibility of the healthcare facility to establish a shelf life for wrapped instrument trays and kits, based upon the type of sterile wrap used and the recommendations of the sterile wrap manufacturer or rigid tray manufacturer.



Shelf life and handling may affect sterility over time.

Appendix A: Disinfection Strategy

Users may derive a custom automated cleaning cycle based on the data and standards listed in Appendix A and B provided they perform an internal validation.

Table 10. Customer Disinfection Strategy

Chosen Disinfection Strategy	WD Target A_0 Level (Sec)	WD Temperature Setpoint °F (°C)	Holding Time (minutes)	Rinse Water Temperature °F (°C)	Suggested Disinfecting Solution	Target Solution pH
1	600	70	100	≥ 149°F (65°C)	Enzymatic	The pH of the chosen disinfecting solution will increase activity in ionized form for certain disinfectants, or increase activity in non-ionized form for others.
2	600	80	10	≥ 149°F (65°C)	Enzymatic	
3	600	90	1	≥ 149°F (65°C)	Non-Enzymatic	
4	1200	93	1	≥ 149°F (65°C)	Non-Enzymatic	

Notes:

ISO 15883 defines the A_0 of a moist-heat disinfection process as the equivalent time in seconds at 80°C (176°F) to produce a given disinfection effect on microorganisms possessing a z value of 10°C (50°F). Temperatures below 65°C (149°F) should not be used because the killing kinetics for thermophilic organisms can change dramatically; below 55°C (131°F), several organisms remain viable.

The A_0 number provides a method of correlating the killing ability of moist heat as a time versus temperature equation for an organism having a specified z value.

The higher the temperature, the shorter the time needed to kill specific types of microorganisms. Equivalent killing efficacy can be achieved at different temperatures, provided the time of exposure is regulated so that the same net effect is produced. For example, an A_0 of 600 (the general requirement for a washer–disinfector, as specified in ISO 15883-1) can be achieved by holding the temperature at 80°C (176°F) for 10 minutes or at 90°C (194°F) for 1 minute or at 70°C (158°F) for 100 minutes.

To produce desired A_0 values, thermal disinfection exposure temperatures and hold times should be identified and followed per the customer disinfection strategy in Appendix A above. Performance characteristics depend on the type of washer/disinfector unit(s) used, the unit age or condition, and the selected disinfecting solutions.

Table 11. Global Cleaning Parameters/Standards

International *WD parameters are per the following standards:		
Australia / New Zealand	ISO TS 15883-4	Per ISO 15883-5 Harmonized Revision
Europe and United Kingdom	ISO TS 15883-5	
Canada	ISO 17664:2004 or equivalent CAN/CSA 17664-2011	
United States	ISO AAMI TIR30/BS EN ISO 15883/ANSI AAMI ISO ST79	
EEMEA	No specific requirements exist. Follow parameters in IFU.	
APAC	AS/NZS 4187-2014	

* WD refers to the washing disinfection automated cleaning equipment in use at the end use facility be it hospital, clinic, research center or other established health care provider location. For all A_0 values listed, the process Z value is assumed to be 10°C.

Table 12. Global Sterilization Parameters/Standards

International sterilization parameters are per the following standards:		
Australia / New Zealand	AS/NZS 4187	Per BS EN ISO 17664/17665 Harmonized Revision
Europe and United Kingdom	EN ISO 17664	
Canada	CAN/CSA-ISO 17664:2004; CSA Z314-18; AAMI ST 79	
United States	EN ISO 17664/EN ISO 17665/ANSI AAMI ISO ST79	
EEMEA	ISO 17665-1 2007	
APAC	AS/NZS 4187-2014	

Appendix B: Extended Dry Time Table

Table 13. Wrapped for Steam Sterilization Only

Description	Minimum Dry Time	Disinfection Strategy From Appendix A
Mako THA Array Instrument Kit	30	2
Mako Hip Instrument Kit	45	2
Mako Knee Array/Balancing Kit	30	3
Mako Partial Knee Array Instrument Kit	30	1
Mako Power System and Attachment Kit	60	3
MAKOplasty Hip Acetabular Reamer Basket Kit	30	2
Mako Power Tray	30	2
MCK Patellofemoral Instrument Kit	30	1
RESTORIS MCK Manual Instrument Kit	30	1
RESTORIS MCK Unicondylar Instrument Kit*	45	1
Stryker Leg Positioner Instrument Kit	45	3


**If the Onlay Insert Extractor is present, the double wrapped minimum drying time (minutes) must be extended to 45 minutes.*

A surgeon must always rely on his or her own professional clinical judgment when deciding whether to use a particular product when treating a particular patient. Stryker does not dispense medical advice and recommends that surgeons be trained in the use of any particular product before using it in surgery.

The information presented is intended to demonstrate the breadth of Stryker product offerings. A surgeon must always refer to the package insert, product label and/or instructions for use before using any Stryker product. The products depicted are CE marked according to the Medical Device Directive 2017/745 or the Medical Device Directive 93/42/EEC. Products may not be available in all markets because product availability is subject to the regulatory and/or medical practices in individual markets. Please contact your Stryker representative if you have questions about the availability of Stryker products in your area.

Stryker Corporation or its divisions or other corporate affiliated entities own, use or have applied for the following trademarks or service marks: Mako, MAKO Surgical Corp., Stryker, and VIZADISC. All other trademarks are trademarks of their respective owners or holders.

PN 700001056525 Rev AB 02/21
Copyright © 2021 Stryker
Printed in USA

 MAKO Surgical Corp.
3365 Enterprise Ave.
Weston, FL 33331 USA

R_x ONLY
CE 2797