

Ortho Grip Knee Pointer

REF 6003-012-000

Pointer, Rotational Curved

REF 6007-012-000

Pointer, Straight

REF 6007-011-000

stryker

Instructions for Use

Rx Only

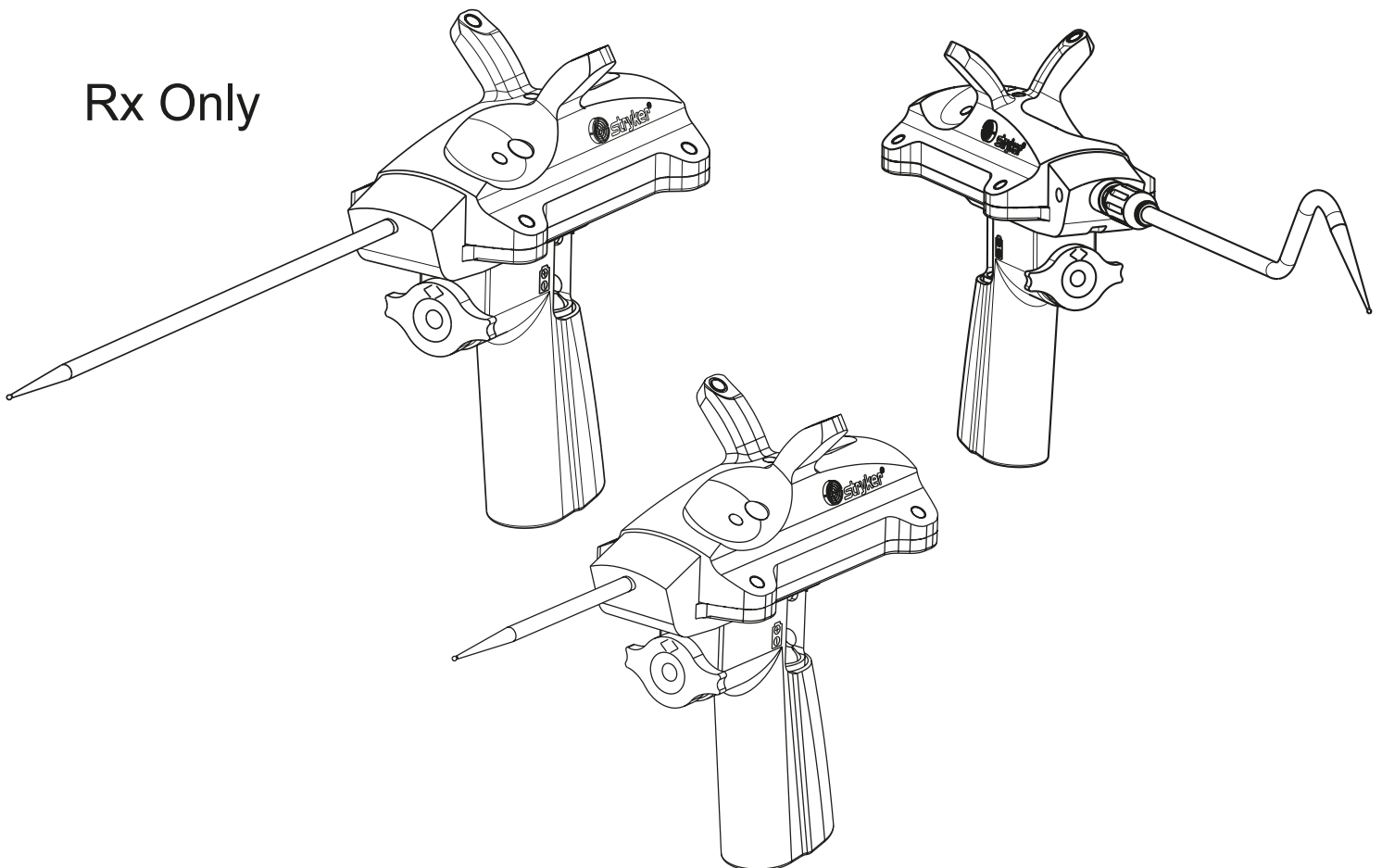

Intended Use

Pointer, Rotational Curved, Pointer Straight, and Ortho Grip Knee Pointer are intended for use with the Stryker navigation system - Hip Modules. The Ortho Grip Knee Pointer and the Pointer Straight are also intended for use with the Knee Modules.

All these pointers are used to indicate the spatial relationship between the patient and the pointer. The instrument's position, as it relates to the patient anatomy, is displayed on the monitor. Moreover, the pointers may be used to control the navigation system software and, in addition, to validate an instrument with mounted Instrument Tracker REF 6007-008-000 or Patient Tracker, Blue, REF 6007-010-000.

Contraindications

None known.

User Group

Healthcare professionals (surgeon/resident, nurse/professional caregiver) educated in computer-assisted surgery and thoroughly familiar with the instructions for use and with the operation of this product. To request an additional in-service instruction, contact Stryker.

NOTE:

The following conventions are used in this document:

The signal word **WARNING** highlights a safety-related issue. Comply with this information to prevent patient and medical staff injury.

The signal word **CAUTION** highlights a product reliability issue. Comply with this information to prevent product damage.

User/Patient Safety



WARNING

- Read and understand this information, file it in your maintenance records. Familiarization with the Stryker navigation system prior to use is important. *Refer to the instructions for use of the navigation system.*
- The instrument should only be used in accordance with the instructions for use contained in this manual.
- Prior to each use, inspect the instrument. Breakage of glass, loose components, fogged or wet glass on the inside of the LEDs may lead to compromised functionality of the instrument. Do not use if any of these conditions exist. Contact your Stryker Navigation sales representative in such case.
- Prior to each use, the instruments should be operated with the Stryker navigation system to ensure they are functioning properly.
- Clean and sterilize instruments before first and every use. *Refer to the Guide for Cleaning, Disinfection and Steam-Based Sterilization (TD6000005750).*
- This equipment is not suitable for use in the presence of flammable anesthetic mixtures with air oxygen or nitrous oxide.
- During surgery, if fluids such as saline solutions enter the battery holder, the electronics can fail and communication with the system will cease.
- Prior to and during the surgical procedure, regularly verify the position of the pointer by touching a known anatomical landmark.
- Performing procedures with instruments other than those specified in these instructions or outside of their intended use will compromise the navigation accuracy.
- Do not use the pointer for other purposes than for navigation. The point-

- er's tip may be damaged and navigation accuracy may fail.
- Use only Stryker approved components and accessories, unless otherwise specified. Other accessories may result in increased electromagnetic emissions or decreased electromagnetic immunity of the system. Do not modify any component or accessory. Failure to comply may result in patient and/or health care staff injury.
 - In case of the presence of EM disturbance, degradation of the performance of this equipment could result.
 - Use of this equipment adjacent to or stacked with other equipment should be avoided because it could result in improper operation. If such use is necessary, this equipment and the other equipment should be observed to verify that they are operating normally.
 - Portable RF communication equipment (including peripherals such as antenna cables and external antennas) should be used not closer than 30 cm (or 12 inches) to the pointer. Otherwise, degradation of the performance of this equipment could result.
 - Do not service the instruments. They contain no parts the user can service. If service is required, contact your Stryker Navigation sales representative.
 - The healthcare provider performing any procedure is responsible for determining the appropriateness of the instrument and the specific technique for each patient. Stryker, as a manufacturer, does not recommend a specific surgical procedure.
 - Following patient registration, any change in the position of the patient tracking system relative to the patient compromises navigation accuracy. In such case, the patient must be reregistered.
 - The tip of the instrument must be precisely placed in the center of the validation disk to ensure an accurate validation.
- Use Instrument Battery REF 6000-006-000 only. Load a new battery before first and every use as instructed in this manual.
 - During surgery, always keep a sterile replacement Instrument Battery available.
 - Remove the Instrument Battery as instructed in this manual before cleaning and sterilizing the navigated instrument.
 - Do not sterilize Instrument Batteries; they are supplied sterile and must not be resterilized.
 - Excessive infrared radiation from external sources can influence localization of the instruments by the navigation system. *Refer to the Navigation System Camera Instructions for Use.*
 - During surgery, keep the LEDs clean and out of contact with liquids at all times. Failure to comply may compromise navigation accuracy.
 - Navigated instruments contain multiple infrared LEDs, a transmit LED and a receiver. All of the LEDs must be in view of the camera for the navigation system to function properly.
- CAUTION:**
- Do not apply any physical impact to the pointer, especially with a mallet or similar tool. Any impact will cause product damage or operational failure due to battery movement.
 - To avoid malfunction, do not scratch or damage the LEDs in any way.
- NOTE:**
- The user and/or patient should report any serious product-related incident to both the manufacturer and the national competent authority where the user and/or patient is established.

Function and Features

Refer to Figure 1.

SELECT Button (A)

- Press to initialize the pointer.
- After initialization, press to select software interface functions displayed on the navigation system monitor.
- After initialization, turn clockwise to move forward through the software or highlight an item below, in a list of menu selectable items.
- After initialization, turn counterclockwise to move backward through the software or highlight an item above, in a list of menu selectable items.

Validation Disks (E)

- Used as reference points, touch the disk cross hairs with the instrument tip to validate the instrument.

Green Status Light (D)

- During instrument initialization, the light flashes rapidly.
- During normal operation, the light flashes every few seconds.
- If instrument power is low, the light illuminates continuously. Replace the battery.

Battery Holder (G)

Infrared LEDs (Light Emitting Diodes) (F), Transmit LED (B) and Receiver (C)

- Emit and receive infrared light signals that are used to provide a wireless communication link to the Navigation System camera.

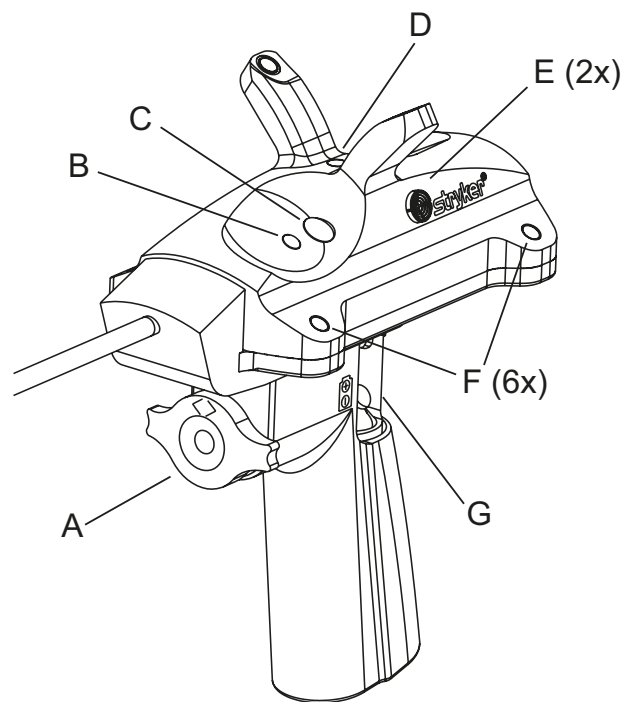

Figure 1: Functional Parts

Instructions



WARNING

Use only a new, sterile Instrument Battery REF 6000-006-000.

1 Instrument Battery

- 1.1 Remove the battery from the sterile package.
- 1.2 Press the negative end of the battery into the battery holder and against the spring.

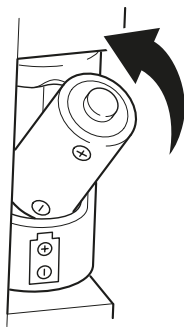

- 1.3 Observe the green status light illuminate for three seconds to indicate that the device is functioning properly.
- 1.4 To remove the battery, gently press down on the positive end of the battery and pull it away from the battery holder.

NOTE:

After changing the battery during operation, press the SELECT button until the pointer is initialized again.

2 Initialize Pointer

NOTE:

Align the Pointer's LEDs, transmit LED and receiver with the camera.

- 2.1 Wait for the navigation system to prompt you before initializing the instrument.
- 2.2 Once in the System Setup Mode, and prompted by the software interface, momentarily press the SELECT button until the device is initialized.

- 2.3 Observe the green status light flash rapidly during initialization.
- 2.4 Once initialized, observe the green status light flash slowly and a system message appear on the monitor indicating instrument recognition.

3 Validate Pointer

- 3.1 Initialize the tracker.
- 3.2 Align the pointer's LEDs, transmit LED and receiver with the camera.
- 3.3 Touch and center the pointer's end point (tip) in the cross hairs of the validation disk located on the tracker and press the instrument's SELECT button.
- 3.4 If the validation fails, re-initialize the pointer.
- 3.5 If re-initialization fails, replace the pointer.

Instrument Validation for hip applications only:

4 Validate Instrument

- 4.1 Mount the Instrument Tracker REF 6007-008-000 (or, for iNfinitus Hip Resurfacing only, the Patient Tracker, Blue, REF 6007-010-000) onto the appropriate mounting point on the instrument. *Refer to the instructions for use supplied with the tracker.*
- 4.2 Hold the pointer and the instrument in such a way that the infrared LEDs, transmit LED and receiver are aligned towards the camera.
- 4.3 Touch the validation point marked on the instrument with the pointer's tip and press the pointer's SELECT button. The system will validate the instrument's data.
- 4.4 If the validation fails, touch the instrument's validation point slightly changing the orientation of the pointer's tip. If the validation fails again, the instrument may be damaged and must no longer be used. Replace it with another one.

Rotational Curved Pointer only:

5 Rotate Pointer Tip

- 5.1 In order to rotate the Rotational Curved Pointer's tip, use the checkered handle (**H**) at the beginning of the tip (see figure 2).
- 5.2 Ensure the tip is engaged and cannot be rotated easily.
- 5.3 The curve of the pointer enables the user to reach areas difficult to access. Please note, that the pointer's axis used by the software corresponds with the virtual straight (**K**) from the beginning of the tip to its very end (see figure 2).

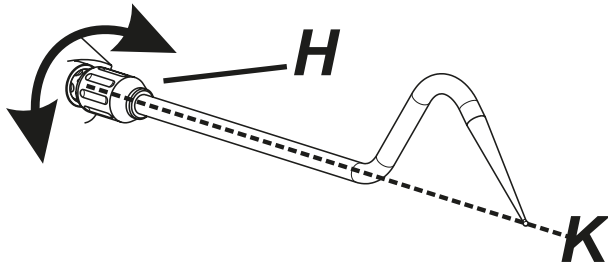

Figure 2: Rotational Curved Pointer Tip

Cleaning and Inspection Instructions

Cleaning Group IV.

Refer to the Guide for Cleaning, Disinfection and Steam-Based Sterilization (TD6000005750) for cleaning safety and caution notes, cleaning equipment and detailed cleaning and inspection instructions intended for instruments with electronics.

Sterilization Instructions

Refer to the Guide for Cleaning, Disinfection and Steam-Based Sterilization (TD6000005750) for detailed sterilization instructions and caution notes.

Disposal

Products and batteries that have been in contact with material of human origin may be infectious. Safely remove the batteries from the device with the necessary precautionary measures. Contact your local distributor for disposal information.

To comply with European Directive 2012/19/EU on Waste Electrical and Electronic Equipment (WEEE), products and batteries must be collected separately for recycling. Do not dispose of as unsorted municipal waste. Ensure infected products are decontaminated prior to recycling.

For Use With



WARNING

Use only Stryker-approved devices, unless otherwise specified.

For information related to compatible software applications, refer to the user manual of the software application.

Technical Specifications*

Ortho Grip Knee Pointer

Size: 161.2 mm [6.28 in] height
67.0 mm [2.61 in] width
235 mm [9.25 in] length
Weight¹: 365 g [12.87 oz.] weight

Pointer, Rotational Curved

Size: 161.2 mm [6.28 in] height
67.0 mm [2.61 in] width
350 mm [13.78 in] length
Weight¹: 430 g [15.17 oz.] weight

Pointer, Straight

Size: 161.2 mm [6.28 in] height
67.0 mm [2.61 in] width
340 mm [13.38 in] length
Weight¹: 395 g [12.93 oz.] weight

Material: Aluminum (housing); stainless steel (tip); PPSU (battery housing)

Power supply: 3 V \equiv , internally powered (lithium battery CR 2)

Enclosure protection: IPX0 Ordinary Equipment

Approvals:

CSA International cCSAus
EN / IEC 60601-1
EN / IEC 60601-1-2
ANSI/AAMI ES60601-1
CAN/CSA-C22.2 No. 60601-1

Operation

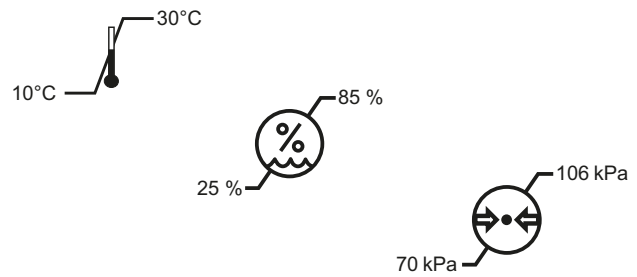

Storage and Transportation

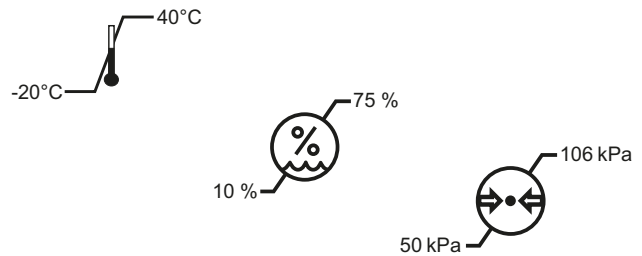

* Specifications listed are approximate and may vary slightly from unit to unit.

¹ Values without Instrument Battery.

Troubleshooting Guidelines

Pointer fails to power up when battery is installed:

- Battery is installed improperly. Reinstall battery.
- Battery power is low. Replace battery.
- Pointer is damaged. Return pointer for service.

Pointer cannot be initialized:

- Battery is installed improperly. Reinstall battery.
- Battery power is low. Replace battery.
- Transmit LED or receiver are damaged. Return pointer for service.
- SELECT button is stiff or defective. Return pointer for service.

Navigated instrument cannot be validated by Pointer:

- Battery power is low. Replace battery.
- Infrared LED, transmit LED or receiver are defective. Return navigated instrument for service.
- Pointer's tip is damaged or bent. Return pointer for service.
- Navigated instrument is damaged. Replace instrument with another one. If no navigated instrument is available, conventional surgery can always be performed.
- Incorrect navigated instrument chosen. Compare the reference number shown on the summary screen with the number on the chosen instrument.

Range of movement limited:

- One or more of the LEDs are dirty or do not function properly. Clean surface of the LEDs. If cleaning does not improve the function, return the instrument for service.

Green status light illuminates continuously:

- Battery power is low. Replace battery.

Communication with the system fails after navigation software is restarted:

- Remove and insert battery. Reinitialize instrument.



Pointer is not visible.

- Line of sight between pointer and camera is interrupted. Remove obstruction and system will resume communication.









Definition of Symbols

The following table defines the symbols used in this document, on the product and on the product label.

EN ISO 7010 Graphical symbols – Safety colors and safety signs – Registered safety signs



Symbol/ Number	Name: Definition
 W001	General warning sign: To signify a general warning.
 M002	Refer to instruction manual/booklet: To signify that the instruction manual/booklet must be read.

EN ISO 15223-1 Medical devices – Symbols to be used with medical device labels, labelling and information to be supplied – Part 1: General requirements







Symbol/ Number	Name: Definition
 5.1.1	Manufacturer: Indicates the medical device manufacturer as defined in the European Union harmonization legislation.
 5.1.3	Date of manufacture: Indicates the date when the medical device was manufactured.
 5.1.5	Batch code: Indicates the manufacturer's batch code so that the batch or lot can be identified.
 5.1.6	Catalog number: Indicates the manufacturer's catalog number so that the medical device can be identified.
 5.1.7	Serial number: Indicates the manufacturer's serial number so that a specific medical device can be identified.
 5.2.7	Non-sterile: Indicates a medical device that has not been subjected to a sterilization process.
 5.3.7	Temperature limit: Indicates the temperature limits to which the medical device can be safely exposed.
 5.3.8	Humidity limitation: Indicates the range of humidity to which the medical device can be safely exposed.

Symbol/ Number	Name: Definition
 5.3.9	Atmospheric pressure limitation: Indicates the range of atmospheric pressure to which the medical device can be safely exposed.

IEC 60417 Graphical symbols for use on equipment

Symbol/ Number	Name: Definition
 5301	Direct current: To indicate on the rating plate that the equipment is suitable for direct current only; to identify relevant terminals.
 5333	Type BF applied part: To identify a type BF applied part complying with IEC 60601-1.

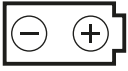
Product-specific symbols

Symbol	Name: Definition
	Quantity: Indicates the number of products in the packaging.
GTIN	Global Trade Item Number.
	Select
	Forward UP
	Backward DOWN
	Battery + positive terminal, - negative terminal
	Medical device: Indicates a medical device according to European Union harmonization legislation.



81 FR 38911 FDA Final rule for the use of symbols in labeling

Symbol	Name: Definition
Rx Only	Caution: Federal law (USA) restricts this device to sale by or on the order of a physician.

Directive 2012/19/EU on waste electrical and electronic equipment (WEEE)

Symbol	Definition
	Indicates that the product must be collected separately and must not be disposed of as unsorted municipal waste.

Regulatory marks and logos

Symbol	Definition
	Indicates that a device is in conformity with the applicable requirements set out in applicable European Union harmonization legislation providing for its affixing.
	CSA certified for Canada and USA.



Translated Equivalent: TD6007012713

U.S. Patents: www.stryker.com/patents

Stryker Corporation or its divisions or other affiliated entities own, use or have applied for the following trademarks or service marks: Leibinger, Stryker. All other trademarks are trademarks of their respective owners or holders.

Copyright © 2019 Stryker



Stryker Leibinger GmbH & Co. KG
Bötzingen Straße 41
79111 Freiburg (Germany)
t: +49 761 4512 0 (Germany)
t: +1 269 323 7700 (USA)

REF 6003-012-000 (C) (E) 0197

REF 6007-011-000 (C) (E) 0197

REF 6007-012-000 (C) (E)