

Instrument Tracker

REF 6007-008-000

stryker

Instructions for Use

CE

Rx Only

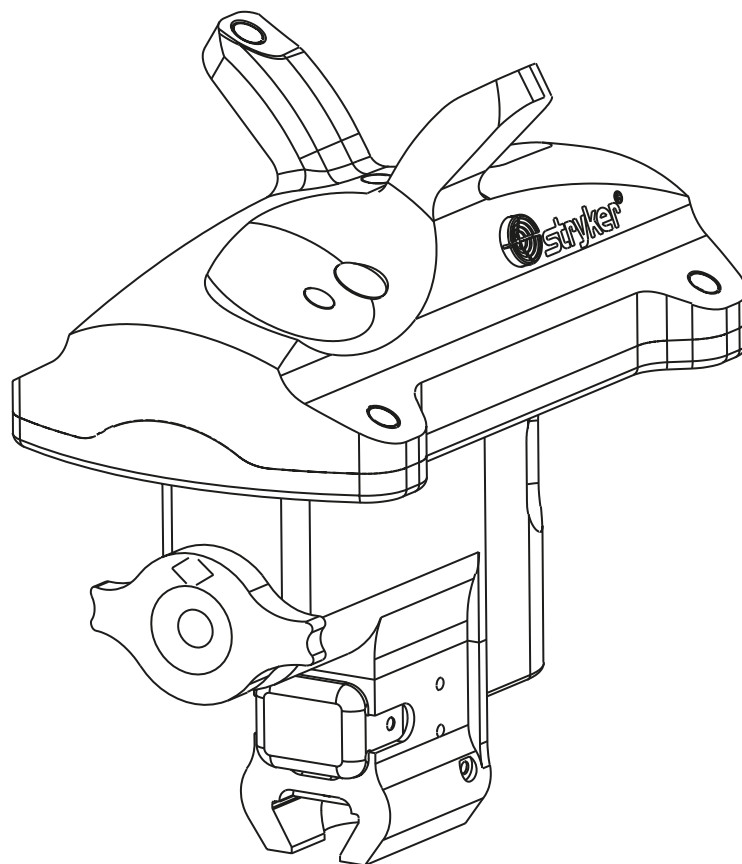

①

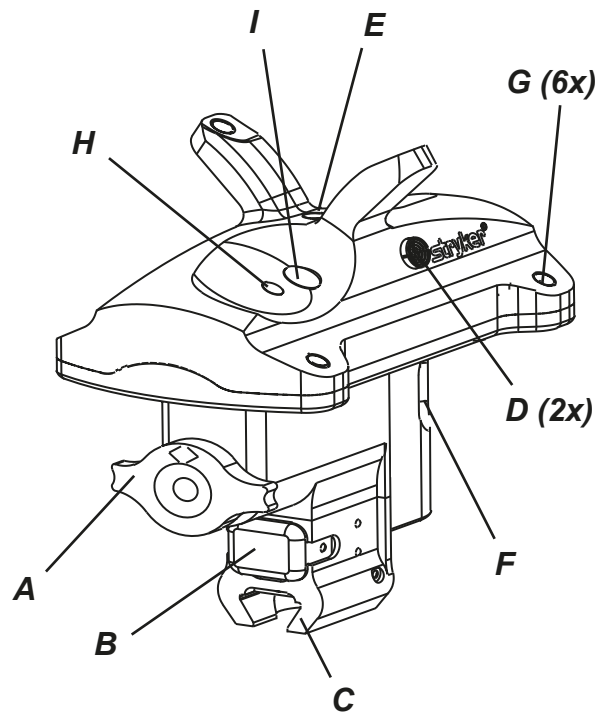

②

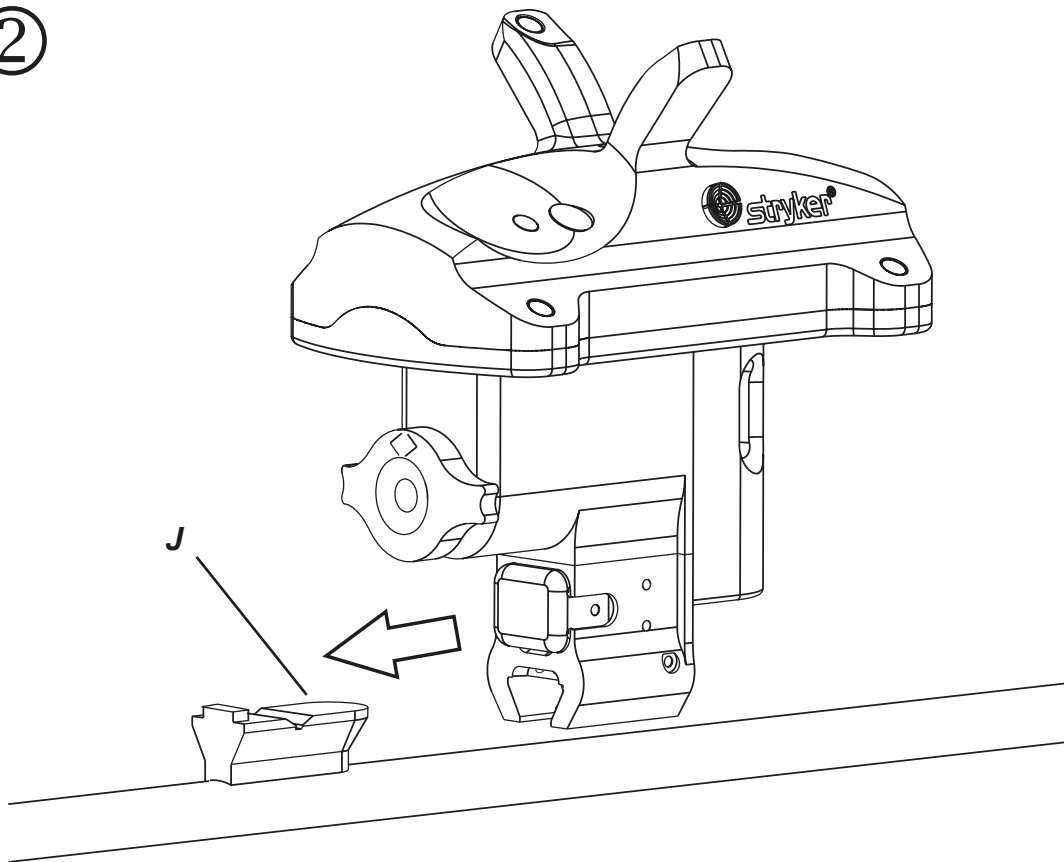

Intended Use

The Instrument Tracker is intended for use with the Stryker navigation system - Hip Modules.

The Instrument Tracker is used for instrument tracking and is intended to be mounted to multiple surgical instruments having been modified for navigation. Moreover, the Instrument Tracker may be used to control the navigation system software and, in addition, to validate pointers.

Contraindications

None known.

User Group

Healthcare professionals (surgeon/resident, nurse/professional caregiver) educated in computer-assisted surgery and thoroughly familiar with the instructions for use and with the operation of this product. To request an additional in-service instruction, contact Stryker.

NOTE:

The following conventions are used in this document:

The signal word **WARNING** highlights a safety-related issue. Comply with this information to prevent patient and medical staff injury.

The signal word **CAUTION** highlights a product reliability issue. Comply with this information to prevent product damage.

User/Patient Safety

WARNING

- Read and understand this information, file it in your maintenance records. Familiarization with the Stryker navigation system prior to its use is important. *Refer to the instructions for use of the navigation system.*
- The instrument should only be used in accordance with the instructions for use contained in this manual.
- Prior to each use, inspect the instrument. Breakage of glass, loose components, fogged or wet glass on the inside of the LEDs may lead to compromised functionality of the instrument. Do not use if any of these conditions exist. Contact your Stryker Navigation sales representative in such case.
- Prior to each use, the instruments should be operated with the Stryker navigation system to ensure they are functioning properly.
- The healthcare provider performing any procedure is responsible for determining the appropriateness of the instrument and the specific technique for each patient. Stryker, as a manufacturer, does not recommend a specific surgical procedure.
- Performing procedures with instruments other than those specified in these instructions or outside of their intended use will compromise the navigation accuracy.
- Use only Stryker approved components and accessories, unless otherwise specified. Other accessories may result in increased electromagnetic emissions or decreased electromagnetic immunity of the system. Do not modify any component or accessory. Failure to comply may result in patient and/or health care staff injury.
- In case of the presence of EM disturbance, degradation of the performance of this equipment could result.

- Use of this equipment adjacent to or stacked with other equipment should be avoided because it could result in improper operation. If such use is necessary, this equipment and the other equipment should be observed to verify that they are operating normally.
- Portable RF communication equipment (including peripherals such as antenna cables and external antennas) should be used not closer than 30 cm (or 12 inches) to the Instrument Tracker. Otherwise, degradation of the performance of this equipment could result.
- Use Instrument Battery REF 6000-006-000 only. Load a new battery before first and every use as instructed in this manual.
- During surgery, always keep a sterile replacement Instrument Battery available.
- Remove the Instrument Battery as instructed in this manual before cleaning or sterilizing the navigated instrument.
- Do not sterilize Instrument Batteries; they are supplied sterile and must not be resterilized.
- Clean and sterilize the instrument before first and every use. *Refer to the Guide for Cleaning, Disinfection and Steam-Based Sterilization (TD6000005750).*
- This equipment is not suitable for use in the presence of flammable anesthetic mixtures with air, oxygen or nitrous oxide.
- During surgery, if fluids such as saline solutions enter the battery holder, the electronics can fail and communication with the system will cease.
- During surgery, keep the LEDs clean and out of contact with liquids at all times. Failure to comply may compromise navigation accuracy.
- Excessive infrared radiation from external sources can influence localization of the instrument by the navigation system. *Refer to the Navigation System Camera Instructions for Use.*
- Do not service the instrument. It does not contain any parts the user can service. If

service is required, contact your Stryker Navigation sales representative.

- Prior to proceeding, verify that the Instrument Tracker is firmly attached to the instrument as instructed. If the tracker moves relative to the instrument, navigation is inaccurate.
- Navigated instruments contain multiple infrared LEDs, a transmit LED and a receiver. All of the LEDs must be in view of the camera for the navigation system to function properly.

CAUTION

- Do not apply any physical impact to the navigated instrument, such as with a mallet or a similar tool. Any impact will cause product damage or operational failure due to battery movement.
- To avoid malfunction, do not scratch or damage the LEDs in any way.
- For increasing the longevity of the Instrument Tracker, we recommend that you remove the Instrument Tracker from the instrument if you have to apply heavy impacts on the instrument, for example when fixing a cup.

NOTE:

The user and/or patient should report any serious product-related incident to both the manufacturer and the national competent authority where the user and/or patient is established.

Function and Features

Refer to figure ① on page 2.

SELECT Button (A)

- Press to initialize the instrument.
- After initialization, press to select software interface functions displayed on the navigation system monitor.
- After initialization, turn clockwise to move forward through the software or highlight an item below, in a list of menu selectable items.
- After initialization, turn counterclockwise to move backward through the software or highlight an item above, in a list of menu selectable items.

Release Button (B) and Tracker Interface (C)

- These features allow the tracker to be secured to and detached from the navigated instrument.

Validation Disks (D)

- Used as reference points, touch the disk cross-hairs with the instrument tip to validate the instrument.

Green Status Light (E)

- During instrument initialization, the light flashes rapidly.
- During normal operation, the light flashes every few seconds.
- The light illuminates continuously, if instrument power is low.

Battery Holder with Sleeve (F)

Infrared LEDs (Light Emitting Diodes) (G), Transmit LED (H) and Receiver (I)

- Emit and receive infrared light signals that are used to provide a wireless communication link to the navigation system's camera.

Instructions

1 Instrument Battery

WARNING

Only use a new, sterile Instrument Battery REF 6000-006-000.

- 1.1 Remove the battery from the sterile package.
- 1.2 Open the battery housing by sliding down the battery sleeve.
- 1.3 Press the negative end of the battery into the battery holder and against the spring.

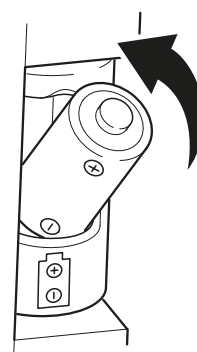

- 1.4 Close the battery holder by sliding the sleeve back in position.
- 1.5 Observe the green status light illuminate for three seconds to indicate that the device is functioning properly.
- 1.6 To remove the battery, gently press down on the positive end of the battery and pull it away from the battery holder.

NOTE:

After changing the battery during operation, press the SELECT button until the instrument is initialized again.

2 Initialize Instrument

NOTE:

Ensure the line of sight between the instrument and the camera is not blocked, and that the instrument's infrared LEDs, transmit LED and receiver directly face the camera.

- 2.1 Wait for the navigation system to prompt for the initialization before initializing the instrument.
- 2.2 Once in the system setup mode, and prompted by the software interface, press the SELECT button until the device is initialized.
- 2.3 Observe the green status light flash rapidly during initialization.
- 2.4 Once initialized, observe the green status light flash slowly and a system message appear on the monitor indicating instrument recognition.

3 Mount Instrument Tracker



Ensure the tracker snaps into position. The tracker must be rigidly fixated on the instrument during surgery. Failure to comply may lead to navigation inaccuracy.

- 3.1 Align tracker and instrument as shown in figure ②.
- 3.2 Slide quickly the Instrument Tracker over the instrument interface (**J**) of the instrument intended for navigation until the tracker snaps into position. The right position is reached if the release button jumps ahead.
- 3.3 To verify that the tracker is firmly attached, try to move and rotate the tracker. The tracker must not move in any direction.

4 Validate Instrument

Prior to instrument validation, the pointer must be validated. *Refer to step 4.1.* If pointer validation is already performed, proceed to step 4.2.

- 4.1 Precisely place the pointer's tip into the center of the validation disk placed on the left or right side of the Instrument Tracker. *Refer to the instructions for use supplied with the pointers REF 6007-011-000, REF 6003-012-000, or REF 6007-012-000.*

- 4.2 Proceed with instrument validation. With pointer and Instrument Tracker aligned with the camera, touch the instrument's validation point with the pointer's tip and press the SELECT button.

5 Detach Instrument Tracker

For instrument detachment, press the release button and slide the Instrument Tracker from the instrument interface. The release button will remain pressed until the tracker will be fixed on the instrument interface again.

Cleaning and Inspection Instructions

Cleaning Group IV.

Refer to the Guide for Cleaning, Disinfection and Steam-Based Sterilization (TD6000005750) for cleaning safety and caution notes, cleaning equipment and detailed cleaning and inspection instructions intended for instruments with electronics.

Sterilization Instructions

Refer to the Guide for Cleaning, Disinfection and Steam-Based Sterilization (TD6000005750) for detailed sterilization instructions and caution notes.

Disposal

Products and batteries that have been in contact with material of human origin may be infectious. Safely remove the batteries from the device with the necessary pre-cautionary measures. Contact your local distributor for disposal information.

To comply with European Directive 2012/19/EU on Waste Electrical and Electronic Equipment (WEEE), products and batteries must be collected separately for recycling. Do not dispose of as unsorted municipal waste. Ensure infected products are decontaminated prior to recycling.

For Use With



WARNING

Use only Stryker-approved devices unless otherwise specified.

For information related to compatible software applications, refer to the user manual of the software application.

Technical Specifications*

REF 6007-008-000 Instrument Tracker

Size: 125.85 mm [4.95 in] height,
67.0 mm [2.63 in] width,
115.0 mm [4.25 in] length

Weight¹: 420 g [14.81 oz.]

¹Values without Instrument Battery.

Material:

Aluminum (housing); PPSU (battery housing); stainless steel (interface)

Power supply:

3 V \equiv , internally powered (lithium battery CR 2)

Enclosure protection:

IPX0 Ordinary Equipment

Approvals:

CSA International cCSAus

EN / IEC 60601-1

EN / IEC 60601-1-2

ANSI/AAMI ES60601-1

CAN/CSA-C22.2 No. 60601-1

Operation:

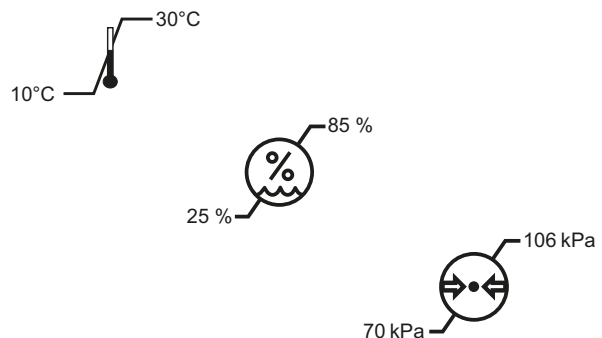

Storage and Transportation:

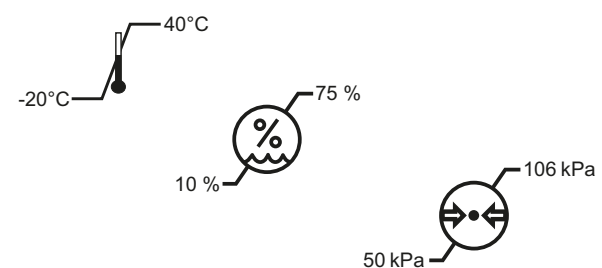

* Specifications listed are approximate and may vary slightly from unit to unit.

Troubleshooting Guidelines

Navigated instrument fails to power up when battery is installed:

- Battery is installed improperly. Reinstall battery.
- Battery power is low. Replace battery.
- Navigated instrument is damaged. Return navigated instrument for service.

Navigated instrument cannot be initialized:

- Battery is installed improperly. Reinstall battery.
- Battery power is low. Replace battery.
- Transmit LED or receiver are damaged. Return navigated instrument for service.
- SELECT button is stiff or defective. Return navigated instrument for service.

Range of movement is limited:

- One or more of the LEDs are dirty or do not function properly. Clean surface of the LEDs. If cleaning does not improve the function, return the instrument for service.

Green status light illuminates continuously:

- Battery power is low. Replace battery.

Communication with the system fails after Navigation software is restarted:

- Remove and reinsert battery. Re-initialize instrument.

Line of sight between navigated instrument and camera is interrupted:

- Navigated instrument is not visible. Remove obstruction and system will resume communication.



Tracker cannot be mounted to instrument:

- Instrument interface or tracker interface is damaged. Return for service.
- Tracker's orientation on instrument is not correct. Verify and correct orientation if necessary. See figure ② for correct orientation.
- Release button is not in pressed position. Press release button until it remains pressed and mount the tracker on instrument again.









Definition of Symbols

The following table defines the symbols used in this document, on the product and on the product label.

EN ISO 7010 Graphical symbols – Safety colors and safety signs – Registered safety signs



Symbol/ Number	Name: Definition
 W001	General warning sign: To signify a general warning.
 M002	Refer to instruction manual/booklet: To signify that the instruction manual/booklet must be read.

EN ISO 15223-1 Medical devices – Symbols to be used with medical device labels, labelling and information to be supplied – Part 1: General requirements







Symbol/ Number	Name: Definition
 5.1.1	Manufacturer: Indicates the medical device manufacturer as defined in the European Union harmonization legislation.
 5.1.3	Date of manufacture: Indicates the date when the medical device was manufactured.
 5.1.5	Batch code: Indicates the manufacturer's batch code so that the batch or lot can be identified.
 5.1.6	Catalog number: Indicates the manufacturer's catalog number so that the medical device can be identified.
 5.1.7	Serial number: Indicates the manufacturer's serial number so that a specific medical device can be identified.
 5.2.7	Non-sterile: Indicates a medical device that has not been subjected to a sterilization process.
 5.3.7	Temperature limit: Indicates the temperature limits to which the medical device can be safely exposed.
 5.3.8	Humidity limitation: Indicates the range of humidity to which the medical device can be safely exposed.

Symbol/ Number	Name: Definition
 5.3.9	Atmospheric pressure limitation: Indicates the range of atmospheric pressure to which the medical device can be safely exposed.

IEC 60417 Graphical symbols for use on equipment

Symbol/ Number	Name: Definition
 5301	Direct current: To indicate on the rating plate that the equipment is suitable for direct current only; to identify relevant terminals.
 5333	Type BF applied part: To identify a type BF applied part complying with IEC 60601-1.

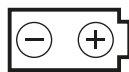
Product-specific symbols

Symbol	Name: Definition
	Quantity: Indicates the number of products in the packaging.
GTIN	Global Trade Item Number.
	Select
	Forward UP
	Backward DOWN
	Battery + positive terminal, - negative terminal
	Medical device: Indicates a medical device according to European Union harmonization legislation.



81 FR 38911 FDA Final rule for the use of symbols in labeling

Symbol	Name: Definition
Rx Only	Caution: Federal law (USA) restricts this device to sale by or on the order of a physician.

Directive 2012/19/EU on waste electrical and electronic equipment (WEEE)

Symbol	Definition
	Indicates that the product must be collected separately and must not be disposed of as unsorted municipal waste.

Regulatory marks and logos

Symbol	Definition
	Indicates that a device is in conformity with the applicable requirements set out in applicable European Union harmonization legislation providing for its affixing.
	CSA certified for Canada and USA.



Translated Equivalent: TD6007008713

U.S. Patents: www.stryker.com/patents

Stryker Corporation or its divisions or other affiliated entities own, use or have applied for the following trademarks or service marks: Leibinger, Stryker. All other trademarks are trademarks of their respective owners or holders.

Copyright © 2019 Stryker



Stryker Leibinger GmbH & Co. KG
Bötzingen Straße 41
79111 Freiburg (Germany)
t: +49 761 4512 0 (Germany)
t: +1 269 323 7700 (USA)