

[®]
stryker

Universal Battery Charger

REF 7110-120-000

Stryker F1[®] Universal Battery Charger

REF 7110-190-000

Instructions For Use

R_x ONLY

CE

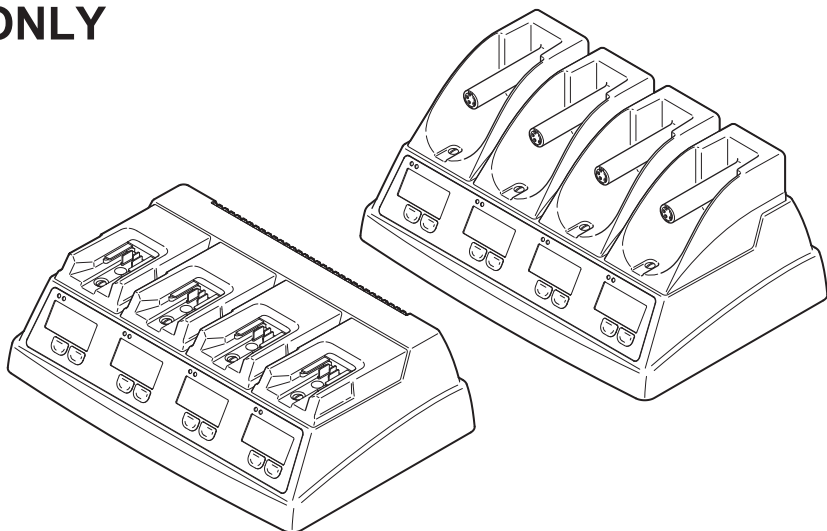

Introduction

This instructions for use manual contains information intended to ensure the safe, effective, and compliant use of your product. This manual is intended for in-service trainers, physicians, nurses, surgical technologists, and biomedical equipment technicians. Keep and consult this reference manual during the life of the product.

The following conventions are used in this manual:

- A **WARNING** highlights a safety-related issue. ALWAYS comply with this information to prevent patient and/or healthcare staff injury.
- A **CAUTION** highlights a product reliability issue. ALWAYS comply with this information to prevent product damage.
- A **NOTE** supplements and/or clarifies procedural information.

For additional information, including safety information, in-service training, or current literature, contact your Stryker sales representative or call Stryker customer service at 1-269-323-7700 or 1-800-253-3210. Outside the US, contact your nearest Stryker subsidiary.

NOTE: The user and/or patient should report any serious product-related incident to both the manufacturer and the Competent Authority of the European Member State where the user and/or patient is established.

Trademarks not the property of Stryker Corporation are the property of their respective owners.

Indications For Use

The Stryker Universal Battery Charger and Stryker F1 Universal Battery Charger (battery chargers) are four-station, modular battery chargers intended to charge Stryker handpiece battery packs only.

The battery chargers and battery packs are specifically designed to work together so that the battery charger's information screen will provide specific battery pack information.

Contraindications

None known.

Safety Directives



WARNINGS:

- Before using this equipment, or any component compatible with this equipment, read and understand the instructions for use. Pay particular attention to safety information. Become familiar with the equipment before use.
- Only healthcare professionals trained and experienced in the use of this medical device should operate this equipment.
- The Stryker Universal Battery Charger and Stryker F1 Universal Battery Charger are limited to professional use within a professional healthcare environment, excluding near high frequency (HF) surgical equipment and accessories. See the *Electromagnetic Compatibility* section.
- Upon initial receipt and before each use, operate the equipment and inspect each component for damage. DO NOT use any equipment if damage is apparent. See the *Inspection and Testing* section for inspection criteria.
- DO NOT use this equipment in areas in which flammable anesthetics or flammable agents are mixed with air, oxygen, or nitrous oxide.
- Take special precautions regarding electromagnetic compatibility (EMC) when using medical electrical equipment. Place this equipment into service according to the EMC information contained in this manual. Portable and mobile radio frequency (RF) equipment can affect the function of this equipment.
- ALWAYS use the appropriate battery charger to charge battery packs.
- DO NOT operate the battery charger using a voltage inconsistent with the rating on the back of the unit.
- DO NOT operate the battery charger with a damaged power cord or plug.

Accessories



WARNINGS:

- Use only Stryker-approved equipment, unless otherwise specified.
- DO NOT modify any equipment without the authorization of the manufacturer.
- Use only Stryker-approved electronic components and accessories. Failure to comply may result in degraded performance, increased electromagnetic emissions, or decreased electromagnetic immunity of the system.
- DO NOT use any battery charger accessory that is not recommended or sold by Stryker. Failure to comply may result in fire, electric shock, or injury.

CAUTION: ALWAYS select and install the appropriate charger module for the specific battery pack used.

NOTES:

- Four System 6™ Modules (REF 6110-625-000) are supplied with the Universal Battery Charger.
- Four Stryker F1 Charger Modules (REF 1900-125-000) are supplied with the Stryker F1 Universal Battery Charger.
- Alternative charger modules may be installed to accommodate specific types of battery packs as required.
- For a complete list of accessories, contact your Stryker sales representative. Outside the US, contact your nearest Stryker subsidiary.

The following Stryker-approved accessories are sold separately:

CHARGER MODULE	REF	FOR USE WITH BATTERY PACK REF
Charger Module*	6110-412-000	4112-000-000
System 5 Module	6110-415-000	4115-000-000
Charger Module	6110-422-000	4212-000-000 4215-000-000
Non-sterile Battery Charger Module	6110-426-000	4126-110-000 4222-110-000
System 6 Module	6110-625-000	6126-110-000 6212-000-000 6215-000-000 7126-110-000 7212-000-000 7215-000-000 7222-110-000 8212-000-000 8215-000-000
Stryker F1 Charger Module	1900-125-000	1900-012-000 1900-013-000

*This charger module is not design integrated. The battery charger will not display charge cycle count information for this charger module.

POWER CORD	REF
Source Cord	0277-702-019
European Source Cord	0590-100-002
Power Cord (general)	0996-851-XXX series

Features

Battery Charger

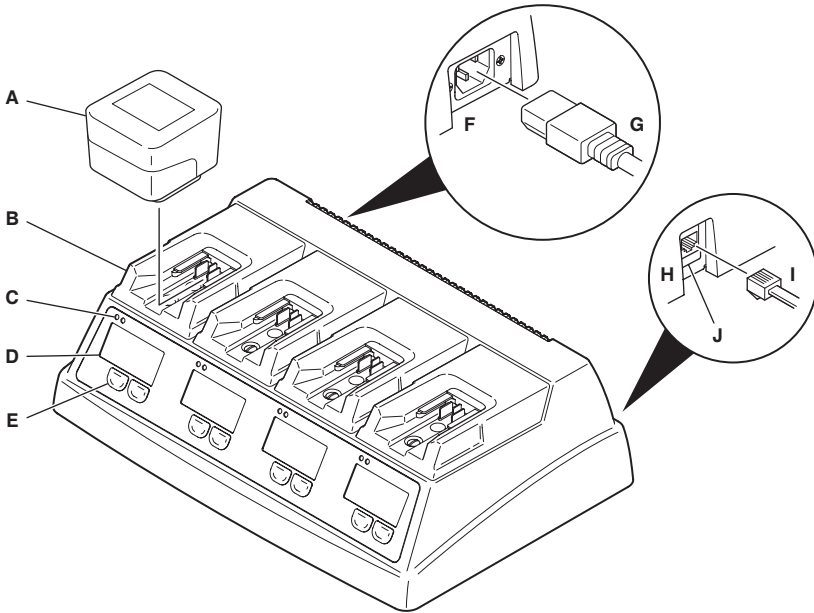

A	Battery Pack – A variety of battery packs are sold separately.
B	Charger Module – An interchangeable component designed to accept a specific type of battery pack. A variety of charger modules are sold separately.
C	Indicator Lights – Provide status information for each charger module.
D	Information Screen – Provides status information and error messages for the battery charger, charger modules, and battery packs.
E	Input Buttons – Allow the user to interact with the battery charger. The information screen displays appropriate input button labels during the battery pack charging sequence.

F	Power Cord Receptacle – Accepts the power cord.
G	Power Cord – Connects the battery charger to a hospital-grade, facility power receptacle
H	Isolated Diagnostics Port – An Ethernet receptacle used to export device usage data from the battery charger to Stryker via Stryker’s Cloud, if desired.
I	Ethernet Cable (not supplied) – Connects the isolated diagnostics port to a facility Ethernet receptacle
J	MAC ID Label – Shows the Media Access Control Identifier (MAC Address) for the battery charger.

Information Screen

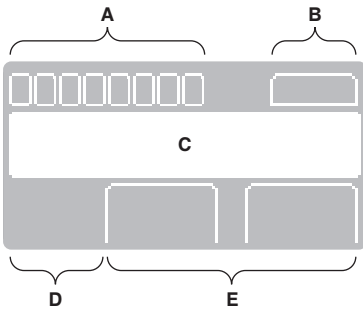

A	State-of-Health Area – Indicates charging activity, and the state-of-health of the battery pack.
B	Counter Area – Displays numeric information based on the state of the battery charger, charger modules, and/or battery packs.
C	Message Area – Displays status information and requests user action.
D	Symbol Area – Displays symbols based on the state of the battery charger, charger modules, and/or battery packs.
E	Input Button Label Area – Displays appropriate input button labels during the battery pack charging sequence.



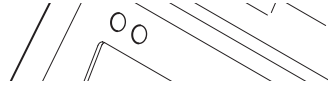



Indicator Lights



INDICATION	STATUS
GREEN (Steady State)	The battery pack is fully charged.
AMBER (Steady State)	The battery charger is either charging or discharging the battery pack.
AMBER (Slow Blinking)	The battery pack is at or near the end of its useful life.
AMBER (Fast Blinking)	The battery charger or charger module failed diagnostic testing.

Definitions

The symbols located on the equipment and/or labeling are defined in this section or in the *Symbol Definition Chart*. See the *Symbol Definition Chart* supplied with the equipment.

SYMBOL	DEFINITION
	REPLACE – The battery pack failed the state-of-health test.
	Ethernet
MAC ID	Media Access Control Identifier
	Stryker F1 battery pack orientation
	Refer to instruction manual/booklet
	General warning sign
	CSA Group certification mark for United States and Canada. These products were tested and meet medical electrical equipment certification requirements, including compliance with applicable 60601 series standards. For additional information, contact Stryker.

Instructions

To Connect the Battery Charger



WARNINGS:

- To avoid the risk of electric shock, ALWAYS connect this equipment to a hospital-grade, facility power receptacle with protective earth.
- DO NOT modify the power cord.
- ALWAYS position the equipment so that the power cord may be easily disconnected as required.
- DO NOT place the battery charger within the sterile field.
- DO NOT touch the battery charger and the patient simultaneously. Failure to comply may cause electrical shock.

CAUTION: ALWAYS place the power cord where it will not be stepped on, tripped over, or otherwise subjected to damage or stress.

1. Use the power cord to connect the battery charger to a hospital-grade, facility power receptacle (figure 1). The power-up sequence will begin:
 - A diagnostic test will be performed to ensure the battery charger and each installed charger module is operational
 - The battery charger software and hardware revision numbers will appear (figures 2 and 3)
 - The charger module revision number will appear for each installed charger module (figure 4).

NOTE: If an ERROR message appears during the power-up sequence, note the error code that appears in the counter area (figure 5). See the *Troubleshooting* section.

2. If desired, use an Ethernet cable (not supplied) to connect the isolated diagnostics port to a facility Ethernet receptacle.

NOTES:

- Confirm with a facility IT representative that the Ethernet receptacle has access to Stryker's Cloud.
- See the *Network Requirements* in the *Specifications* section.
- For more information, contact your Stryker sales representative.

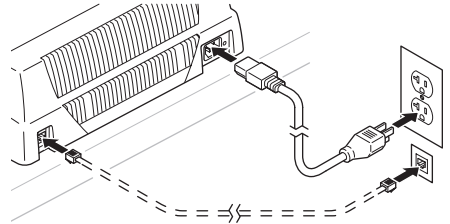

Figure 1 – Battery Charger Connections



Figure 2 – Software Revision Number

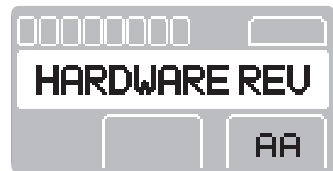

Figure 3 – Hardware Revision Number

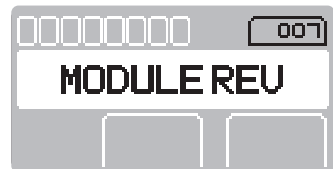

Figure 4 – Charger Module Revision Number

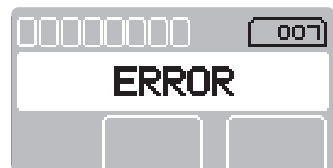

Figure 5 – Error Code

To Charge a Battery Pack

CAUTION: When battery packs require postsurgical sterilization, **ALWAYS** allow the battery packs to cool for one hour before charging. Excess heat buildup from sterilization and charging will damage the battery packs.

NOTES:

- To ensure maximum operating time, always charge battery packs before sterilization, even if the battery packs have not been used.
- The charging sequence may take between 5 and 120 minutes, based on the type of battery pack and the existing level of charge in the battery pack.
- On the Stryker F1 Universal Battery Charger, always install Stryker F1 SmartGrip® Battery Modules in the proper orientation (figure 6).

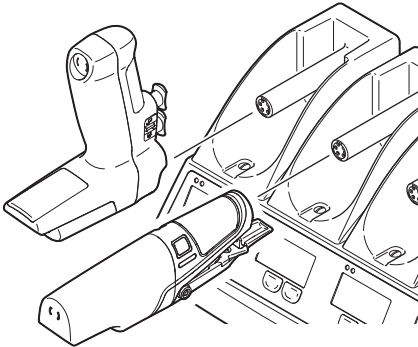

Figure 6 – Stryker F1 SmartGrip Battery Module Orientation

1. Install a clean, dry battery pack into a compatible charger module with a NO BATTERY message screen (figure 7).

The information screen will momentarily display the battery pack part number (figure 8) and the charging sequence will begin.

During the charging sequence, a CHARGING message will appear and the number of illuminated state-of-health bars will increase from left to right (figure 9).

After the battery pack is fully charged, a state-of-health test will be performed (figure 10):

- Five to eight bars will illuminate in the state-of-health area. More illuminated bars indicates a better ability of the battery pack to store energy.
- The counter area will update the charge cycle count (for design integrated components only).
- A READY message will appear.

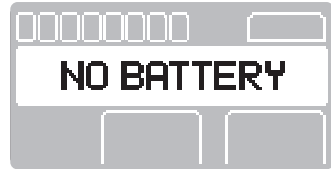

Figure 7 – No Battery Message

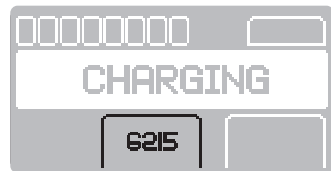

Figure 8 – Battery Pack Part Number

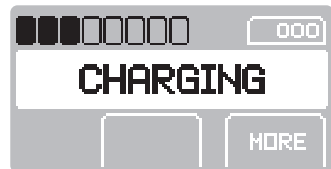

Figure 9 – Charging Message and Bars



Figure 10 – Ready Message with State-of-Health Bars and Charge Cycle Count

NOTE: If the battery pack fails the state-of-health test, a REPLACE message and symbol will appear (figure 11). See the *Troubleshooting* section.

2. Store the battery pack on the battery charger to maintain a full charge before sterilization.

To Access Over Temperature Information

NOTES:

- Specific types of battery packs allow you to access information about battery pack exposure to over temperature conditions.
 - The information screen will return to its origin after displaying an over temperature message screen for five seconds.
1. From the READY, CHARGING, or REPLACE message screen, press the MORE button to access the # of OVER TEMP message screen. The counter will display the number of times the battery pack has been exposed to an over temperature condition (figure 12).
 2. Press the MORE button again to access the TIME OVER TEMP message screen. The counter will display how much time, in minutes, the battery pack has been exposed to over temperature conditions (figure 13).

To Disconnect the Battery Charger

CAUTION: To reduce the risk of damage to the power cord, ALWAYS pull the power cord plug, not the power cord when disconnecting the battery charger.

Disconnect the battery charger from the facility power receptacle and Ethernet receptacle, as required.

To Replace a Charger Module

See the instructions for use supplied with the replacement charger module.

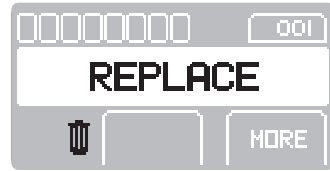

Figure 11 – Replace Message and Symbol



Figure 12 – Total Number of Over Temperature Events



Figure 13 – Total Time Exposed to Over Temperature Conditions

Cleaning

To Clean the Battery Charger and Charger Modules



WARNING: Before cleaning, ALWAYS disconnect the power cord from the facility power receptacle and the battery charger to reduce the risk of electric shock.

CAUTIONS:

- DO NOT immerse the battery charger or charger modules in liquid.
- DO NOT use solvents, lubricants, or other chemicals to clean the battery charger or charger modules unless otherwise directed.

- The use of abrasive disinfectants, such as Clorox bleach, can lead to build-up on the contacts which may affect the functionality of the charger module.
 - DO NOT allow liquid to collect in the charger modules or on top of the battery charger.
 - DO NOT allow liquid to enter the cooling vents on the back of the battery charger.
 - DO NOT spray or wipe liquid directly on the contacts of the charger modules.
 - DO NOT sterilize the battery charger or charger modules.
1. Disconnect the power cord from the facility power receptacle and the battery charger.
 2. Disconnect the Ethernet cable, if used, from the isolated diagnostics port.
 3. Gently wipe the external surfaces of the battery charger and power cord with a soft, lint-free cloth moistened with a prepared cleaning solution or non-abrasive, hospital disinfectant and water.
 4. Immediately dry the battery charger with a soft, lint-free cloth or compressed air, < 140 kPa [< 20 psi].
 5. Inspect the battery charger and power cord for damage. See the *Inspection and Testing* section for inspection criteria.

To Clean the Battery Pack

For battery pack processing instructions, see the care instructions manual supplied with the battery pack and/or a compatible handpiece.

Inspection and Testing



WARNINGS:

- Only individuals trained and experienced in the maintenance of reusable medical devices should inspect and test this equipment.
 - Before attempting any inspection and testing, ALWAYS disconnect the power cord from the battery charger to reduce the risk of electric shock.
- Perform recommended inspection and testing as indicated in these instructions.
 - DO NOT use any equipment if damage is apparent.
 - DO NOT use any system component if the inspection criteria are not met.
 - DO NOT disassemble or service this equipment. Failure to comply may result in electric shock or fire.

NOTES:

- If the equipment fails to meet the inspection and testing criteria, contact your Stryker sales representative or call Stryker customer service. Outside the US, contact your nearest Stryker subsidiary.
- Maintenance documentation for this equipment is available upon request to Stryker-authorized service personnel only.

INTERVAL	ACTIVITY	CRITERIA
Upon initial receipt and before each use	Inspect the equipment	No damage or signs of wear
		No loose or missing components
		No cuts in the power cord
		No bent pins or contacts
		No cracks in the housing

Storage and Handling

CAUTION: ALWAYS store the equipment within the specified environmental condition values throughout its useful life. See the *Specifications* section.

To ensure longevity, performance, and safety, use of the original packaging materials is recommended when storing or transporting this equipment.

Disposal/Recycle



WARNING: ALWAYS follow the current local recommendations and/or regulations governing environmental protection and the risks associated with recycling or disposing of the equipment at the end of its useful life.



In accordance with European Directive 2012/19/EU on Waste Electrical and Electronic Equipment (WEEE) as amended, product should be collected separately for recycling. Do not dispose of as unsorted municipal waste. Contact local distributor for disposal information. Ensure infected equipment is decontaminated prior to recycling.

NOTE: Contact Stryker for the recycling passport for this product.

China RoHS Standard SJ/T 11364



To comply with China RoHS Standard SJ/T 11364, this device has been marked with the environmentally-friendly use period (EFUP) number, measured in years. The device contains at least one of the listed hazardous substances above threshold.

China RoHS Disclosure Report

REF 7110-120-000, REF 7110-190-000

Part Name	Hazardous Substances					
	Lead (Pb)	Mercury (Hg)	Cadmium (Cd)	Hexavalent Chromium (Cr (VI))	Polybrominated biphenyls (PBB)	Polybrominated diphenyl ethers (PBDE)
Electronic Circuit Boards	X	O	O	O	O	O

This table is prepared in accordance with the provisions of SJ/T11364.

O: Indicates that said hazardous substance contained in all of the homogenous materials for this part is below the limit requirement of GB/T26572.

X: Indicates that said hazardous substance contained in at least one of the homogenous materials used for this part is above the limit requirement of GB/T26572.

Troubleshooting



WARNING: DO NOT disassemble or service this equipment. Failure to comply may result in electric shock or fire.

NOTE: For service, contact your Stryker sales representative or call Stryker customer service. Outside the US, contact your nearest Stryker subsidiary.

PROBLEM	COMPONENT	CAUSE	ACTION
Indicator lights do not illuminate.	Battery charger	No power to battery charger.	Reseat the cord connections on back of the battery charger and the facility power receptacle.
		Battery charger is damaged.	Return the battery charger for repair.
NO MODULE appears in the message area of the information screen.	Charger module	Charger module is not properly connected.	Reseat the charger module connectors. See the instructions for use supplied with the charger module.
		Internal problem.	Cycle the power on the charger.
			Remove and reinstall the charger module. See the instructions for use supplied with the charger module.
Charger module is damaged.	Replace the charger module.		

PROBLEM	COMPONENT	CAUSE	ACTION
NO BATTERY appears in the message area of the information screen when a battery is installed.	Battery pack	Battery pack is not properly seated in charger module.	Remove and reinstall the battery pack.
		Stryker F1 battery pack release button is not allowing proper installation.	Push the release button during installation.
		Stryker F1 battery pack is not installed in the correct orientation.	Reinstall battery pack in the correct orientation.
		Contacts are dirty or corroded.	Clean the battery pack.
	Battery pack is dead.	Replace the battery pack.	
	Charger module	Charger module is damaged.	Replace the charger module.
Message area of the information screen cycles between NO BATTERY and CHARGING.	Battery pack	Battery pack has low voltage.	Leave the battery pack on the charger module for a minimum of five minutes. If the problem persists, check other causes.
		Battery pack is dead.	Replace the battery pack.
REPLACE appears in the message area of the information screen.	Battery pack	Battery pack is wet.	Dry and reinstall the battery pack.
		Battery pack has exceeded its operational life.	Replace the battery pack.
	Charger module	Charger module contact is wet.	Dry the contact and reinstall the battery pack.
		Internal problem.	Reinsert the battery. If the REPLACE message does not occur again, then replace the charger module.
Battery pack does not fit into charger module.	Charger module	Charger module is intended for different battery pack.	Install the proper charger module. See the instructions for use supplied with the charger module.
Charger module is loose.	Charger module	Screw is not secure.	Tighten the screw.

PROBLEM	COMPONENT	CAUSE	ACTION
Battery pack becomes unusually hot during use or while charging.	Charger module	Battery pack is intended for different charger module.	Install the battery pack in the correct charger module.
	Battery pack	Internal problem.	Check battery pack status in the battery charger; replace the battery pack if indicated.
	Battery charger	Internal problem.	Return the battery charger for repair.
Information screen does not display battery pack state-of-health information.	Battery charger	The battery charger will display the battery pack state-of-health at the end of the charge cycle.	Wait until the charge cycle is complete.
Information screen does not display charge cycle count information.	Battery pack	Battery pack is not a Stryker-approved battery pack.	Use Stryker battery packs only.
	Battery pack/ Charger module	Battery pack (REF 4112-000-000) is not a design integrated component.	No action required.
Amber indicator light flashes continuously.	Battery pack/ charger module	Battery pack and/or battery charger contacts may be dirty.	Clean the contacts.
ERROR code 005 appears in the counter area of the information screen.	Battery pack	Battery pack is wet.	Dry and reinstall the battery pack.
	Charger module	Charger module contact is wet.	Dry the contact and reinstall the battery pack.
		Charger module contact is corroded.	Clean the charger module contact. If problem persists, replace the charger module.

PROBLEM	COMPONENT	CAUSE	ACTION	
ERROR code 007 appears in the counter area of the information screen.	Battery pack	Battery pack contact is corroded.	Clean the battery pack contact.	
		Battery pack contact is damaged.	Replace the battery pack.	
		Battery pack ID is not present.	Replace the battery pack.	
		Battery pack has lost smart communication function.	Replace the battery pack.	
		Battery pack was repaired by an unauthorized provider and is not programmed.	Replace the battery pack.	
		Battery pack is not a Stryker-approved battery pack.	Use Stryker battery packs only.	
	Charger module	Charger module contact is corroded.	Clean the charger module contact.	
			Replace the charger module.	
		Battery charger	Battery charger contact is corroded.	Clean the battery charger contact.
			Battery charger contact is damaged.	Return the battery charger for repair.
	ERROR code 007 appears in the counter area of the information screen for a short duration, followed by normal charging operation.	Battery charger	Internal problem.	Replace the charger module.
	Sporadic electrical interference is experienced.	Battery charger	Electrical noise is present.	Turn off all electrical equipment not in use.
Relocate electrical equipment; increase spatial distance.				
Install electrical equipment into different facility power receptacles.				

Specifications



Model:	Universal Battery Charger (REF 7110-120-000)	Stryker F1 Universal Battery Charger (REF 7110-190-000)
Dimensions:	130 mm [5.125 inch] height 257 mm [10.125 inch] width 394 mm [15.5 inch] length	193 mm [7.6 inch] height 257 mm [10.125 inch] width 394 mm [15.5 inch] length
Mass:	3.47 kg [7.65 lb]	3.47 kg [7.65 lb]
Material:	In accordance with the European REACH regulation and other environmental regulatory requirements, components within the charger contain Lead, CAS No. 7439-92-1; Diboron Trioxide, CAS No. 1303-86-2; Lead Monoxide, CAS No. 1317-36-8; and 1-Methyl-2-Pyrrolidone (NMP), CAS No. 872-50-4. This declaration is made in good faith and is either based on a technical evaluation, supplier data, and/or laboratory testing.	
Power Cord (REF 0277-702-019 and REF 0590-100-002):	2 m [78.7 inch] length, fitted with NEMA 5-15 hospital-grade plug, or 2.5 m [98.4 inch] length, fitted with CEE 7/7 plug	
Mode of Operation:	Continuous Operation	
Electrical:		
Input:	100-230 V \sim 50-60 Hz 2.2-1 A	
Output:	22 V ---	
Ingress Protection:	IPX0	
Equipment Type:	Class I	
Ground Type:	 Protective Earth Ground	
Means of Isolation from Supply Mains:	Disconnect the power cord from the battery charger power cord receptacle.	
Network Requirements:		
Purpose of the Connection:	Device Usage Data	
Required Network Characteristics:	Standard TCP/IP over Ethernet (IEEE 802.3 10/100 Mbps)	
Required Network Configuration:	DHCP server, Mask and Gateway provided by site IT admin; Access to Stryker's Cloud	
Technical Specifications of the Connection:	Standard TCP/IP over Ethernet (IEEE 802.3 10/100 Mbps), utilized industry standard https (port 443) web services communication to Stryker's Cloud.	
Intended Information Flow:	Device Usage Data	
Hazardous Situations Resulting from a Failure of the Network:	None known. CAUTION: Subsequent changes to the IT network could introduce new risks and require additional analysis. The hospital IT admin should identify, analyze, evaluate, and control these risks. Changes to the IT network include: changes in network configuration, connection of additional items, disconnection of items, update of equipment, upgrade of equipment.	

Power Cord Specifications (general) (REF 0996-851-XXX Series)

Ratings:	Current: 10 A Voltage: 250 VAC minimum Frequency: 50/60 Hz Temperature: 0 °C to 70 °C minimum Flammability: UL 94 V-2 minimum, IEC 60332-1
Conductor:	Size: 3 X 1.00 mm ² ≤ size < 3 X 1.50 mm ² Material: Copper
Connector Type:	IEC 60320 C13
Plug Type:	The facility power (mains) plug shall have a ground/earthing pin.
Cord:	Type: SJT, H05VV-F, HVCTF, RVV or equivalent (unshielded) Length: 3.0 m, 2.5 m NOTE: The 2.5 m cord is not for use in Canada or the US.
Dielectric Withstand:	1500 VAC for 60 seconds between line and protective earth, and between neutral and protective earth
Certification:	All applicable in-country medical electrical requirements

Power Cord Requirements (specific)

The Canadian and US power supply cord shall have a tag or label in English and French indicating that "GROUNDING RELIABILITY CAN ONLY BE ACHIEVED WHEN EQUIPMENT IS CONNECTED TO AN EQUIVALENT RECEPTACLE MARKED 'HOSPITAL ONLY' OR 'HOSPITAL GRADE' " or equivalent wording.

Agency Approval:  CSA Certified for Canada and US or  UL Recognized for Canada and US.

Environmental Conditions:

Temperature:

Humidity:

Atmospheric Pressure:

Operation

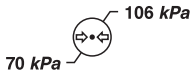
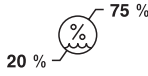
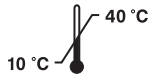

Storage and Transportation

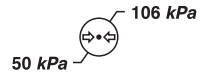
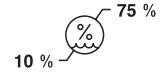
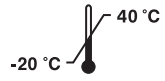

Electromagnetic Compatibility





WARNING: DO NOT stack or place equipment adjacent to the product. If such a configuration is necessary, observe the configuration to ensure that electromagnetic interference does not degrade performance.

Guidance and manufacturer's declaration - electromagnetic emissions		
The Universal Battery Charger (REF 7110-120-000) and Stryker F1 Universal Battery Charger (REF 7110-190-000) are intended for use in the electromagnetic environment specified below. The customer or the user of the Universal Battery Charger (REF 7110-120-000) and Stryker F1 Universal Battery Charger (REF 7110-190-000) should assure that they are used in such an environment.		
Emissions test	Compliance	Electromagnetic environment - guidance
RF emissions CISPR 11	Group 1	The Universal Battery Charger (REF 7110-120-000) and Stryker F1 Universal Battery Charger (REF 7110-190-000) use RF energy only for their internal function. Therefore, their RF emissions are very low and are not likely to cause any interference in nearby electronic equipment.
RF emissions	Class A	<p>NOTE: The emissions characteristics of this equipment make it suitable for use in industrial areas and hospitals (CISPR 11 class A). If it is used in a residential environment (for which CISPR 11 class B is normally required) this equipment might not offer adequate protection to radio-frequency communication services. The user might need to take mitigation measures, such as relocating or re-orienting the equipment.</p> <p>The Universal Battery Charger (REF 7110-120-000) and Stryker F1 Universal Battery Charger (REF 7110-190-000) are suitable for use in all establishments other than domestic establishments and those directly connected to the public low-voltage power supply network that supplies buildings used for domestic purposes.</p>
Harmonic emissions IEC 61000-3-2	Class A	
Voltage fluctuations/flicker emissions IEC 61000-3-3	Complies	

Guidance and manufacturer's declaration - electromagnetic immunity			
The Universal Battery Charger (REF 7110-120-000) and Stryker F1 Universal Battery Charger (REF 7110-190-000) are intended for use in the electromagnetic environment specified below. The customer or the user of the Universal Battery Charger (REF 7110-120-000) and Stryker F1 Universal Battery Charger (REF 7110-190-000) should assure that they are used in such an environment.			
Immunity test	IEC 60601 test level	Compliance level	Electromagnetic environment - guidance
Electrostatic discharge (ESD) IEC 61000-4-2	± 2 kV, ± 4 kV, ± 6 kV, ± 8 kV contact ± 2 kV, ± 4 kV, ± 8 kV, ± 15 kV air	± 2 kV, ± 4 kV, ± 6 kV, ± 8 kV contact ± 2 kV, ± 4 kV, ± 8 kV, ± 15 kV air	Floors should be wood, concrete or ceramic tile. If floors are covered with synthetic material, the relative humidity should be at least 20%.
Electrical fast transient/burst IEC 61000-4-4	± 2 kV at 100 kHz repetition frequency for power supply lines ± 1 kV at 100 kHz repetition frequency for input/output lines	± 2 kV at 100 kHz repetition frequency for power supply lines ± 1 kV at 100 kHz repetition frequency for input/output lines	Mains power quality should be that of a typical commercial or hospital environment.
Surge IEC 61000-4-5	± 0.5 , ± 1 kV line(s) to line(s) ± 0.5 , ± 1 , ± 2 kV line(s) to earth	± 0.5 , ± 1 kV line(s) to line(s) ± 0.5 , ± 1 , ± 2 kV line(s) to earth	Mains power quality should be that of a typical commercial or hospital environment.
Voltage dips, short interruptions and voltage variations on power supply input lines IEC 61000-4-11	$<5\% U_T$ ($>95\%$ dip in U_T) for 0.5 cycle $0\% U_T$ (100% dip in U_T) for 0.5 cycle at 0° , 45° , 90° , 135° , 180° , 225° , 270° , and 315° $0\% U_T$ (100% dip in U_T) for 1 cycle at 0° $40\% U_T$ (60% dip in U_T) for 5 cycles $70\% U_T$ (30% dip in U_T) for 25 & 30 cycles at 0° $<5\% U_T$ ($>95\%$ dip in U_T) for 5 s $0\% U_T$ (100% dip in U_T) for 5 s	$<5\% U_T$ ($>95\%$ dip in U_T) for 0.5 cycle $0\% U_T$ (100% dip in U_T) for 0.5 cycle at 0° , 45° , 90° , 135° , 180° , 225° , 270° , and 315° $0\% U_T$ (100% dip in U_T) for 1 cycle at 0° $40\% U_T$ (60% dip in U_T) for 5 cycles $70\% U_T$ (30% dip in U_T) for 25 & 30 cycles at 0° $<5\% U_T$ ($>95\%$ dip in U_T) for 5 s $0\% U_T$ (100% dip in U_T) for 5 s	Mains power quality should be that of a typical commercial or hospital environment. If the user of the Universal Battery Charger (REF 7110-120-000) and Stryker F1 Universal Battery Charger (REF 7110-190-000) requires continued operation during power mains interruptions, it is recommended that the Universal Battery Charger (REF 7110-120-000) and Stryker F1 Universal Battery Charger (REF 7110-190-000) be powered from an uninterruptible power supply or a battery.
Power frequency (50/60 Hz) magnetic field IEC 61000-4-8	30 A/m at 50 and 60 Hz	30 A/m at 50 and 60 Hz	Power frequency magnetic fields should be at levels characteristic of a typical location in a typical commercial or hospital environment.

NOTE: U_T is the alternating current mains voltage prior to application of the test level.

Guidance and manufacturer's declaration - electromagnetic immunity			
The Universal Battery Charger (REF 7110-120-000) and Stryker F1 Universal Battery Charger (REF 7110-190-000) are intended for use in the electromagnetic environment specified below. The customer or the user of the Universal Battery Charger (REF 7110-120-000) and Stryker F1 Universal Battery Charger (REF 7110-190-000) should assure that they are used in such an environment.			
Immunity test	IEC 60601 test level	Compliance level	Electromagnetic environment - guidance
Conducted RF IEC 61000-4-6	3 Vrms 150 kHz to 80 MHz outside ISM bands 80% AM at 1 kHz 6 Vrms 150 kHz to 80 MHz in ISM bands 80% AM at 1 kHz	3 Vrms 150 kHz to 80 MHz outside ISM bands 80% AM at 1 kHz 6 Vrms 150 kHz to 80 MHz in ISM bands 80% AM at 1 kHz	IEC 60601-1-2 3rd Edition: Portable and mobile RF equipment should be used no closer to any part of the Universal Battery Charger (REF 7110-120-000) and Stryker F1 Universal Battery Charger (REF 7110-190-000), including cables, than the recommended separation distance calculated from the equation applicable to the frequency of the transmitter. Recommended separation distance $d=1.2\sqrt{P}$ $d=1.2\sqrt{P}$ 80 MHz to 800 MHz $d=2.3\sqrt{P}$ 800 MHz to 2.5 GHz Where P is the maximum output power rating of the transmitter in watts (W) according to the transmitter manufacturer and d is the recommended separation distance in meters (m). IEC 60601-1-2 4th Edition:  WARNING: Portable RF equipment (including peripherals such as antenna cables and external antennas) should be used no closer than 30 cm (12 inches) to any part of the Universal Battery Charger (REF 7110-120-000) and Stryker F1 Universal Battery Charger (REF 7110-190-000), including cables specified by the manufacturer. Otherwise, degradation of the performance of this equipment could result. Field strengths from fixed RF transmitters, as determined by an electromagnetic site survey, ^a should be less than the compliance level in each frequency range. ^b Interference may occur in the vicinity of equipment marked with the following symbol: 
Radiated RF IEC 61000-4-3	3 V/m 80 MHz to 2.7 GHz 80% AM at 1 kHz	3 V/m 80 MHz to 2.7 GHz 80% AM at 1 kHz	

NOTE 1: At 80 MHz and 800MHz the higher frequency range applies.

NOTE 2: These guidelines may not apply in all situations. Electromagnetic propagation is affected by absorption and reflection from structures, objects and people.

^a Field strengths from fixed transmitters, such as base stations for radio (cellular/cordless) telephones and land mobile radios, amateur radio, AM and FM radio broadcast and TV broadcast cannot be predicted theoretically with accuracy. To assess the electromagnetic environment due to fixed RF transmitters, an electromagnetic site survey should be considered. If the measured field strength in the location in which the Universal Battery Charger (REF 7110-120-000) and Stryker F1 Universal Battery Charger (REF 7110-190-000) are used exceeds the applicable RF compliance level above, the Universal Battery Charger (REF 7110-120-000) and Stryker F1 Universal Battery Charger (REF 7110-190-000) should be observed to verify normal operation. If abnormal performance is observed, additional measures may be necessary, such as re-orienting or relocating the Universal Battery Charger (REF 7110-120-000) and Stryker F1 Universal Battery Charger (REF 7110-190-000).

^b Over the frequency range 150 kHz to 80 MHz, field strengths should be less than 3 V/m.

IEC 60601-1-2 3rd Edition: Recommended separation distances between portable and mobile RF equipment and the Universal Battery Charger (REF 7110-120-000) and Stryker F1 Universal Battery Charger (REF 7110-190-000)			
The Universal Battery Charger (REF 7110-120-000) and Stryker F1 Universal Battery Charger (REF 7110-190-000) are intended for use in the electromagnetic environment in which radiated RF disturbances are controlled. The customer or the user of the Universal Battery Charger (REF 7110-120-000) and Stryker F1 Universal Battery Charger (REF 7110-190-000) can help prevent electromagnetic interference by maintaining a minimum distance between portable and mobile RF equipment (transmitters) and the Universal Battery Charger (REF 7110-120-000) and Stryker F1 Universal Battery Charger (REF 7110-190-000) as recommended below, according to the maximum output power of the equipment.			
Rated maximum output power of transmitter W	Separation distance according to frequency of transmitter m		
	150 kHz to 80 MHz $d=1.2\sqrt{P}$	80 MHz to 800 MHz $d=1.2\sqrt{P}$	800 MHz to 2.5 GHz $d=2.3\sqrt{P}$
0.01	0.12	0.12	0.23
0.1	0.38	0.38	0.73
1	1.2	1.2	2.3
10	3.8	3.8	7.3
100	12	12	23

For transmitters rated at a maximum output power not listed above, the recommended separation distance d in meters (m) can be estimated using the equation applicable to the frequency of the transmitter, where P is the maximum output power rating of the transmitter in watts (W) according to the transmitter manufacturer.

NOTE 1: At 80 MHz and 800MHz, the separation distance for the higher frequency range applies.

NOTE 2: These guidelines may not apply in all situations. Electromagnetic propagation is affected by absorption and reflection from structures, objects and people.

ES/DE/FR/IT/NL	7110-120-710
JA/ZH/KO	7110-120-720
SV/DA/FI/PT/NO	7110-120-730
PL/EL	7110-120-750
TR	7210-120-762
RU	7210-120-770



Stryker Instruments

1941 Stryker Way
Portage, Michigan
(USA) 49002
1-269-323-7700
1-800-253-3210

stryker[®]