

<p>NOTE: This portion of the document should not appear on produced Labels or IFUs.</p> <p>Stryker Instruments (269) 323-7700 (800) 253-3210</p>	<p><u>Dimensions:</u> 6 inch (width) x 6 inch Booklet</p>	<p><u>Color/Material/Finish:</u> Color Graphics on White Background 20# Bond or Equivalent</p>	<p><u>Label Stock:</u> N/A</p>	
	<p><u>Print Location:</u> Print Center</p>	<p><u>Suppliers/Services:</u> N/A</p>	<p><u>Description/Type:</u> Instructions For Use</p>	
			<p><u>Part Number:</u> 6205-001-700</p>	<p><u>Rev.</u> D</p>

[®]
stryker

System 6 Dual Trigger Rotary Handpiece

REF 6205-000-000

Instructions For Use

R_x ONLY

CE 0197

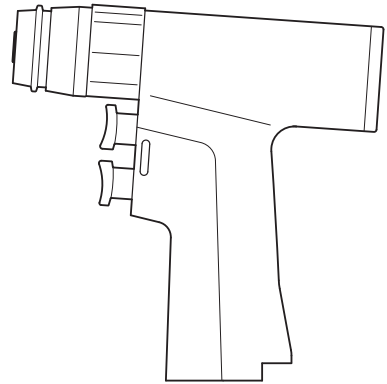

ENGLISH (EN)

Introduction

This *Instructions For Use* manual is the most comprehensive source of information for the safe and effective use of your product. This manual may be used by in-service trainers, physicians, nurses, surgical technologists, and biomedical equipment technicians. Keep and consult this reference manual during the life of the product.

The following conventions are used in this manual:

- A **WARNING** highlights a safety-related issue. ALWAYS comply with this information to prevent patient and/or healthcare staff injury.
- A **CAUTION** highlights a product reliability issue. ALWAYS comply with this information to prevent product damage.
- A **NOTE** supplements and/or clarifies procedural information.

For additional information, especially safety information, or in-service training, contact your Stryker sales representative or call Stryker customer service. Outside the US, contact your nearest Stryker subsidiary.

Indications For Use

The Stryker System 6 Battery Powered Heavy Duty Dual Trigger Rotary Handpiece, when used with a variety of attachments, is intended for surgical procedures involving drilling, reaming, driving wire or pins, cutting bone and hard tissue.

Contraindications

None known.

User/Patient Safety



WARNINGS:

- Only trained and experienced healthcare professionals should use this equipment. Before using any system component or any component compatible with this system, read and understand the instructions. Pay particular attention to WARNING information. Become familiar with the system components prior to use.
- The healthcare professional performing any procedure is responsible for determining the appropriateness of this equipment and the specific technique used for each patient. Stryker, as a manufacturer, does not recommend surgical procedure or technique.
- Upon initial receipt and before each use, operate the equipment and inspect each component for damage. DO NOT use any component if damage is apparent.
- Upon initial receipt and before each use, clean and sterilize the equipment as indicated. See the care instructions manual supplied with the equipment.
- Perform recommended maintenance as indicated. Only trained and experienced healthcare professionals should maintain this equipment. See the care instructions manual supplied with the equipment.

- ALWAYS operate the equipment within the specified environmental condition values. See the *Specifications* section.
- ALWAYS follow the recommended duty cycle to prevent the equipment from overheating. See the *Specifications* section and/or the instructions for use supplied with the attachment.
- DO NOT use this equipment in areas in which flammable anesthetics or flammable agents are mixed with air, oxygen, or nitrous oxide.
- Take special precautions regarding electromagnetic compatibility (EMC) when using medical electrical equipment like the handpiece. Install and place the handpiece into service according to the EMC information in this manual. Portable and mobile RF communications equipment can affect the function of the handpiece.
- DO NOT reuse, reprocess, or repackage single use cutting accessories. All cutting accessories are intended for a single use only. Reuse may create a serious risk of contamination and lead to infection or cross-infection. Reprocessing may compromise the structural integrity of the cutting accessory and result in fragmentation during use. Critical product information may be lost if the cutting accessory is repackaged.

NOTE: For a complete list of accessories, contact your Stryker sales representative or call Stryker customer service. Outside the US, contact your nearest Stryker subsidiary.

The following Stryker-approved accessories are sold separately:

DESCRIPTION	REF
Small Battery Pack	6212-000-000
Large Battery Pack	6215-000-000
Aseptic Battery Kit	6126-000-000
Small Aseptic Battery Kit	6127-000-000

Accessories



WARNINGS:

- Use only Stryker-approved system components and accessories, unless otherwise specified. Using other accessories may result in increased electromagnetic emissions or decreased electromagnetic immunity of the system. DO NOT modify any system component or accessory.

Features

Handpiece

- **Battery Latch** - To release the battery pack from the handpiece, depress the battery latch.
- **Battery Pack** - Rechargeable battery pack provides power to the handpiece.
- **Reverse Trigger** - To cause counterclockwise rotation and vary speed, press this pressure-sensitive trigger.
- **Forward Trigger** - To cause clockwise rotation and vary speed, press this pressure-sensitive trigger.
- **F/R/Safe Control** - Based on its position, allows the handpiece to operate in forward, reverse, or oscillate mode; the safe mode position prevents the inadvertent operation of the handpiece.
- **Actuating Collar** - To release the attachment, slide the actuating collar.
- **Shifter Knob** - To select the handpiece mode of REAM (slow) or DRILL (fast), rotate the knob to the appropriate position, as required.
- **Accessory Interface** - Connector provides power and communication for future accessories.
- **Attachment** - A variety of attachments are available for use with this handpiece. Each attachment has a specialized retainer for wires, pins, tools and/or cutting accessories.
- **Applied Parts** - The distal end of the handpiece and the attachment (as defined by the standards listed in the *Specifications* section under *Product Safety Certification*).

NOTE: Press both triggers simultaneously to operate the handpiece in the oscillate mode.

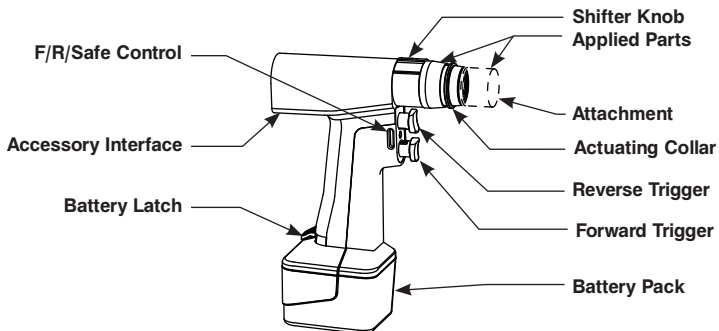

F/R/Safe Control



Forward/Reverse Mode – Fully extend the F/R/Safe control to unlock both triggers. Both triggers are functional.



Forward Mode – Fully depress the F/R/Safe control to lock the reverse trigger. The forward trigger is functional.



Safe Mode – Center the F/R/Safe control to lock both triggers.

Shifter Knob

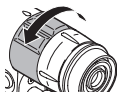

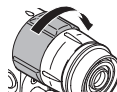

DRILL Mode – For fast speed and low torque, rotate shifter knob to DRILL.



REAM Mode – For slow speed and high torque, rotate shifter knob to REAM.

Definitions

The symbols located on the equipment and/or labeling are defined in this section or in the *Symbol Definition Chart*. See the *Symbol Definition Chart* supplied with the equipment.

SYMBOL	DEFINITION
R	Reverse Trigger
	Oscillate Mode
F	Forward Trigger
DRILL	DRILL
	General warning sign

SYMBOL	DEFINITION
F	Forward Mode
S	Safe Mode
FIR	Forward/Reverse Mode
REAM	REAM
	Per European Union Directive 2012/19/EU, product must be collected separately. Do not dispose of as unsorted municipal waste. Contact local distributor for disposal information.

Instructions

To Install Attachment



WARNING: To prevent inadvertent running of the handpiece, ALWAYS place the F/R/Safe control in the safe mode position before installing or removing any attachment.

NOTE: Several attachments are available and each has a specialized accessory retainer.

1. Slide the F/R/Safe control to the safe mode position.
2. To install an attachment, align the driveshaft of the attachment with the handpiece spindle. If the attachment has notches, also align the notches with the tabs in the sleeve of the handpiece (see figure 1).

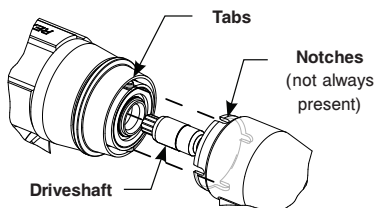

Figure 1 – To Install Attachment

3. Once properly aligned, insert the attachment into the handpiece until the attachment “snaps” into place.
4. Tug the attachment to ensure it is secure.
5. Install the desired cutting accessory. See the instructions for use manual for the attachment.

To Install Battery Pack

NOTES:

- This handpiece is designed to accept a Stryker Large or Small Battery Pack only (REF 6215-000-000 or REF 6212-000-000). These battery packs can be charged in the Stryker System 6 Battery Charger (REF 6110-120-000) or the Universal Battery Charger (REF 7110-120-000) configured with the appropriate battery charger modules.
 - See the instructions for use supplied with the battery charger and/or battery pack for charging details and specifications.
1. Slide a fully charged battery pack firmly into the handpiece until the battery latch snaps, indicating the battery pack is secure (see figure 2).

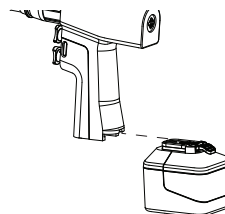

Figure 2 – To Install Battery Pack

2. Test the operation of the handpiece by sliding the F/R/Safe control to FORWARD (F) or FORWARD/REVERSE (F/R) and squeezing the trigger.
3. Slide the F/R/Safe control to the safe mode position until you are ready to use the handpiece.

To Operate Handpiece



WARNINGS:

- ALWAYS place the F/R/Safe control in the safe mode position while the handpiece is idle, before installing or removing any accessory, or when passing the handpiece to another person.
- A wobbling attachment may cause bone or tissue damage or inaccurate wiring or pin placement. If wobbling occurs, see the *Troubleshooting* section.
- DO NOT apply excessive pressure, such as bending or prying, with a cutting accessory to prevent fracturing the accessory. Applying excessive pressure, especially during high operating speeds, may cause the cutting accessory to bend significantly and result in tissue damage, loss of tactile control and the ejection of cutting accessory pieces at a high velocity.

CAUTIONS:

- DO NOT stall the handpiece. Failure to comply may damage the electric motor and/or battery pack. If the handpiece jams, release the trigger immediately. Remove any obstructions before continuing the procedure.
 - If any power loss is experienced while using a handpiece, ALWAYS replace the battery pack with a fully charged battery pack. Failure to comply may result in a drained or damaged battery pack with a shortened life.
1. Slide the F/R/Safe control to the appropriate position to allow the handpiece to operate in the forward, reverse or oscillate mode.
 2. Squeeze the appropriate pressure sensitive trigger for variable speed operation. For oscillation, squeeze both triggers simultaneously.
 3. Slide the F/R/Safe control to the safe mode position when you are finished operating the handpiece.

To Change Handpiece Mode



WARNINGS:

- DO NOT change the handpiece mode while operating the handpiece.
 - DO NOT use a reamer in the handpiece and operate the handpiece in the DRILL mode. Failure to comply may cause wobble and result in patient and/or healthcare staff injury.
1. Ensure the handpiece is not running.
 2. Change the handpiece mode as follows:
 - For DRILL mode, rotate the shifter knob counterclockwise until it clicks in place.

- For REAM mode, rotate the shifter knob clockwise until it clicks in place.
3. Test the operation of the handpiece.
 4. Slide the F/R/Safe control to the safe mode position until you are ready to use the handpiece.

To Remove Attachment

1. Slide the F/R/Safe control to the safe mode position.
2. Slide the actuating collar back to release the attachment.

To Remove Battery Pack

Depress the battery latch and pull the battery pack out of the handpiece.

Troubleshooting



WARNING: DO NOT disassemble or service this equipment.

NOTE: For service, contact your Stryker sales representative or call Stryker customer service. Outside the US, contact your nearest Stryker subsidiary.

PROBLEM	CAUSE	ACTION
Handpiece does not run or turns at a reduced speed.	Battery pack is discharged.	Recharge the battery pack in Stryker battery charger.
	Battery pack is expended.	Replace the battery pack.
	F/R/Safe control is in the safe mode position.	Slide F/R/Safe control to the forward or forward/reverse mode position.
	Drivetrain is malfunctioning.	Return the handpiece for repair.

PROBLEM	CAUSE	ACTION
Motor runs but cutting accessory does not move.	Drivetrain is malfunctioning.	Return the handpiece for repair.
	Attachment is not fully seated.	Remove and insert the attachment. Ensure the attachment is fully seated.
	Shifter knob is positioned between the DRILL and REAM selections.	Position shifter knob to either the DRILL or REAM position.
Battery pack becomes unusually hot during use.	Circuitry is malfunctioning.	Check the battery pack on the charger. Replace the battery pack if required. See the instructions for use supplied with the battery charger.
Attachment will not fit into the handpiece.	Debris is on the attachment or inside the front end of the handpiece.	Clean the attachment and/or handpiece with a small brush with stiff, non-metallic bristles.
	Attachment is damaged.	Return the attachment for repair.
	Handpiece is damaged.	Return the handpiece for repair.
Attachment and/or cutting accessory wobbles in handpiece.	Cutting accessory or wire/pin is bent, extends too far from the distal end of attachment, is the wrong size, or is not properly centered in the attachment.	Reinsert the cutting accessory, wire or pin. If wobble persists, return the handpiece and attachment for repair.
	A reamer is installed and the handpiece is in the DRILL mode.	ALWAYS operate reamers in the REAM mode.
Handpiece has become noisy and vibrates.	Drivetrain is malfunctioning.	Return the handpiece for repair.
Sporadic electrical interference is experienced.	Electrical noise is present.	Turn off all electrical equipment not in use in the operating room.
		Relocate electrical equipment; increase spatial distance.
		Plug operating room equipment into different operating room outlets.

Care Instructions

For processing instructions and disposal/recycle information, see the care instructions manual supplied with the equipment.

Specifications



WARNING: ALWAYS check any documentation that accompanies attachments, burs, pins, and/or blades for special duty cycle and usage instructions.

NOTE: Specifications are approximate and may vary between devices or as a result of power supply fluctuations.

Model:	System 6 Dual Trigger Rotary Handpiece (REF 6205-000-000)
Dimensions:	8.6 inch [219 mm] height (with large battery pack) 1.5 inch [38 mm] width 6.0 inch [153 mm] length
Mass:	3.5 lb [1.6 kg] (with large battery pack)
Speed:	1200 rpm (drill); 270 rpm (ream)
Mode of Operation:	Non-continuous Operation
Duty Cycle:	1 minute on/4 minutes off, 3 times
Rest Between Cycles:	3 hours
Equipment Type:	 Type BF Applied Part
Maximum Temperature of Applied Parts:	Less than 124 °F [51 °C] (Maximum surface temperature as tested to the standards listed under <i>Product Safety Certification</i> .)
Power Supply:	Internally Powered 9.6 V --- (Direct current)
Ingress Protection:	IPX0 Ordinary Equipment

**Product Safety
Certification:**

CSA International

International Electrotechnical Commission

IEC 60601-1:2005, *Medical Electrical Equipment – Part 1: General Requirements for Basic Safety and Essential Performance*; IEC Corrigendum 1 (2006); IEC Corrigendum 2 (2007)

IEC 60601-1:1988, *Medical Electrical Equipment – Part 1: General Requirements for Safety - Second Edition*; Amendment 1 (1991); Amendment 2 (1995); Corrigendum 1 (1995)

Canadian Standards Association

CAN/CSA-C22.2 No. 60601-1:08, *Medical Electrical Equipment – Part 1: General Requirements for Basic Safety and Essential Performance*

CAN/CSA-C22.2 No. 601.1-M90, *Medical Electrical Equipment – Part 1: General Requirements for Safety*

**American National Standards Institute | Association for the Advancement of
Medical Instrumentation**

ANSI/AAMI ES60601-1:2005, *Medical Electrical Equipment – Part 1: General Requirements for Basic Safety and Essential Performance*; Consolidated Reprint (2009); Amendment 2 (2010)

Underwriters Laboratories

UL 60601-1, *Medical Electrical Equipment, Part 1: General Requirements for Safety – First Edition*; Revisions through and including April 26, 2006

European Committee for Electrotechnical Standardization (CENELEC)

EN 60601-1:2006, *Medical Electrical Equipment – Part 1: General Requirements for Basic Safety and Essential Performance*; IEC Corrigendum 1 (2006); IEC Corrigendum 2 (2007); CENELEC Corrigendum (2010)

Specifications (continued)

Environmental Conditions:

Temperature Limitation:

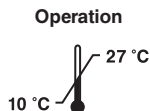

Storage and Transportation



Humidity Limitation:



Atmospheric Pressure Limitation:

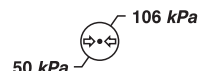
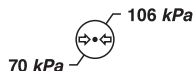

Guidance and manufacturer's declaration - electromagnetic emissions

The System 6 Dual Trigger Rotary Handpiece (REF 6205-000-000) is intended for use in the electromagnetic environment specified below. The customer or the user of the System 6 Dual Trigger Rotary Handpiece (REF 6205-000-000) should assure that it is used in such an environment.

Emissions test	Compliance	Electromagnetic environment - guidance
RF emissions CISPR 11	Group 1	The System 6 Dual Trigger Rotary Handpiece (REF 6205-000-000) uses RF energy only for its internal function. Therefore, its RF emissions are very low and are not likely to cause any interference in nearby electronic equipment.
RF emissions	Class B	The System 6 Dual Trigger Rotary Handpiece (REF 6205-000-000) is suitable for use in all establishments other than domestic and those directly connected to the public low-voltage power supply network that supplies buildings used for domestic purposes.
Harmonic emissions IEC 61000-3-2	N/A	
Voltage fluctuations/flicker emissions IEC 61000-3-3	N/A	

Guidance and manufacturer's declaration - electromagnetic immunity			
The System 6 Dual Trigger Rotary Handpiece (REF 6205-000-000) is intended for use in the electromagnetic environment specified below. The customer or the user of the System 6 Dual Trigger Rotary Handpiece (REF 6205-000-000) should assure that it is used in such an environment.			
Immunity test	IEC 60601 test level	Compliance level	Electromagnetic environment - guidance
Electrostatic discharge (ESD) IEC 61000-4-2	±6 kV contact ±8 kV air	± 6 kV contact ± 8 kV air	Floors should be wood, concrete or ceramic tile. If floors are covered with synthetic material, the relative humidity should be at least 30 %.
Electrical fast transient/burst IEC 61000-4-4	±2 kV for power supply lines ±1 kV for input/output lines	N/A	N/A
Surge IEC 61000-4-5	±1 kV line(s) to line(s) ±2 kV line(s) to earth	N/A	N/A
Voltage dips, short interruptions and voltage variations on power supply input lines IEC 61000-4-11	<5 % U_T (>95 % dip in U_T) for 0,5 cycle 40 % U_T (60 % dip in U_T) for 5 cycles 70 % U_T (30 % dip in U_T) for 25 cycles <5 % U_T (>95 % dip in U_T) for 5 sec	N/A	N/A
Power frequency (50/60 Hz) magnetic field IEC 61000-4-8	3 A/m	3 A/m	Power frequency magnetic fields should be at levels characteristic of a typical location in a typical commercial or hospital environment.

NOTE: U_T is the alternating current mains voltage prior to application of the test level.

Guidance and manufacturer's declaration - electromagnetic immunity			
The System 6 Dual Trigger Rotary Handpiece (REF 6205-000-000) is intended for use in the electromagnetic environment specified below. The customer or the user of the System 6 Dual Trigger Rotary Handpiece (REF 6205-000-000) should assure that it is used in such an environment.			
Immunity test	IEC 60601 test level	Compliance level	Electromagnetic environment - guidance
Conducted RF IEC 61000-4-6	3 Vrms 150 kHz to 80 MHz	N/A	<p>Portable and mobile RF communications equipment should be used no closer to any part of the System 6 Dual Trigger Rotary Handpiece (REF 6205-000-000), including cables, than the recommended separation distance calculated from the equation applicable to the frequency of the transmitter.</p> <p>Recommended separation distance: $d = 1.2\sqrt{P}$ 80 MHz to 800 MHz $d = 2.3\sqrt{P}$ 800 MHz to 2,5 GHz</p> <p>Where P is the maximum output power rating of the transmitter in watts (W) according to the transmitter manufacturer and d is the recommended separation distance in meters (m). Field strengths from fixed RF transmitters, as determined by an electromagnetic site survey^a, should be less than the compliance level in each frequency range^b.</p> <p>Interference may occur in the vicinity of equipment marked with the following symbol:</p>  (Non-ionizing electromagnetic radiation)
Radiated RF IEC 61000-4-3	3 V/m 80 MHz to 2,5 GHz	3 V/m	

NOTE 1: At 80 MHz and 800 MHz, the higher frequency range applies.

NOTE 2: These guidelines may not apply in all situations. Electromagnetic propagation is affected by absorption and reflection from structures, objects and people.

^a Field strengths from fixed transmitters, such as base stations for radio (cellular/cordless) telephones and land mobile radios, amateur radio, AM and FM radio broadcast and TV broadcast cannot be predicted theoretically with accuracy. To assess the electromagnetic environment due to fixed RF transmitters, an electromagnetic site survey should be considered. If the measured field strength in the location in which the System 6 Dual Trigger Rotary Handpiece (REF 6205-000-000) is used exceeds the applicable RF compliance level above, the System 6 Dual Trigger Rotary Handpiece (REF 6205-000-000) should be observed to verify normal operation. If abnormal performance is observed, additional measures may be necessary, such as re-orienting or relocating the System 6 Dual Trigger Rotary Handpiece (REF 6205-000-000).

^b Over the frequency range 150 kHz to 80 MHz, field strengths should be less than 3 V/m.

Recommended separation distances between portable and mobile RF communications equipment and the System 6 Dual Trigger Rotary Handpiece (REF 6205-000-000)

The System 6 Dual Trigger Rotary Handpiece (REF 6205-000-000) is intended for use in the electromagnetic environment in which radiated RF disturbances are controlled. The customer or the user of the System 6 Dual Trigger Rotary Handpiece (REF 6205-000-000) can help prevent electromagnetic interference by maintaining a minimum distance between portable and mobile RF communications equipment (transmitters) and the System 6 Dual Trigger Rotary Handpiece (REF 6205-000-000) as recommended below, according to the maximum output power of the communications equipment.

Rated maximum output power of transmitter W	Separation distance according to frequency of transmitter m		
	150 kHz to 80 MHz	80 MHz to 800 MHz $d = 1.2\sqrt{P}$	800 MHz to 2,5 GHz $d = 2.3\sqrt{P}$
0,01	N/A	0.12	0.23
0,1	N/A	0.38	0.73
1	N/A	1.2	2.3
10	N/A	3.8	7.3
100	N/A	12	23

For transmitters rated at a maximum output power not listed above, the recommended separation distance d in meters (m) can be estimated using the equation applicable to the frequency of the transmitter, where P is the maximum output power rating of the transmitter in watts (W) according to the transmitter manufacturer.

NOTE 1: At 80 MHz and 800 MHz, the separation distance for the higher frequency range applies.

NOTE 2: These guidelines may not apply in all situations. Electromagnetic propagation is affected by absorption and reflection from structures, objects and people.

ES/DE/FR/IT/NL	6205-001-710
JA/ZH/KO	6205-001-720
SV/DA/FI/PT/NO	6205-001-730
PL/EL/TR	6205-001-750



Stryker Instruments

4100 E. Milham
Kalamazoo, Michigan
(USA) 49001
1-269-323-7700
1-800-253-3210

stryker[®]