

<p>NOTE: This portion of the document should not appear on produced Labels or IFUs.</p> <p>Stryker Instruments (269) 323-7700 (800) 253-3210</p>	<b><u>Dimensions:</u></b>	<b><u>Color/Material/Finish:</u></b>	<b><u>Label Stock:</u></b>	
			<b><u>Description/Type:</u></b>	
	<b><u>Print Location:</u></b>	<b><u>Suppliers/Services:</u></b>	<b><u>Part Number:</u></b>	<b><u>Rev.</u></b>

IMPORTANT INFORMATION: File in your records

**stryker**  
*SYSTEM 5*

## Rotary Handpiece

INSTRUCTIONS FOR USE

REF 4203-000-000

**R<sub>x</sub> ONLY**

**CE** 0197

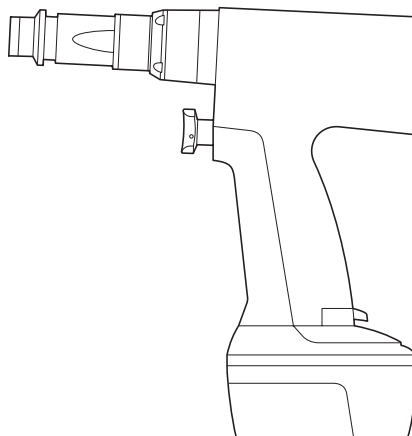

US Patents: 5,747,953  
6,013,991

## Important Information

### WARNING - CAUTION - NOTE

Please read this manual and follow its instructions carefully. The words WARNING, CAUTION and NOTE carry special meanings and should be carefully reviewed.

**WARNING:** The personal safety of the patient and user may be involved. Disregarding this information could result in injury to the patient and/or user.

**CAUTION:** These instructions point out special service procedures or precautions that must be followed to avoid damaging the instrument.

**NOTE:** This provides special information to make maintenance easier or important instructions clearer.



An exclamation point within a triangle displayed on the product is intended to alert the user to the presence of important operating and maintenance instructions in this manual.

Hudson is a trademark and/or registered trademark of Hudson Respiratory Care Co.

AO is a trademark and/or registered trademark of AO Technology AG.

## Intended Use

The Stryker System 5 Battery Powered Heavy Duty Rotary Handpiece, when used in conjunction with a number of attachments, is intended for orthopedic surgical procedures involving drilling, reaming, driving wire or pins, cutting bone and hard tissue.

## Accessories

DESCRIPTION	REF
Battery Pack	4115-000-000, 4116-000-000, 4126-000-000
1:1 1/4" Keyed Chuck	4103-131-000
2:1 High Torque 1/4" Drill	4103-180-000
3.25:1 1/4 " Keyed Chuck	4103-231-000
1:1 Trinkle	4103-160-000
3.25:1 Trinkle	4103-260-000
1:1 AO Small Drill	4103-110-000
3.25:1 AO Large Reamer	4103-210-000
1:1 Hudson	4103-113-000
1:1 Hudson Modified Trinkle	4103-135-000
3.25:1 Hudson	4103-213-000
3.25:1 Hudson/Modified Trinkle	4103-235-000
4:1 Hudson/Modified Trinkle	4103-435-000
Keyless Chuck Adaptor	4103-082-131
1:1 Keyless Drill	4103-133-000

A list of cutting accessories is available from your Stryker Instruments sales representative.

## User/Patient Safety\*



### WARNINGS:

- Read and understand the information in this manual. Familiarization with the Stryker System 5 Battery Powered Instruments prior to use is important.
  - Prior to each use, operate system components and inspect for damage. DO NOT use if damage is apparent. Take special precaution regarding electromagnetic compatibility (EMC) when using medical electrical equipment like the System 5 handpiece. Install and place the handpiece into service according to the EMC information in this manual. Portable and mobile RF communications equipment, such as wireless phones, can affect the function of the handpiece.
  - Use only Stryker approved accessories. Other accessories may result in increased emissions or decreased immunity of the system. Contact your Stryker sales representative for a complete list of accessories. DO NOT modify any accessory. Failure to comply may result in patient and/or operating room staff injury.
  - Prior to each use, system components should be operated and inspected for any loose components or damage. DO NOT use if these conditions exist. Loose components could fall off the handpiece into the wound site causing potential patient injury.
  - Clean and sterilize handpieces, attachments and batteries before first and every use.
  - This equipment is not suitable for use in the presence of flammable anesthetic mixture with air or with oxygen or nitrous oxide.
- Avoid unintentional operation of the handpiece. A handpiece that contains a battery should always be placed in the SAFE mode while it is either sitting idle or an accessory is being attached or removed. Remove the battery pack from the handpiece when the instrument is not in use.
  - Use only Stryker approved components and accessories unless otherwise specified. DO NOT modify any accessory to fit a handpiece. Failure to comply may result in patient and/or operating room staff injury.
  - DO NOT service handpieces, attachments, or battery packs. These products contain no parts that the user can service.
  - If “wobble” is encountered while using an attachment, this likely indicates that the bit is bent, extends too far from the distal end of the accessory, is the wrong size, or is not properly centered in the accessory. Reinsert the bit. If “wobble” persists, and is not due to a bent bit, this may indicate a problem with the attachment. Return the attachment to Stryker for inspection and repair.

### CAUTIONS:

- DO NOT stall the handpiece to prevent damaging the electric motor and/or battery pack. If the handpiece jams, release the trigger immediately. Remove any obstructions before continuing the procedure.
- Do not immerse the handpiece or battery pack. Water may enter the casing and damage the electrical components.

\*For further information, contact your Stryker Instruments sales representative or Customer Service at 1-800-253-3210. Outside the USA, contact your nearest Stryker subsidiary.

## Features and Functions

- **Battery Latch** - Depress the latch to release the battery pack from the handpiece.
- **Battery Pack** - Contains rechargeable battery that provides power to the handpiece.
- **Trigger Switch** - The trigger is pressure sensitive for variable speed operation. The switch is integrated with the trigger and prevents inadvertent operation of the handpiece. When rotated, the trigger switch allows the cutting tool to operate in forward or reverse mode.
- **Attachment** - Several attachments are available and each has a specialized accessory retainer.
- **Actuator Button** - The sliding actuator button releases the attachment.

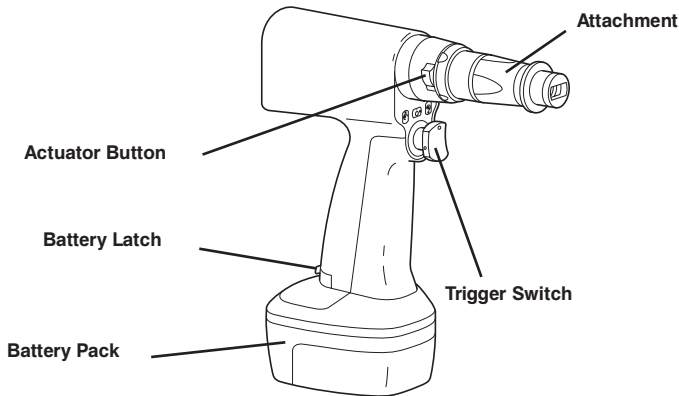

## Symbol Definitions



**FORWARD**

Setting the trigger switch to the FORWARD (F) position allows the handpiece to run clockwise while the trigger is depressed.



**SAFE**

Setting the trigger switch to the SAFE (O) position locks the trigger and prevents inadvertent operation of the handpiece; the handpiece cannot be operated.



**REVERSE**

Setting the trigger switch to the REVERSE (R) position allows the handpiece to run counterclockwise while the trigger is depressed.

## Instructions

### Attachment Installation



#### WARNING:

Always place the trigger switch in the *SAFE* position before attaching or removing any attachment to prevent inadvertent running of the handpiece.

1. Set the trigger switch to the *SAFE* position.
2. Position the attachment's J-notch while inserting the attachment with a gradual rotating motion until it "snaps" into place (see figure 1).

NOTE: If resistance is felt while installing the attachment, rotate the nose of the attachment until it properly aligns and allows the attachment to slide into place.

3. Tug the attachment to ensure it is secure.
4. Install the desired accessory. See *Attachments* for details.

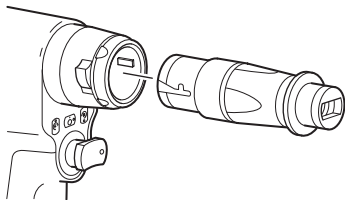

Figure 1 Attachment Installation

### Battery Pack Installation

#### NOTES:

- The Rotary Handpiece is designed to accept REF 4115-000-000, REF 4116-000-000, or REF 4126-110-000 batteries. These batteries may be charged in the System 4 Battery Charger configured with Charger Module REF 4110-415-000, REF 4110-416-000, or REF 4110-426-000 respectively. The REF 4115-000-000 battery may also be charged in the System 2000 Charger with Battery Adaptor (REF 4110-115-000).
  - Refer to the instructions supplied with the battery charger and/or battery for charging details and specifications.
1. Slide a fully charged battery pack firmly into the handpiece until the battery latch snaps, indicating the pack is secure (see figure 2).
  2. Test the operation of the handpiece by setting the trigger switch to the *FORWARD* (F) or *REVERSE* (R) position and squeezing the trigger.

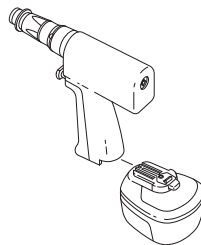

Figure 2 Battery Pack Installation

## Instructions (cont'd)

3. Set the trigger switch to the SAFE (O) position until you are ready to use the handpiece.

NOTE: The handpiece has a variable speed motor that is controlled by slight pressure variations on the trigger.

### Battery Pack Removal

Depress the battery latch and pull the battery pack out.

### Attachment Removal

Slide the actuator button down and release the attachment.

## Attachments



### WARNINGS:

- Before attaching or removing any accessory or before passing the handpiece to another person, always set the trigger switch to the SAFE (O) position to prevent inadvertent running of the handpiece.
- Use only Stryker approved attachments. A list of accessories is available from your Stryker Instruments sales representative.

## 1/4" Chuck Attachments

Available in different gear ratios, 1/4" Chuck attachments hold wires, pins and drill bits up to 1/4 in. (6.4 mm) in diameter. Each attachment is supplied with a chuck key.

DESCRIPTION	REF
1:1 1/4" Keyed Chuck	4103-131-000
2:1 High Torque 1/4" Drill	4103-180-000
3.25:1 1/4" Keyed Chuck	4103-231-000

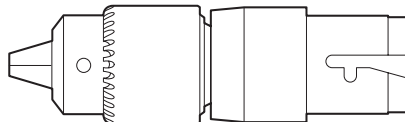

1/4" Chuck Attachment

### Tool Installation

1. Using the chuck key, open the chuck jaws.
2. Insert the tool (wire, pin or drill bit).
3. Using the chuck key, close the jaws.
4. Tug the tool to ensure that it is secure before running the handpiece.

## Attachments (cont'd)

### Keyless Style Attachments

These accessories hold wires, pins and bits up to 1/4 in. (6.4 mm) in diameter. The adaptor is used in accessories with Trinkle style retainers.

DESCRIPTION	REF
Keyless Chuck Adaptor	4103-082-131
1:1 Keyless Drill	4103-133-000

### Cutting Accessory Insertion



#### WARNINGS:

- You must manually close the chuck jaws to secure the accessory. Operating the handpiece to automatically close the jaws on the accessory may result in injury to the user.
1. To open the chuck jaws, hold the attachment with the knurled ring in one hand and turn the collar with the other hand (see illustration below).

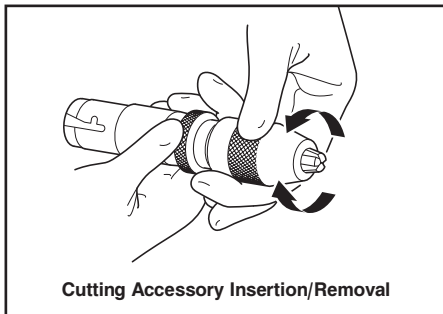

2. Insert the cutting accessory and ensure it is centered in the jaws.
3. To close the jaws, hold the collar and turn the knurled ring until it is tight.
4. Tug the cutting accessory to ensure it is secure.
5. Visually inspect the cutting accessory to ensure it is centered in the jaws.
6. Install the attachment in the handpiece.

### Drill Type Attachments

DESCRIPTION	REF
1:1 AO Small Drill	4103-110-000
1:1 Hudson	4103-113-000
1:1 Hudson Modified Trinkle	4103-135-000
1:1 Trinkle	4103-160-000

**1:1 AO Small Drill (REF 4103-110-000)** - Accepts Synthes tools such as drill bits, taps and automatic screwdrivers with the appropriate snap-lock shank.

**1:1 Hudson (REF 4103-113-000)** - Accepts tools with Hudson fittings.

**1:1 Hudson Modified Trinkle (REF 4103-135-000)**  
- Accepts tools such as drill bits and automatic screwdrivers with Hudson or modified Trinkle fittings.

**1:1 Trinkle (REF 4103-160-000)** - Accepts tools such as drill bits and automatic screwdrivers with standard Trinkle fitting.



## Attachments (cont'd)

### Reamer Type Attachments

DESCRIPTION	REF
3.25:1 AO Large Reamer	4103-210-000
3.25:1 Hudson	4103-213-000
3.25:1 Hudson/Modified Trinkle	4103-235-000
3.25:1 Trinkle	4103-260-000
4:1 Hudson/Modified Trinkle	4103-435-000

**3.25:1 AO Large Reamer (REF 4103-210-000)** - Accepts Synthes tools such as drill bits, automatic screwdrivers, and flexible reamers with the appropriate snap-lock shank. Provides low speed and high torque.

**3.25:1 Hudson (REF 4103-213-000)** - Accepts tools with Hudson fittings.

**3.25:1 Hudson/Modified Trinkle (REF 4103-235-000)** - In addition to holding drill bits and automatic screwdrivers, this attachment will hold flexible reamers with Hudson or Modified Trinkle fittings. Provides low speed and high torque.

**3.25:1 Trinkle (REF 4103-260-000)** - Accepts tools such as drill bits, automatic screwdrivers and flexible reamers with standard Trinkle fitting. Provides low speed and high torque.

**4:1 Hudson/Modified Trinkle (REF 4103-435-000)**

### Tool Installation

1. Slide back the retaining collar.
2. Insert the desired tool (drill bits, screwdrivers, reamers).
3. Release the retaining collar.
4. Tug the tool to ensure it is secure before running the handpiece.

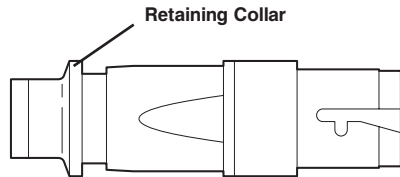

**Drill/Reamer Type Attachment**

## ***Troubleshooting Guidelines\****

<b><u>PROBLEM</u></b>	<b><u>CAUSE</u></b>	<b><u>ACTION</u></b>
Instrument does not run or turns at a reduced speed.	Battery pack is discharged.	Recharge the battery in Stryker charger.
	Battery pack is expended.	Replace the battery pack.
	Trigger switch is in the SAFE position.	Set the trigger switch out of the SAFE position.
Motor runs but accessory does not move.	Drivetrain is malfunctioning.	Return the handpiece for repair.
	Attachment is not fully seated.	Rotate the nose of the attachment during insertion into the handpiece.
Battery pack becomes unusually hot during use.	Circuitry is malfunctioning.	Check the battery pack on the Stryker charger and replace if indicated. See <i>Charger Instructions</i> .
Attachment will not fit into the handpiece.	Shaft is misaligned.	Rotate the nose of the attachment during insertion into the handpiece.
	Debris is inside the cannulated shaft or the front end of the handpiece.	Clean with a small brush.
	Attachment is damaged.	Return the attachment for repair.
	Handpiece is damaged.	Return the handpiece for repair.
"Wobble" occurs while using an accessory.	Bit or wire/pin is bent, extends too far from the distal end of attachment, is the wrong size, or is not properly centered.	Reinsert the bit or wire/pin. If wobble persists, this may indicate a problem with the attachment. Return attachment for repair.

\*This product is not field repairable. In case of operating difficulties, all Stryker products must be returned to Stryker Instruments for repair. For more information, contact your Stryker Instruments sales representative or call Stryker Customer Service at 1-800-253-3210. Outside the USA, contact your nearest Stryker subsidiary.

## ***Troubleshooting Guidelines (cont'd)***

<b><u>PROBLEM</u></b>	<b><u>CAUSE</u></b>	<b><u>ACTION</u></b>
Handpiece has become noisy and vibrates.	Drivetrain is malfunctioning.	Return the handpiece for repair.
Sporadic electrical interference is experienced.	Electrical noise is present.	Turn off all electrical equipment not in use in the operating room.  Relocate electrical equipment; increase spatial distance.  Plug operating room equipment into different operating room outlets.

---

## ***Periodic Maintenance***

<b><u>INTERVAL</u></b>	<b><u>ACTIVITY</u></b>
Prior to each use.	Inspect, operate and test the handpiece to ensure that it is working properly. Ensure that there are no loose or missing components. Check all moving parts for free movement. Be alert for unusual sounds or vibrations and note the operating speed.

## ***Storage and Handling***

To ensure the longevity, performance and safety of this equipment, package in original packaging materials when storing or transporting.

## Cleaning Recommendations



### WARNINGS:

- Handpieces, attachments and batteries must be cleaned and sterilized before first and every use.
- DO NOT use solvents, lubricants, or other chemicals unless otherwise specified.

**CAUTION:** DO NOT immerse the handpiece, attachments or battery pack.

### Battery Packs and Accessories

Refer to the *Cleaning Recommendations* for the battery packs, battery pack adaptors and chargers provided with those products.

### Handpiece and Attachments

1. Remove the battery pack and attachment from the handpiece.
2. Using a stiff bristle brush and mild detergent (hospital enzymatic cleaner), scrub the debris from the handpiece and attachments. Pay special attention to crevices and other hard to reach areas such as seams, joints, and details around the retainer and trigger areas. Use a bottle brush to clean the cannula.

**CAUTION:** DO NOT allow water to run directly into the battery contact area.

3. Rinse instruments under running water. Hold the handpiece upright to prevent water from running into the battery contact area. Flush the cannula with running water.
4. If water leaks into the handpiece, tip the handpiece back as shown below to allow drainage from a small opening in the battery contact area.

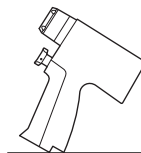

### Draining Water From Handpiece

5. Visually inspect the handpieces for any remaining debris; if any is present, repeat the cleaning and rinsing procedure using fresh hospital enzymatic cleaner.
6. Dry the handpiece and attachments with a lint-free towel.
7. After cleaning, sterilize as directed. See *Sterilization Recommendations*.

## ***Sterilization Recommendations***



### **WARNINGS:**

- Handpieces, attachments and batteries must be cleaned and sterilized before first and every use.
- Remove the battery and attachment from the handpiece prior to sterilization. Fully open the jaws of the chucks before sterilizing these attachments.

### **Battery Packs**

Refer to the *Sterilization Recommendations* information provided with the battery packs.

### **Handpieces and Attachments**

To obtain optimum performance from the instruments and help prevent damage to the instruments, it is essential that one of the following sterilization procedures be performed.

#### **“Flash” Autoclave:**

- Gravity displacement sterilizer
- 270-272°F (132-134°C)
- Unwrapped in an instrument tray in a vertical position so steam can flow through the cannula
- 10-minute minimum exposure time

#### **Hi Vac:**

- Pre-vacuumed sterilizer
- 270-272°F (132-134°C)
- Wrapped or unwrapped
- 4-minute minimum exposure time
- 8-minute minimum dry time

#### **ETO:**

- 100% ETO
- 120-135°F (49-57°C)
- Wrapped in an instrument tray or fully perforated sterilization box
- 2-hour 30-minute exposure time, 8-hour minimum aeration time

#### **250°F Gravity:**

- Gravity displacement sterilizer
- 250-254°F (121-123°C)
- Wrapped in an instrument tray or fully perforated sterilization box
- 50-minute exposure time
- 8-minute minimum drying time

#### **270°F Gravity:**

- Gravity displacement sterilizer
- 270-272°F (132-134°C)
- Wrapped in an instrument tray or fully perforated sterilization box
- 35-minute minimum exposure time
- 8-minute minimum dry time

Sterilization Recommendations  
Validation based on AAMI protocol.

# Specifications\*

**Model:** REF 4203-000-000 Rotary Handpiece

---

**Size:** 8.25 in. [210 mm] height (with battery)  
1.60 in. [41 mm] width  
5.20 in. [132 mm] length

---

**Weight:** 3 lbs. [1.36 kg] (with battery)

---

**Speed:** 900 RPM (maximum)

---

**Duty Cycle:**  Intermittent Operation - 1 minute on/ 4 minutes off 5 times with 3 hour rest

---

**Approvals:**  CSA International  
CAN/CSA-C22.2 No. 601.1-M90  
UL 60601-1  
IEC 60601-1

---

**Equipment Type:**  Type BF Applied Part

---





**Power Supply:** Internally Powered

---

**Enclosure Protection:** IPX0 Ordinary Equipment

---

**Environmental Conditions:** **Operation** **Storage and Transportation**

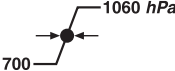
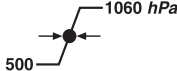
<b>Temperature:</b>		
<b>Relative Humidity:</b>		
<b>Atmospheric Pressure:</b>		

---

\*Specifications listed are approximate and may vary slightly from unit to unit or by power supply fluctuations.

**Guidance and manufacturer's declaration - electromagnetic emissions**

The System 5 handpiece is intended for use in the electromagnetic environment specified below. The customer or the user of the System 5 handpiece should assure that it is used in such an environment.

<b>Emissions test</b>	<b>Compliance</b>	<b>Electromagnetic environment - guidance</b>
RF emissions CISPR 11	Group 1	The System 5 handpiece uses RF energy only for its internal function. Therefore, its RF emissions are very low and are not likely to cause any interference in nearby electronic equipment.
RF emissions CISPR 11	Class B	
Harmonic emissions  IEC 61000-3-2	n/a	
Voltage fluctuations/flicker emissions  IEC 61000-3-3	n/a	

**Guidance and manufacturer's declaration - electromagnetic immunity**

The System 5 handpiece is intended for use in the electromagnetic environment specified below. The customer or the user of the System 5 handpiece should assure that it is used in such an environment.

Immunity test	IEC 60601 test level	Compliance level	Electromagnetic environment - guidance
<p>Conducted RF IEC 61000-4-6</p>	<p>3 Vrms 150 kHz to 80 MHz</p>	<p>n/a n/a</p>	<p>Portable and mobile RF communications equipment should be used no closer to any part of the System 5 handpiece, including cables, than the recommended separation distance calculated from the equation applicable to the frequency of the transmitter.</p> <p>Recommended separation distance</p> $d=1.67\sqrt{P}$ <p>80 MHz to 800 MHz</p> $d=2.33\sqrt{P}$ <p>800 MHz to 2.5 GHz</p> <p>Where <math>P</math> is the maximum output power rating of the transmitter in watts (<math>W</math>) according to the transmitter manufacturer and <math>d</math> is the recommended separation distance in meters (m)</p> <p>Interference may occur in the vicinity of equipment marked with the following symbol:</p> 
<p>Radiated RF IEC 61000-4-3</p>	<p>3 V/m 80 MHz to 2.5 GHz</p>	<p>3 V/m 80 MHz to 2.5 GHz</p>	

NOTE 1: At 80 MHz and 800MHz the higher frequency range applies.

NOTE 2: These guidelines may not apply in all situations. Electromagnetic propagation is affected by absorption and reflection from structures, objects and people.



**Guidance and manufacturer's declaration - electromagnetic immunity**

The System 5 handpiece is intended for use in the electromagnetic environment specified below. The customer or the user of the System 5 handpiece should assure that it is used in such an environment.

<b>Immunity test</b>	<b>IEC 60601 test level</b>	<b>Compliance level</b>	<b>Electromagnetic environment - guidance</b>
Electrostatic discharge (ESD)  IEC 61000-4-2	±6 kV contact  ±8 kV air	±2, 4, 6 kV contact  ±2, 4, 8 kV air	Floors should be wood, concrete or ceramic tile. If floors are covered with synthetic material, the relative humidity should be at least 30%.
Electrical fast transient/burst  IEC 61000-4-4	±2 kV for power supply lines  ±1 kV for input/output lines	n/a  n/a	
Surge  IEC 61000-4-5	±1 kV differential mode  ±2 kV common mode	n/a  n/a	
Voltage dips, short interruptions and voltage variations on power supply input lines  IEC 61000-4-11	<5% $U_T$ (>95% dip in $U_T$ ) for 0,5 cycle  40% $U_T$ (60% dip in $U_T$ ) for 5 cycles  70% $U_T$ (30% dip in $U_T$ ) for 25 cycles  <5% $U_T$ (>95% dip in $U_T$ ) for 5 sec	n/a  n/a  n/a  n/a	
Power frequency (50/60 Hz) magnetic field  IEC 61000-4-8	3 A/m	3 A/m	Power frequency magnetic fields should be at levels characteristics of a typical location in a typical commercial or hospital environment.

NOTE:  $U_T$  is the a.c. mains voltage prior to application of the test level.

**Recommended separation distances between portable and mobile RF communications equipment and the System 5 handpiece**

The System 5 handpiece is intended for use in the electromagnetic environment in which radiated RF disturbances are controlled. The customer or the user of the System 5 handpiece can help prevent electromagnetic interference by maintaining a minimum distance between portable and mobile RF communications equipment (transmitters) and the System 5 handpiece as recommended below, according to the maximum output power of the communications equipment.

Rated maximum output power of transmitter  W	Separation distance according to frequency of transmitter m		
	150 kHz to 80 MHz	80 MHz to 800 MHz	800 MHz to 2.5 GHz
	$d = \left[ \frac{3.5}{V_1} \right] \sqrt{P}$	$d = \left[ \frac{3.5}{E_1} \right] \sqrt{P}$	$d = \left[ \frac{7}{E_1} \right] \sqrt{P}$
0.01	n/a	0.12	0.23
0.1	n/a	0.37	0.74
1	n/a	1.17	2.33
10	n/a	3.70	7.37
100	n/a	11.70	23.30

For transmitters rated at a maximum output power not listed above, the recommended separation distance  $d$  in meters (m) can be estimated using the equation applicable to the frequency of the transmitter, where  $P$  is the maximum output power rating of the transmitter in watts (W) according to the transmitter manufacturer.

NOTE 1: At 80 MHz and 800MHz, the separation distance for the higher frequency range applies.

NOTE 2: These guidelines may not apply in all situations. Electromagnetic propagation is affected by absorption and reflection from structures, objects and people.

## ***Repair and Loaner Program***

This service is available in the United States only. Outside the USA, contact your Stryker sales representative or nearest Stryker subsidiary.

On request, Stryker Instruments will provide a loaner unit for your use while repairs are being made. Please clean and sterilize all potentially contaminated products being sent in for repair, credit, or return of a loaner unit. The policy of Stryker Instruments is not to accept or process potentially contaminated products that do not meet this requirement.

Also, please be aware that it is unlawful to transport bio-contaminated products through interstate commerce that are not properly packaged and labeled as such.

1. Contact Stryker Customer Service at 1-800-253-3210 to request a loaner. Provide a name and address for shipping. Every effort will be made to send a loaner unit immediately.
2. Send the inoperative unit to Stryker with a purchase order number of authorization for repair. The order should explain the nature of the difficulty. Also, provide a name and address for shipping the repaired instruments.

Return the inoperative unit to:

**Stryker Instruments  
Repair Department  
4100 E. Milham  
Kalamazoo, Michigan, 49001**

3. The repaired unit will be shipped back and the repair invoice will follow under separate cover. Under most conditions, repair turnaround time will be approximately 2 to 3 weeks.
4. As soon as your repaired unit is returned, return the loaner to Stryker Instruments.

## ***Limited Warranty***

In the U.S.A. only, products of Stryker Instruments are warranted to the original purchaser for a period of one year from the date of purchase, with exceptions noted below. Products are warranted to be free from defects in material and workmanship. Abnormal wear and tear or damage caused by misuse or by failure to perform normal and routine maintenance as set out in these instructions, or as demonstrated by an authorized Stryker Instruments representative, is not covered by the warranty. Any effort at field repair or adjustment may invalidate your warranty.

The warranty extends to all purchasers and is limited to the repair or replacement of the product without charge when returned prepaid to Stryker Instruments. There are no other expressed warranties. This warranty gives you specific legal rights and you may have other rights which vary by state and municipality.

For selected products: Battery Packs are warranted for a period of 90 days from the date of invoice.



ES/DE/FR/IT/NL  
JA/ZH/KO  
SV/DA/FI/PT  
PL/EL

4203-001-713  
4203-001-720  
4203-001-730  
4203-001-750



**Stryker Instruments**  
4100 E. Milham  
Kalamazoo, Michigan  
(USA) 49001  
1-269-323-7700  
1-800-253-3210



Stryker France  
ZAC Satolas Green Pusignan  
Av. de Satolas Green  
69881 MEYZIEU Cedex  
France